

Copyright is owned by the Author of the thesis. Permission is given for a copy to be downloaded by an individual for the purpose of research and private study only. The thesis may not be reproduced elsewhere without the permission of the Author.

THE EPIDEMIOLOGY OF INFECTIONS
BY
STREPTOCOCCUS SUIS TYPES 1 AND 2

A thesis presented in partial fulfilment of the requirements for the degree of Doctor of Philosophy in Veterinary Pathology and Public Health at Massey University.

Ian Duncan Robertson

1988

ABSTRACT

An Indirect Fluorescent Antibody Test (I.F.A.T.) was developed for the identification of carriers of Streptococcus suis. This test was more accurate than the "traditional" cultural techniques. The sensitivity for detecting S. suis type 1 from tonsillar swabs was 62%, and 76% for S. suis type 2. For nasal swabs collected from live pigs the sensitivity was 48% and 60% respectively.

From the examination of 959 non specific pathogen free domesticated pigs from 63 herds, 263 specific pathogen free (SPF) pigs from seven herds and 96 feral pigs it is concluded that all non-SPF domesticated pigs older than five weeks of age are infected with both S. suis types 1 and 2. Variation in the apparent prevalence of infection between different herds was associated with the number of pigs sampled in each herd rather than a real variation in the prevalence and was similar in both New Zealand and Australian non-SPF domesticated pigs. Three of seven SPF herds tested in Australia were free from infection with S. suis types 1 and 2. It is proposed that all SPF pigs are delivered free from infection and that infection is subsequently introduced into the piggery.

Streptococcus suis was detected from numerous tissues and fluids including the blood of normal pigs. It is suggested that the isolation of S. suis from "diseased" tissue does not infer that S. suis was the primary aetiological agent.

Although both S. suis types 1 and 2 were readily detected in the environment of pigs housed in an intensive piggery, the main routes of transmission were considered to be direct contact or neonatal infection of piglets born to sows with vaginal infections.

Based on serological results from using an Enzyme Linked Immunosorbent Assay (ELISA), the pattern of infection due to S. suis types 1 and 2 was similar in domestic pigs. In feral pigs the pattern of infection due to S. suis type 2 was similar to that of domestic pigs, but in the case of S. suis type 1 the prevalence and titres were considerably lower in feral pigs. It is concluded from these results,

that both domestic and feral pigs are true long term carriers of S. suis type 2 whilst S. suis type 1 is maintained within a population by a series of reinfections dependent on the population density.

There was no evidence of ascending uro-genital infection or signs of clinical disease in 24 bacon weight pigs inoculated with S. suis type 1 or 2 by either the intravaginal or intrapreputial routes. When two litters of previously non-infected pigs were intranasally inoculated with S. suis, no pigs developed clinical signs. The results of this experiment showed that the infective dose was less than 100 organisms by this route. Only one of eight pigs developed "classical" clinical signs after intravenous inoculation with a porcine isolate of S. suis type 2. Some pigs remained apparently normal even though high numbers of organisms were present in the blood for up to two weeks. Only two of fourteen pigs inoculated with S. suis type 2 into the cerebro-spinal fluid (C.S.F.) developed signs of clinical disease. Both these pigs were inoculated with a human strain of S. suis type 2. To explain these results it is proposed that strains of S. suis of different pathogenicity exist. This hypothesis was supported by the findings that this human strain was also pathogenic for mice, rats and rabbits whilst the porcine isolate was pathogenic only for rabbits.

A cross-sectional study of various occupational groups showed a positive correlation between contact with pigs and being seropositive to S. suis type 2. No veterinary students, 10.3% of meat inspectors, 14% of dairy farmers who also kept pigs and 21.4% of pig farmers were seropositive. In exposed pig farmers the annual incidence of sero-conversion could be as high as 30%. It is believed that subclinical infection of humans, as well as pigs, occurs and that isolates pathogenic for pigs are also pathogenic for other species of animals including man.

It is hypothesized that S. suis is endemic in pigs at a prevalence rate approaching 100% in all countries where pigs are kept. The pathogenicity of isolates can vary and this could account for variations in the severity of disease reported throughout the world. It is concluded that S. suis is usually a commensal and is involved in a disease process only when pathogenic strains are present and after some other primary insult.

ACKNOWLEDGEMENTS

The work reported in this thesis would not have been possible without the encouragement, support and financial assistance of many people and organizations.

Financial support was gratefully received from the Pig Research Council (Australia); the Veterinary Research Fund, Massey University, New Zealand; and the Queensland Department of Primary Industries. Professor B.W. Manktelow kindly made available the facilities of the Department of Veterinary Pathology and Public Health, Massey University.

The assistance, constructive criticism, enthusiasm, friendship and enquiring mind of my main supervisor Professor David Blackmore were sincerely appreciated. My second supervisor, Dr. Roger Marshall, provided further support and ideas for this project.

Many people contributed to make my stay at Massey University an enjoyable, friendly, yet fulfilling time. These included Lynne Cullinane and Robert Holdaway who, with their technical advice, put extra fun into microbiology; Jan Schrama who prepared the media, glassware and cheered up the day; Dr. David Hampson and Zhenfang Fu (post-graduate student) who helped with the handling of pigs in the cohort study, appraised ideas and offered helpful advice; Lynley Denby who assisted with the ELISA; Aki Shimada (post-graduate student) who gave advice on the interpretation of histopathological sections; Peter Winter who performed the bacterial restriction endonuclease DNA analysis (BRENDA); Liz Davies who assisted with the haematology; Peter Wildbore who ordered goods and helped spend the money; Tom Law who took photographic evidence of the work; Brian Pickett who offered advice on the intricacies and anomalies of computers and Mr. Rick Webster (Senior Veterinary Officer) who gave information on the disease in Australia.

With the experimental animals, Dr. Keith Lapwood and Mr. Boyd Jones (Clinical Veterinarian) offered advice on the surgical procedures and Irene Hall capably and cheerfully assisted with the

anaesthesia of these pigs. Professor David Blackmore and Dr. Linda Schollum must also be thanked for allowing the use of sera collected from humans with different occupations and from feral pigs.

Special thanks also must go to Phil Weber, Kit Jameson, Graham Pearson, Dr. Bill Smith and Dr. Paul Moughan who made available the facilities of Massey Piggery, helped and assisted with handling of pigs and calmly coped with the chaos I created. The staff of Kiwi Bacon Factory, KR Darling Downs, Queensland Bacon and The Metropolitan Public Abattoir and the inspectors of the Ministry of Agriculture and Fisheries, New Zealand and the Commonwealth Department of Primary Industries and Energy, Australia are also thanked for the way they included me into their everyday routine and allowed the collection of so many samples.

A special thanks must go to my wife Cathy and children Mike and Jenny for being so understanding when I've come home smelling of pigs, spent hours being anti-social on the computer, for struggling to hold experimental pigs whilst they were being bled and most importantly for their love and support.

TABLE OF CONTENTS

| | Page Number |
|---|-------------|
| Abstract | ii |
| Acknowledgements | iv |
| Table of Contents | vi |
| List of Figures | viii |
| List of Plates | xi |
| List of Tables | xii |
| Chapter I : Introduction | 1 |
| Chapter II : Literature Review | 3 |
| Chapter III : Development of Microbiological and Serological Techniques | 36 |
| Chapter IV : Survival of <u>Streptococcus suis</u> | 91 |
| Chapter V : The Prevalence of <u>Streptococcus suis</u> in Pigs. The Results of a Cross-Sectional Survey. | 122 |
| Chapter VI : A Longitudinal Survey of Infection with <u>Streptococcus suis</u> . | 149 |
| Chapter VII : Experimental Infection with <u>Streptococcus suis</u> | 175 |
| Chapter VIII : Public Health Aspects of <u>Streptococcus suis</u> type 2 | 251 |

| | | |
|------------|---|-----|
| Chapter IX | : The Prevalence of <u>Streptococcus suis</u> in Queensland Pigs | 267 |
| Chapter X | : General Discussion | 278 |
| References | | 289 |
| Appendices | | 315 |

LIST OF FIGURES

| Figure | | Page Number |
|--------|--|-------------|
| 3.1 | Position of organisms and antibiotic discs for sensitivity tests | 44 |
| 3.2 | Antibiotic sensitivity of <u>S. suis</u> | 45 |
| 3.3 | Comparison of ELISA readings at different dilutions of pig sera and conjugate against antigen of <u>S. suis</u> type 1 and "no-antigen" controls | 83 |
| 3.4 | Comparison of ELISA readings at different dilutions of pig sera and conjugate against antigen of <u>S. suis</u> type 2 and "no-antigen" controls | 84 |
| 3.5 | Comparison of ELISA readings at different dilutions of human sera and conjugate against antigen of <u>S. suis</u> type 2 and "no-antigen" controls | 85 |
| 3.6 | Comparison of ELISA activities at different bacterial antigen (<u>S. suis</u> type 1) concentrations against different pig serum dilutions | 86 |
| 3.7 | Comparison of ELISA activities at different bacterial antigen (<u>S. suis</u> type 2) concentrations against different pig serum dilutions | 87 |
| 3.8 | Comparison of ELISA activities at different bacterial antigen (<u>S. suis</u> type 2) concentrations against different human serum dilutions | 88 |
| 4.1 | The effect of pH solutions on the survival of a field isolate of <u>S. suis</u> type 2 | 104 |
| 4.2 | The effect of pH solutions with 5% faeces on the survival of a field isolate of <u>S. suis</u> type 2 | 104 |
| 4.3 | The effect of pH solutions on the survival of a field isolate of <u>S. suis</u> type 1 | 105 |
| 4.4 | The effect of pH solutions with 5% faeces on the survival of a field isolate of <u>S. suis</u> type 1 | 105 |
| 4.5 | The effect of temperature on the survival of a field isolate of <u>S. suis</u> type 2 in physiological saline | 107 |
| 4.6 | The effect of temperature on the survival of a strain culture of <u>S. suis</u> type 2 in physiological saline | 107 |

| Figure | | Page Number |
|--------|--|-------------|
| 4.7 | The effect of temperature on the survival of a field isolate of <u>S. suis</u> type 1 in physiological saline | 108 |
| 4.8 | The effect of temperature on the survival of a strain culture of <u>S. suis</u> type 1 in physiological saline | 108 |
| 4.9 | The effect of temperature on the survival of <u>S. suis</u> type 2 in physiological saline with 5% faeces | 109 |
| 4.10 | The effect of temperature on the survival of <u>S. suis</u> type 1 in physiological saline with 5% faeces | 109 |
| 4.11 | The effect of saline solutions on the survival of a field isolate of <u>S. suis</u> type 2 | 111 |
| 4.12 | The effect of saline solutions with 5% yeast on the survival of a field isolate of <u>S. suis</u> type 2 | 111 |
| 4.13 | The effect of saline solutions on the survival of a field isolate of <u>S. suis</u> type 1 | 112 |
| 4.14 | The effect of saline solutions with 5% yeast on the survival of a field isolate of <u>S. suis</u> type 1 | 112 |
| 5.1 | Range of titres to <u>S. suis</u> types 1 and 2 in pigs | 135 |
| 6.1 | Handling of pigs in litters under study | 152 |
| 6.2 | The temporal pattern of infection with <u>S. suis</u> type 1 | 156 |
| 6.3 | The temporal pattern of infection with <u>S. suis</u> type 2 | 157 |
| 6.4 | The proportion of carriers of <u>S. suis</u> types 1 and 2 in pigs housed under different conditions | 159 |
| 6.5 | Infection and the development of antibodies to <u>S. suis</u> type 1 | 164 |
| 6.6 | Infection and the development of antibodies to <u>S. suis</u> type 2 | 164 |
| 6.7 | Change in antibody titre to <u>S. suis</u> type 1 in a cohort of pigs | 166 |
| 6.8 | Change in antibody titre to <u>S. suis</u> type 2 in a litter of pigs | 167 |

| Figure | | Page Number |
|--------|---|-------------|
| 7.1 | Spread of infection of <u>S. suis</u> types 1 and 2 in a litter intranasally infected with 10 ⁹ organisms | 198 |
| 7.2 | Spread of infection of <u>S. suis</u> types 1 and 2 in a litter intranasally infected with 10 ¹⁰ organisms | 199 |
| 7.3 | Total white cell counts of pigs intravenously infected with <u>S. suis</u> type 2 | 222 |
| 7.4 | Antibody titre to <u>S. suis</u> type 1 in pigs intravenously infected with <u>S. suis</u> type 2 | 224 |
| 7.5 | Antibody titre to <u>S. suis</u> type 2 in pigs intravenously infected with <u>S. suis</u> type 2 | 225 |
| 8.1 | The range of titres to <u>S. suis</u> type 2 in different occupational groups | 256 |
| 10.1 | Temporal variation of prevalence and incidence of infection with <u>S. suis</u> in a group of pigs | 282 |

LIST OF PLATES

| Plate | | Page Number |
|-------|--|-------------|
| 3.1 | The haemolysis of <u>S. suis</u> type 2 on sheep blood agar | 47 |
| 3.2 | A Gram stain of <u>S. suis</u> type 2 | 47 |
| 3.3 | The moisture chamber used in the immunofluorescent tests | 60 |
| 3.4 | <u>S. suis</u> type 2 stained with an I.F.A.T. | 60 |
| 7.1 | Cannulae used for jugular catheterization | 212 |
| 7.2 | Directing the cannula from the jugular vein to the dorsal midline | 212 |
| 7.3 | Flushing of the cannula with heparinized saline | 213 |
| 7.4 | The pig following jugular catheterization with a stretch-stocking to prevent the cannulae | 213 |
| 7.5 | Radiograph of the pig head for positioning of the needle into the subarachnoid space | 231 |
| 7.6 | Positioning of the needle in the subarachnoid space | 231 |
| 7.7 | Pig with signs of paddling and opisthotonus after injection with the human isolate of <u>S. suis</u> type 2 into the C.S.F. | 236 |
| 7.8 | Meningitis observed in a pig without clinical signs infected with the human isolate of <u>S. suis</u> type 2 into the C.S.F. | 238 |
| 7.9 | A glial nodule in a pig without clinical signs after infection with a porcine isolate of <u>S. suis</u> type 2 | 238 |

LIST OF TABLES

| Table | | Page Number |
|-------|---|-------------|
| 2.1 | Proportion (%) of different Lancefield groups of streptococci isolated from pigs | 5 |
| 2.2 | Reported morbidity and mortality due to <u>S. suis</u> infection in pigs | 8 |
| 2.3 | Major pathological lesions (%) of pigs associated with infection by <u>S. suis</u> type 1 | 12 |
| 2.4 | Major pathological lesions (%) of pigs associated with infection by <u>S. suis</u> type 2 | 13 |
| 2.5 | Isolation of other bacteria from pneumonic lungs from which <u>S. suis</u> had been isolated (%) | 14 |
| 2.6 | Reported isolation rates of <u>Streptococcus suis</u> from various sites in pigs | 19 |
| 2.7 | Reported isolation rates of <u>Streptococcus suis</u> type 2 from herds fed antibiotics (Clifton-Hadley and Alexander, 1984a) | 25 |
| 3.1 | Biochemical and physiological characteristics of <u>Streptococcus suis</u> types 1 and 2 | 38 |
| 3.2 | The biochemical and growth characteristics of <u>Streptococcus suis</u> types 1 and 2 | 48 |
| 3.3 | Sensitivity of <u>S. suis</u> to antibiotics | 50 |
| 3.4 | Fluorescence of <u>S. suis</u> type 1 at various dilutions of conjugate and antisera | 59 |
| 3.5 | Fluorescence of <u>S. suis</u> type 2 at different concentrations of group R conjugate and antiserum | 59 |
| 3.6 | Specificity of the I.F.A.T. for <u>S. suis</u> type 2 with group R antiserum | 62 |
| 3.7 | Specificity of the I.F.A.T. for <u>S. suis</u> type 1 with group S antiserum | 62 |
| 3.8 | Comparison of cultural and immunofluorescent tests (I.F.A.T.) for the detection of <u>S. suis</u> type 2 | 63 |
| 3.9 | Comparison of cultural and immunofluorescent tests for the detection of <u>S. suis</u> type 1 | 63 |
| 3.10 | Comparison of cultural and immunofluorescent tests on nasal swabs for <u>S. suis</u> type 2 | 64 |

| Table | Page Number |
|--|-------------|
| 3.11 Comparison of cultural and immunofluorescent tests on nasal swabs for <u>S. suis</u> type 1 | 64 |
| 3.12 Comparison of nasal and tonsillar swabs for detecting <u>S. suis</u> type 2 with the I.F.A.T. | 66 |
| 3.13 Comparison of nasal and tonsillar swabs for the detection of <u>S. suis</u> type 1 with the I.F.A.T. | 66 |
| 3.14 Comparison of 5% sheep blood agar with Edwards medium for the detection of tonsillar carriers of <u>S. suis</u> type 2 using I.F.A.T. | 67 |
| 3.15 Comparison of 5% sheep blood agar with Edwards medium for the detection of tonsillar carriers of <u>S. suis</u> type 1 using I.F.A.T. | 67 |
| 3.16 The number of pigs to sample to be 95% confident of detecting the presence of infection with <u>S. suis</u> | 73 |
| 4.1 Detection of <u>S. suis</u> types 1 and 2 by immunofluorescence from the piggery environment | 93 |
| 4.2 Detection (%) of <u>S. suis</u> type 2 by I.F.A.T. from palatine tonsils stored at 4°C and room temperature | 98 |
| 4.3 Detection (%) of <u>S. suis</u> types 1 and 2 by I.F.A.T. from palatine tonsils stored at -20°C | 98 |
| 4.4 Capacity-use disinfectant test results for <u>S. suis</u> incorporating 5% yeast | 114 |
| 5.1 Isolation rate of <u>S. suis</u> type 2 from the palatine tonsils of slaughtered pigs | 125 |
| 5.2 Isolation rate of <u>S. suis</u> type 1 from the palatine tonsils of slaughtered pigs | 126 |
| 5.3 Age (class) specific rates of infection with <u>S. suis</u> in the palatine tonsils of slaughtered pigs | 129 |
| 5.4 Isolation of <u>S. suis</u> from samples other than the palatine tonsil collected from slaughtered pigs | 130 |
| 5.5 The prevalence of uteri infected with <u>S. suis</u> detected at the meatworks | 131 |
| 5.6 The prevalence of nasal chambers infected with <u>S. suis</u> in live pigs | 131 |
| 5.7 Isolation of <u>S. suis</u> from sites other than the nose in live pigs | 133 |
| 5.8 Isolation of <u>S. suis</u> from the vaginas of live pigs | 133 |

| Table | Page Number | |
|-------|--|-----|
| 5.9 | prevalence of bacteraemia due to <u>S. suis</u> in live pigs | 134 |
| 5.10 | Geometric mean titres to <u>S. suis</u> in feral pigs | 137 |
| 6.1 | The reproductive history and detection of <u>S. suis</u> in sows used in the cohort study | 154 |
| 6.2 | The detection of <u>S. suis</u> type 1 in nasal and vaginal swabs of sows <u>after</u> farrowing | 155 |
| 6.3 | The detection of <u>S. suis</u> type 2 in nasal and vaginal swabs of sows <u>after</u> farrowing | 155 |
| 6.4 | The mean age at which pigs first become infected with <u>S. suis</u> types 1 and 2 | 160 |
| 6.5 | I.F.A.T. results from piglets examined <u>post mortem</u> | 161 |
| 6.6 | Isolation of <u>S. suis</u> types 1 and 2 from the environment of <u>the</u> study piglets | 163 |
| 7.1 | Summary of transmission experiments of Swe (1976) | 181 |
| 7.2 | Summary of transmission experiments of Clifton-Hadley and Alexander (1981) | 182 |
| 7.3 | Isolation of <u>S. suis</u> type 1 from the reproductive tract of artificially infected pigs | 187 |
| 7.4 | Isolation of <u>S. suis</u> type 2 from the reproductive tract of artificially infected pigs | 189 |
| 7.5 | The recovery of <u>S. suis</u> type 2 from the blood and liver after intravenous inoculation | 206 |
| 7.6 | <u>Numbers</u> of <u>S. suis</u> type 2 isolated from the blood after intravenous infection | 216 |
| 7.7 | Macroscopic lesions detected in pigs infected with <u>S. suis</u> type 2 via the intravenous route | 218 |
| 7.8 | Microbiological findings from pigs infected with <u>S. suis</u> type 2 via the intravenous route | 219 |
| 7.9 | Histopathological findings in pigs infected with <u>S. suis</u> type 2 by the intravenous route | 220 |
| 7.10 | Clinical, microbiological and pathological findings of subarachnoid inoculation with <u>S. suis</u> type 2 | 233 |
| 7.11 | A summary of the findings in laboratory animals inoculated with <u>S. suis</u> | 244 |

| Table | Page Number | |
|-------|---|-----|
| 8.1 | Prevalence of positive titres to <u>S. suis</u> type 2 in different occupational groups | 257 |
| 8.2 | The relationship between potential risk factors and titres to <u>S. suis</u> type 2 | 258 |
| 8.3 | The number of positive titres to <u>S. suis</u> type 2 in different age and occupational groups | 261 |
| 9.1 | Isolation rate of <u>S. suis</u> type 1 from the palatine tonsils of domesticated non-SPF Australian slaughtered pigs | 269 |
| 9.2 | Isolation rate of <u>S. suis</u> type 2 from the palatine tonsils of domesticated non-SPF Australian slaughtered pigs | 270 |
| 9.3 | Isolation rate of <u>S. suis</u> type 1 from the palatine tonsils of SPF slaughtered pigs | 272 |
| 9.4 | Isolation rate of <u>S. suis</u> type 2 from the palatine tonsils of SPF slaughtered pigs | 272 |
| 9.5 | The prevalence of infection with <u>S. suis</u> in pigs of different origin | 273 |
| 9.6 | Age (class) specific rates of infection with <u>S. suis</u> in the palatine tonsils of slaughtered pigs | 274 |

CHAPTER I

INTRODUCTION

With the shift from extensive farming of pigs to intensively reared and housed pigs, there have been significant changes in the pig industry. This move to fully enclosed housing and the associated "closing" of herds to limit the introduction of new pigs has resulted in a shift in the relative importance of particular diseases. The intensification of pig herds has reduced the exposure of pigs to some diseases associated with "open" herds such as Swine Fever, reduced the importance of diseases related to an uncontrolled environment such as infections with Ascaris suum, whilst the control of swill feeding has reduced their exposure to many potential zoonotic and exotic diseases. However except for strict specific pathogen free herds, the increased concentration of pigs within a building has facilitated the spread of infections including mycoplasmas, rota virus, enteropathogenic strains of E. coli, Yersinia enterocolitica and S. suis. Some of these organisms such as enteropathogenic E. coli result in obvious clinical disease, while others although highly endemic such as Yersinia enterocolitica may cause little clinical effect but be of importance to public health.

Infection with Streptococcus suis is now recognized as one of the most important bacterial diseases of pigs in many countries of the world (Clifton-Hadley and Alexander, 1984). Streptococcus suis type 2 can also cause a serious disease in humans. Although human disease has been reported to occur rarely in western countries, it has been suggested that S. suis is a possible emerging zoonoses (Ayanwale, 1986). Streptococcus suis has also been reported to occasionally cause disease in other animal species (Anon, 1978b; Keymer et al, 1983).

As the author was interested in, and had some experience with diseases of pigs, and was also interested in epidemiology and public health, the problems related to infection with S. suis offered the potential to use epidemiological techniques to investigate a disease of pigs which also was a zoonosis of apparently increasing importance.

Streptococcus suis appeared to be an intriguing and fascinating organism because first, it was one of the few porcine zoonotic agents present in New Zealand and Australia. Secondly, it was apparently different to other streptococci which are usually host-specific and therefore rarely zoonotic. Finally, although disease due to S. suis is a serious cause of pig mortality in the United Kingdom, it was not recognized as of major importance in Australia (Webster, pers. comm.), and before the work reported in this thesis it was not known if the disease was present in New Zealand. Preliminary studies suggested that the bacterium was present in a high proportion of New Zealand pigs. These findings stimulated the present work in an attempt to answer the following preliminary questions: Was clinical disease present in pigs in New Zealand? Was the pattern of infection in pigs similar to that reported from other countries? Obviously if major differences in the pattern of infection with S. suis occurred between New Zealand and Australia, and other countries, the reasons for such differences would need to be investigated further.

Initially, precise and accurate bacteriological and serological techniques had to be developed. However the emphasis of the present work is on the ecology of S. suis and the epidemiology of infection, rather than a bacteriological study of the organism. Thus the main objective of the work in this thesis was to investigate factors causally associated with infections by S. suis in animals and humans. The ways in which attempts were made to achieve this goal will be outlined and discussed.

The next chapter, a literature review, attempts to illustrate the pattern of infection with S. suis in pigs as well as the public health significance of the bacterium. More detailed reviews of particular aspects of S. suis will precede specific chapters.

The work recorded in this thesis is essentially in four parts; development of techniques to determine the true prevalence and incidence of infection, the ecology of S. suis, the epidemiology of infection and the public health aspects of this organism.

CHAPTER II

LITERATURE REVIEWHISTORY OF STREPTOCOCCUS SUIS

The genus Streptococcus contains organisms that are among the most important bacterial pathogens of man and animals (Woods and Ross, 1976). Streptococci may be free-living, commensals or act as primary pathogens (Finegold et al, 1978; Soltys, 1979). They can inhabit the mucous membranes of the mouth and nose, the lower urogenital tract, the alimentary tract and also the skin of both man and animals (Hill and Matsen, 1977; Windsor, 1978). Streptococci have been isolated from a wide variety of tissues and disease conditions in pigs of all ages (Woods and Ross, 1976; Schoon, 1983). Representatives of most Lancefield groups, as well as many strains that could not be typed, have been isolated from the tissues of diseased pigs (Shuman and Ross, 1975). The pathogenic significance of streptococci isolated from pigs, has often been difficult to determine because of the wide range in types of streptococci, the high prevalence in mucous membrane secretions and their frequent isolation in mixed cultures with other bacteria (Ross, 1972).

Streptococcus suis types 1 and 2, which belong to Lancefield's groups S and R respectively, were first described by De Moor (1963). He isolated these characteristic streptococci from pigs with septicaemia. It would appear that the same species of streptococci had previously been isolated from pigs with signs of septicaemia (Hare et al, 1942; Bryant, 1945; Ray, 1945), meningo-encephalitis (McNutt and Packer, 1943), endocarditis (Kernkamp, 1941; Hont and Banks, 1944) and arthritis (Sekiguchi and Irons, 1917). However using the antisera available at the time, these early isolates could not be typed by the Lancefield grouping method (Lancefield, 1933). Streptococci isolated from outbreaks of meningo-encephalitis in one to six month old pigs in Holland (Jansen and Van Dorssen, 1951) and from two to six week old piglets with meningitis and arthritis in England (Field et al, 1954) were subsequently shown by De Moor (1963) to belong to the new streptococcal groups R and S.

Streptococcus suis has subsequently been isolated from pigs in most pig rearing countries of the world including Denmark (Riising, 1976), England (Windsor and Elliot, 1975), the German Democratic Republic (Kunter and Wittig, 1976; Kunter, 1982a), Brazil (Reis et al, 1980; Farinha et al, 1981; Martins et al, 1985), Ireland (Power, 1978), the United States of America (Koehne et al, 1979), Canada (St John et al, 1982; Breton et al, 1986), Holland (Van der Schaaf et al, 1961; De Moor, 1963), West Germany (Clausen, 1980; Schoon et al, 1980), Australia (Buddle et al, 1981), Poland (Strojna et al, 1978), Rumania (Carol-Dumitriu and Bercea, 1981; Carol-Dumitriu et al, 1981b), Bulgaria (Zhelev et al, 1960), France (Vaissaire et al, 1983; Madec et al, 1985), Czechoslovakia (Nesvadba et al, 1960), Hong Kong (Chau et al, 1983), Italy (Simonella et al, 1970), Taiwan (Lu et al, 1985), China (Yang and Wang, 1985), Peru (Carpio, 1978), Japan (Azuma et al, 1983), Yugoslavia (Popovic and Dujin, 1971) and New Zealand (Robertson, 1985b).

Although S. suis consists of two main serological types (1 and 2), at least seven other serotypes (types 3 to 9) have been recognized (Perch et al, 1983; Thornton, 1987) as well as one serotype that shares properties with both S. suis types 1 and 2 and has been designated group RS (S. suis type 1/2) (Perch et al, 1981).

ECONOMIC IMPORTANCE OF STREPTOCOCCAL INFECTIONS IN PIGS

Riising et al (1976) showed that 2.4% of piglets born alive in Denmark died from a streptococcal infection during the pre-weaning period. They believed haemolytic streptococci were one of the most important bacterial causes of pre-weaning mortality. Losses from streptococcal infections made up 13.7% of the total pre-weaning deaths. However, S. suis accounted for only 2% of these streptococcal infections.

Jones (1976b) demonstrated that streptococci were commonly isolated from pigs older than one week of age. He found that 89% of pigs older than four months, were carrying streptococci within their tonsils. Pilot et al (1936) and Shimizu et al (1959) similarly demonstrated 96% and 71% of pigs were carrying streptococci within their tonsils. Because of the high rate of infection with streptococci

in tonsils and the failure to detect gross pathological changes in such tonsils, Pilot et al (1936) believed that streptococci were part of the normal bacterial flora of the lymphoid tissue of the oropharynx.

Table 2.1 lists the recorded relative proportion of streptococci belonging to each of the major Lancefield groups, isolated from diseased specimens from pigs. The recent rise in the proportion of streptococci belonging to Lancefield groups S and R may be associated with greater awareness and interest in the organisms, the availability of commercial antisera to these groups or an actual rise in the prevalence of pigs infected with these streptococci. Most isolates of Lancefield's groups S and R (S. suis types 1 and 2) have been recorded in Britain and Europe, where clinical disease due to these two groups is more commonly reported. Streptococcal meningitis accounted for 21.7% of the total post-weaning mortality in Britain in 1983 (Anon, 1983). It was also reported (Anon, 1979b) that in Britain meningitis due to S. suis type 2 together with colibacillosis, were the most commonly reported diseases in pigs. Von Bocklisch and Zepezauer (1979) recorded that streptococci belonging to groups R and S caused a more severe disease in pigs than did streptococci of other Lancefield groups.

Table 2.2 summarizes the recorded morbidity and mortality in outbreaks of S. suis types 1 and 2. Although epidemics of the disease are more likely to be reported in the literature, sporadic cases of sudden death may in fact be a more common manifestation of the disease (St. John et al, 1982).

PATHOLOGICAL EFFECTS

Clinical Signs

Streptococcus suis type 1 (group S) affects sucking piglets generally less than four weeks of age whilst S. suis type 2 (group R) affects weaner and grower pigs (Anon, 1979a). Disease due to S. suis type 2 is most common following weaning and mixing litters together, with most cases occurring between three and twelve weeks of age

TABLE 2.1

PROPORTION (%) OF DIFFERENT LANCEFIELD GROUPS* OF STREPTOCOCCI ISOLATED FROM PIGS

| REFERENCE | NUMBER OF ISOLATES EXAMINED | PERCENTAGE OF EACH LANCEFIELD GROUP ISOLATED | | | | | | |
|---------------------------------|-----------------------------|--|---------|---------|---------|---------|---------|---------|
| | | Group R | Group S | Group C | Group E | Group L | Group P | Group D |
| Simmons 1963 | 293 | 0.0 | 3.4 | 23.2 | 0.4 | 8.2 | 8.9 | 45.0 |
| Jones 1976a | 125 | 6.4 | 18.4 | 40.0 | 0.0 | 16.0 | 0.0 | 12.8 |
| Rising 1976 | 2275 | 0.2 | 1.9 | 43.9 | 1.2 | 33.7 | 2.5 | 13.8 |
| Carpio 1978 | 18** | 0.0 | 5.5 | 39.0 | 33.0 | 0.0 | 0.0 | 0.0 |
| Koehne <u>et al</u> 1979 | 98 | 14.3 | 2.0 | 42.8 | 5.1 | 4.1 | 0.0 | 30.6 |
| Von Bocklisch Zepezauer 1979 | 259 | 8.1 | 8.5 | 24.8 | 1.1 | 36.7 | 11.4 | 0.0 |

(continued)

* - Non-typable and minor groups not included

** - Isolated from healthy pigs

TABLE 2.1 (continued)

| REFERENCE | NUMBER OF ISOLATES EXAMINED | PERCENTAGE OF EACH LANCEFIELD GROUP ISOLATED | | | | | | |
|------------------------------------|-----------------------------|--|---------|---------|---------|---------|---------|---------|
| | | Group R | Group S | Group C | Group E | Group L | Group P | Group D |
| Kunter 1982a | 4554 | 8.6 | 10.3 | 26.4 | 0.0 | 16.8 | 0.0 | 0.0 |
| <u>Vaissaire et al</u> 1983 | 273 | 48.3 | 0.0 | 0.0 | 0.0 | 0.0 | 0.0 | 0.0 |
| <u>Vaissaire et al</u> 1984 | 320 | 60.0 | 0.0 | 15.0 | 10.0 | 10.0 | 0.0 | 0.0 |
| <u>Le Menec et al</u> 1985 | 200 | 64.4 | 0.0 | 0.0 | 0.0 | 0.0 | 0.0 | 0.0 |
| <u>Sugimoto et al</u> 1985 | 83 | 62.6 | 4.8 | 20.5 | 0.0 | 0.0 | 0.0 | 0.0 |
| <u>Vecht ht et al</u> 1985 | 314 | 48.4 | 0.0 | 13.7 | 0.0 | 0.0 | 0.0 | 0.0 |

TABLE 2.2

REPORTED MORBIDITY AND MORTALITY DUE TO S. SUIIS INFECTION IN PIGS

| REFERENCE | TYPE OF <u>S. SUIIS</u> | HERD MORBIDITY % | HERD MORTALITY % | CASE FATALITY RATE % | NUMBER OF PIGS ON INFECTED FARMS | NUMBER OF FARMS |
|---------------------------------|----------------------------|------------------------|------------------------|----------------------------|--|--------------------|
| <u>Zhelev et al(1960)</u> | 1 | 5.5+ | 4.7 | 85+ | 2535 | 1 |
| | | 69.5+ | 17.6 | 73+ 26.8 | 118 | 1 |
| <u>Pedersen et al(1977)</u> | 2 | 10 | 9 | 90 | 120 | 1 |
| <u>Strojna et al(1978)</u> | 1 | - | 6 | - | - | 3 |
| <u>Pedersen et al(1981)</u> | 1/2 | 10 | 9 | - | 600 | 1 |
| <u>St John et al(1982)</u> | 2 | 1-80 | 2-10 | - | - | 5 |
| <u>Azuma et al(1983)</u> | 2 | 20-30* | 0.2-3.6 | - | - | 7 |

- not recorded

+ same farm / different years

* within affected litters

(CONTINUED)

TABLE 2.2 (CONTINUED)

| REFERENCE | TYPE OF <u>S. SUIS</u> | HERD MORBIDITY % | HERD MORTALITY % | CASE FATALITY RATE % | NUMBER OF PIGS ON INFECTED FARMS | NUMBER OF FARMS |
|---------------------------------------|---------------------------|------------------------|------------------------|----------------------------|--|--------------------|
| Clifton-Hadley <u>et al</u> (1984) | 2 | 0.08-3.44 | 0-1.6 | 0-50 | 21100 | 8 |
| Vaissaire <u>et al</u> (1984) | 2 | 5-50 | 5-20 | - | - | - |
| Buddle (1985) | 2 | 2-5 | 10 | - | - | - |
| Guise <u>et al</u> (1985a) | 2 | 3.8 | 1.5 | 38 | 4650 | 1 |
| Martins <u>et al</u> (1985) | 2 | 2.6-4.5 | 2.1-2.7 | - | - | 33 |
| Lu <u>et al</u> (1985) | 1&2 | - | 5.4+ | - | 3896 | 1 |
| | | - | 3.5+ | - | 4654 | 1 |

- not recorded

+ same farm / different years

(Windsor, 1977). The clinical picture of septicaemia, meningitis and arthritis is similar with both types of infection.

The most common finding is dead pigs with few if any prior signs of disease (Buddle and Mercy, 1981; Love, 1981). Pigs with the meningitic form of disease rapidly develop serious central nervous disturbance and usually die (Pedersen et al, 1977). Nearly half of the cases reported in Canada by St John et al (1982) were reported as sudden sporadic deaths. Less acute signs may include depression, loss of appetite, skin reddening and fever. This fever is often unrecognized (Nielsen et al, 1975a; Clifton-Hadley, 1983a). These findings may be followed by nervous signs including incoordination, ataxia, circling, lateral recumbency with paddling, opisthotonus, nystagmus, tetanic spasms, convulsions and finally death (Wilkin-Sims, 1981; Buddle, 1985; Guise et al, 1985a). Azuma et al (1983) also reported dyspnoea, foaming saliva and constipation in pigs. Associated with the central nervous system disturbance, pigs may show hyperaesthesia in response to light, sound and manipulation (Pedersen et al, 1977; 1981). Septicaemia and arthritis can occur in the absence of meningitis.

Streptococcus suis has also been associated with vaginitis, abortions and stillbirths (Jones, 1976a; Sanford and Tilker, 1982), the mastitis-metritis-agalactia syndrome of sows (Sala et al, 1985), infertility (Swann and Kjar, 1980), pyelonephritis, cystitis and endometritis (Yurukov and Ganovski, 1981).

Pathology

Pigs dying as a result of infection with S. suis show a variety of non-specific pathological changes. There may be congestion of the carcass and parenchymatous organs, enlargement and congestion of lymph nodes and fibrin strands adhering to the intestinal loops (Windsor and Elliot, 1975; Power, 1978; Pedersen et al, 1981; Sharrock, 1987). The brain may appear oedematous with congestion of the meninges, however, macroscopic changes of the brain are frequently absent, with changes only detectable by histopathological techniques (Windsor, 1977; Clifton-Hadley, 1983a). An acute fibrino-purulent leptomeningitis and ependymitis can usually be demonstrated on histological sections

(Schoon et al, 1980; Schoon, 1983). This is accompanied by perivascular cuffing by neutrophils in the cortex adjacent to the meninges and ependyma. The cerebrospinal fluid is often turbid or blood stained and streptococci are frequently isolated from it (Field et al, 1954; Martins et al, 1985). In Tables 2.3 and 2.4 the pathological lesions, described by various authors, in pigs which had died from S. suis types 1 and 2 are summarized. Septicaemia was the major finding reported with S. suis type 1 whilst both meningitis and pneumonia were commonly seen in infections with S. suis type 2.

When arthritis is present, the joints are swollen with thickened red synovial membranes and excess synovial fluid (Buddle et al, 1981). Turner (1978, 1982) and Turner et al (1980) detected streptococci in 20% of joints condemned for arthritis at meatworks in South Africa.

A vegetative endocarditis of the heart valves is occasionally found. These cardiac lesions occur predominantly in older pigs and may be accompanied by septic emboli in other organs (Friend and Sims, 1978; Lamont, et al, 1984). Pedersen et al (1984) isolated S. suis from 10.3% of 107 cases of endocarditis in porcine hearts collected from slaughter houses; 3.8% of lesions were associated with S. suis types 1 or 2, 2.8% with S. suis type 1/2 (group RS - the streptococcus with characteristics of both groups R and S) and 3.7% were from non-capsulated strains of S. suis and could not be classified. Narucka and Westendorp (1973) found that streptococci were associated with 39% of 236 cases of endocarditis detected from more than 870,000 pigs slaughtered at abattoirs. Streptococci were also isolated from the spleen, kidney, liver and muscle (83%, 60%, 78% and 54% respectively) of pigs with streptococcal endocarditis. They found the ratio between left sided, right sided and bilateral endocarditis was 2:1:1 with lesions of the pulmonary valve being more common. However, Kernkamp (1941) found no predilection valve site in 19 cases of streptococcal endocarditis studied.

In North America infection with S. suis type 2 frequently involves the lungs (Schultz, 1986). Sanford and Tilker (1982) recorded the isolation of S. suis type 2 from 73% of cases of bronchopneumonia whilst Koehne et al (1979) reported 93%. Vecht et al (1986) recorded that 42% of infections with S. suis type 2 were associated with some form of pneumonia. The most frequent type of pulmonary lesions

TABLE 2.3

MAJOR PATHOLOGICAL LESIONS (%) OF PIGS ASSOCIATED WITH INFECTION BY S. SUIS TYPE 1

| REFERENCE | TOTAL NUMBER OF DISEASE CASES | SEPTICAEMIA | ARTHRITIS | MENINGITIS | PNEUMONIA |
|-------------------------------|-------------------------------------|-------------|-----------|------------|-----------|
| Wittig and Kunter 1975 | 139 | 38 | 9 | 27 | 0 |
| Jones 1976 | 23 | 52 | 22 | 17 | 0 |
| <u>Perch et al</u> 1983 | 17 | 76 | 12 | 12 | 0 |
| <u>Hommez et al</u> 1984 | 2 | 50 | 0 | 0 | 0 |
| <u>Le Menec et al</u> 1985 | 5 | 0 | 80 | 0 | 20 |

TABLE 2.4

MAJOR PATHOLOGICAL LESIONS (%) OF PIGS ASSOCIATED WITH INFECTION BY S. SUIIS TYPE 2

| REFERENCE | TOTAL NUMBER OF CASES | SEPTICAEMIA | ARTHRITIS | MENINGITIS | ENDOCARDITIS | LYMPHADENITIS | PNEUMONIA | PLEURISY | PERICARDITIS |
|-------------------------------|-----------------------------|-------------|-----------|------------|--------------|---------------|-----------|----------|--------------|
| Jones 1976a | 8 | 25 | 13 | 25 | 13 | 0 | 0 | 0 | 0 |
| St John <u>et al</u> 1982 | 20 | 0 | 0 | 15 | 10 | 15 | 40 | 50 | 20 |
| Azuma <u>et al</u> 1983 | 18 | 0 | 0 | 83 | 11 | 44 | 44 | 17 | 11 |
| Perch <u>et al</u> 1983 | 9 | 11 | 11 | 0 | 11 | 0 | 67 | 0 | 0 |
| Hommez <u>et al</u> 1984 | 27 | 7 | 15 | 22 | 4 | 0 | 63 | 0 | 0 |
| Le Menec <u>et al</u> 1985 | 56 | 55 | 4 | 16 | 2 | 0 | 23 | 0 | 0 |

recorded was a mild bronchopneumonia or fibrinous bronchopneumonia with septal haemorrhages. This form of bronchopneumonia appeared to be secondary to enzootic pneumonia due to Mycoplasma hyopneumoniae (Brown, 1969; Sanford and Tilker, 1982). Table 2.5 summarizes the proportion of S. suis type 2 isolated, either alone or with other bacteria, from cases of pneumonia recorded by four authors. Although no authors attempted to isolate mycoplasmas, Sanford and Tilker (1982) believed that most affected pigs had primary enzootic pneumonia. They also believed the mixed bacterial populations isolated from many lungs were either opportunistic or post mortem invaders. However, they considered that in those cases from which only S. suis type 2 was isolated the organism was probably the primary cause of disease. Pasteurella multocida was commonly isolated from pig lungs along with S. suis type 2. Ross (1981) and Straw (1986) found a strong association between damage of lungs by Mycoplasma hyopneumoniae and the presence of Pasteurella multocida and proposed that this organism was a common secondary invader of damaged lungs.

Other pathological findings which have been reported include swollen enlarged livers and spleen (Pedersen et al, 1977), miliary necrotic lesions of the liver and spleen (Carol-Dumitriu et al, 1981a), rhinitis (Hommeze et al, 1984), dermatitis (Carol-Dumitriu et al, 1980, 1981a), lymphadenitis (Jones, 1976a), nephritis (Azuma et al, 1983) and oto-encephalitis (Sala et al, 1985). Hommeze et al (1984) reported the concurrent isolation of Aujeszky's virus in 13% of 84 cases of infection with S. suis.

Perch et al (1983), Hommeze et al (1984) and Le Menec (1985) recorded pneumonia as the most common pathological finding in pigs with S. suis serotypes 3 to 8. Meningitis was not a common finding except in cases of infection by S. suis type 2. Thornton (1987) and Sharrock (1987) reported that S. suis type 9 produced a meningitic-septicaemic syndrome in pigs, similar to that recorded for S. suis type 2. Boetner et al (1987) recorded that S. suis type 7 was the most frequently isolated type from pigs autopsied in Denmark. They reported that S. suis type 7 was primarily associated with septicaemia in sucking piglets.

TABLE 2.5

ISOLATION OF OTHER BACTERIA FROM PNEUMONIC LUNGS
FROM WHICH S. SUIS HAD BEEN ISOLATED (%)

| BACTERIA ISOLATED | Sanford Tilker (1982) | Erickson <u>et al</u> (1984) | Koehne <u>et al</u> (1979) | St John <u>et al</u> (1982) |
|---|-----------------------------|------------------------------------|----------------------------------|-----------------------------------|
| <u>Pasteurella</u> <u>multocida</u> | 44 | 15 | 46 | 31 |
| <u>E. coli</u> | 32 | 0 | 0 | 0 |
| <u>Salmonella</u> <u>cholerae-suis</u> | 19 | 0 | 0 | 8 |
| <u>Pseudomonas</u> <u>aeruginosa</u> | 18 | 0 | 0 | 0 |
| <u>Haemophilus</u> <u>pleuropneumoniae</u> | 10 | 9 | 0 | 23 |
| B haemolytic streptococcus | 6 | 0 | 0 | 0 |
| <u>Corynebacterium</u> <u>pyogenes</u> | 6 | 0 | 0 | 0 |
| <u>Bordetella</u> <u>bronchiseptica</u> | 1 | 0 | 8 | 0 |
| <u>S. suis</u> only | 17 | 60 | 46 | 38 |
| TOTAL ISOLATES | 124 | 121 | 13 | 13 |

DIAGNOSIS

Isolation and identification of S. suis has traditionally relied on physiological, biochemical and serological tests (Clifton-Hadley and Alexander, 1983; Clifton-Hadley et al, 1985). Swabs from specimens are plated onto blood agar plates and S. suis like colonies isolated and grown in pure culture for identification by biochemical and precipitin tests. To enhance the growth of streptococci and to minimize the growth of other organisms, selective media may be used, such as Edwards media (Carter, 1973); antibiotics may be incorporated in the media (Clifton-Hadley et al, 1984b; Rosendal et al, 1986); or anti-serum to S. suis added. To enhance the isolation and detection of S. suis type 2, Clifton-Hadley et al (1984b) incorporated 0.5% to 1.0% rabbit antiserum to S. suis type 2 into their media, whilst Arends et al (1984) included 5% sheep antiserum to S. suis type 2 in their media. With such methods, S. suis type 2 colonies are characterized by the formation of a halo of precipitation around the colony which is enhanced by storage for 12 hours at 4°C (Clifton-Hadley et al, 1984b). The Analytical Profile Index (A.P.I.) 20 STREP system has been used by Tillotson (1982) and Hommez et al (1984) in conjunction with the traditional tests, to achieve a more rapid detection of cultures of S. suis type 2.

Hunt and Edwards (1982) developed a direct fluorescent antibody test (F.A.T.) against S. suis type 2 for use on pathological specimens. This test offered the advantages that the presence of the organism could be demonstrated within an hour of processing and the test was still sensitive in the presence of secondary bacterial contaminants. However Clifton-Hadley et al (1985) did not agree, as they believed this F.A.T. was not accurate because of non-specific reactions. They claimed the test lacked specificity when S. suis was present with other bacteria, although no evidence for such a belief was published. They proposed that an immunoperoxidase staining technique offered advantages over the F.A.T. in that a normal light microscope could be used and the technique could be carried out on routinely fixed and embedded tissue as well as on smears of fresh tissue.

EPIDEMIOLOGICAL ASPECTS

Transmission of Infection

Williams et al (1973) demonstrated that S. suis type 1 was carried within the palatine tonsils and the tonsils were the primary site of infection for S. suis in pigs. On histological examination of these infected tonsils no abnormalities could be detected. They proposed, based on the work of Saar and Getty (1964) and Williams and Rowland (1972), that oral infection led to establishment of S. suis type 1 in the palatine tonsil with subsequent infection of the submandibular lymph nodes by efferent lymphatic vessels. Tonsillar invasion could be detected without the development of clinical disease and it was proposed that subsequent more generalized infection was influenced by both the competitive effects of commensal flora in the tonsil and the state of immunity of the animal.

Porcine palatine tonsils are naturally inhabited by numerous streptococci including members of Lancefield's group D (Kohler and Mochmann, 1958). Although the tonsils normally act as a defence against inhaled and ingested organisms (Daleel and Frost, 1967), they can act as a portal of entry for pathogens such as Mycobacterium johnei in calves (Payne and Deans Rankin, 1961a; b) and Erysipelothrix rhusiopathiae in pigs (Timoney and Berman, 1970). Payne and Derbyshire (1963) considered that in cattle the tonsils were an important route of entry for many pathogenic bacteria.

Clifton-Hadley and Alexander (1980) also detected S. suis type 2 in the palatine tonsils of healthy pigs, however no organisms were detected in other lymphoid tissue. Williams et al (1973) using immunofluorescent techniques, frequently detected S. suis type 1 in the lumen of the tonsillar crypts, and occasionally within the epithelial and immediate subepithelial zone of the tonsil. However Arends et al (1984) demonstrated that in carriers of S. suis type 2, the organism was confined to the tonsillar crypts and could not be found in the tonsillar lymphoid tissue surrounding the crypts. These latter findings are similar to the observations of Drees and Waxler (1970) who demonstrated that when the tonsils of pigs were infected with E. coli the organism was only detected within the tonsillar crypts.

Both types of S. suis have been isolated from the tonsil and nasal chambers of apparently normal pigs (Clifton-Hadley, 1985; Schmidt, 1986). Clifton-Hadley et al (1984b) detected S. suis type 2 in only 1% of nasal samples compared with 18% of tonsillar samples.

Table 2.6 lists the recorded prevalence of carriers of S. suis type 2 detected from apparently normal pigs. These carriers were detected using cultural methods and associated confirmatory serological tests which are of low sensitivity (Hunt and Edwards, 1982; Robertson, 1985a). Streptococcus suis type 2 was not detected in the vagina or prepuce of those pigs examined. Koppang and Filseth (1958) isolated group D streptococci from the semen and prepuce of boars; whilst Jones (1966) and Maclean and Thomas (1974) demonstrated the presence of alpha haemolytic streptococci in the vagina of sows. Although these types were not classified as streptococci belonging to either groups S or R, it is possible some may have belonged to these groups as S. suis has been isolated from sows with vaginitis (Jones, 1976a; Sanford and Tilker, 1982) and with the mastitis-metritis-agalactia syndrome (Sala et al, 1985).

Clifton-Hadley et al (1984a) found that none of 89 piglets less than 19 days old were carrying S. suis type 2 in their tonsils, even when some of the piglets originated from carrier sows.

Arends et al (1984) detected more carriers when tonsils were sectioned in more than one plane before being cultured. Colonies of S. suis type 2 were normally found in small groups within the tonsil, with an average of two and a range of one to more than 50 colonies. Due to the small number of colonies present, they proposed that the percentage of carrier pigs may indeed be higher than that recorded. Clifton-Hadley and Alexander (1983) also believed that the actual tonsillar carrier rate was higher than the detectable carrier rate. In their investigation, S. suis type 2 could not be detected in tonsillar swabs taken from 20 live pigs, however 80% of these were found to be carrying the organism when a deep scrape culture technique was used at autopsy.

Clifton-Hadley and Alexander (1983) and Clifton-Hadley et al (1984a) found that the proportion of tonsillar carriers, in different groups of pigs, varied between 0 and 80%. The highest rate of

TABLE 2.6

REPORTED ISOLATION RATES OF STREPTOCOCCUS SUIS
FROM VARIOUS SITES IN PIGS

| REFERENCE | NUMBER OF HERDS EXAMINED | NUMBER OF ANIMALS EXAMINED | CLASS OF ANIMAL | SITE EXAMINED | RATE OF INFECTION (%) |
|---|--------------------------------|----------------------------------|---------------------------------------|------------------------------------|-----------------------------|
| Clausen (1980) | 15 | 364 | piglets weaners growers sows | nose tonsil cervix vagina | 0 |
| | | 52 | baconers | tonsil# | 15 |
| Clifton-Hadley and Alexander (1980) | 2 | 20 | weaners | vagina | 0 |
| | | 81 | sows gilts | vagina | 0 |
| | | 34 | working boars | prepuce | 0 |
| | | 59 | piglets 19 days | tonsil | 0 |
| | | 166 | weaners | tonsil | 3-59 |
| Clifton-Hadley and Alexander (1981) | 1 | 88 | weaners | tonsil | 10.2 |
| | 1 | 34 | weaners | tonsil | 58.8 |
| Rickert <u>et al</u> (1982) | 5* | 46 | sows | nose tonsil cervix vagina | 0 |
| | | 23 | piglets | tonsil | 0 |
| | | 140 | gilts | tonsil | 0 |
| | | 170 | porkers | tonsil# | 10 |
| | | 3+ | 190 | porkers | tonsil# |
| Clifton-Hadley and Alexander (1983) | 4* | 89 | piglets | tonsil | 0 |
| | | 386 | weaners | tonsil | 26 |
| | | 33 | growers | tonsil# | 12 |
| | | 118 | sows | tonsil | 1.7 |

(continued)

+ believed to be non-infected herds

* infected herds

tissue collected at slaughter

TABLE 2.6 (continued)

| REFERENCE | NUMBER OF HERDS EXAMINED | NUMBER OF ANIMALS EXAMINED | CLASS OF ANIMAL | SITE EXAMINED | RATE OF INFECTION (%) |
|-------------------------------------|--------------------------|----------------------------|-----------------------|---------------|-----------------------|
| <u>Arends et al</u> (1984) | - | 143 | baconers | tonsil# | 32 |
| Clifton-Hadley (1984) | 3* | 419 | 3 months to 18 months | tonsil | 8.6 |
| <u>Clifton-Hadley et al</u> (1984a) | 16 | 52+ | slaughtered pigs | tonsil# | 0 |
| | | 10 | " | " | 20 |
| | | 20+ | " | " | 25 |
| | | 10 | " | " | 80 |
| | | 68+ | " | " | 4.4 |
| | | 10 | " | " | 80 |
| | | 10 | " | " | 90 |
| | | 10 | " | " | 50 |
| | | 10 | " | " | 80 |
| | | 10 | " | " | 60 |
| | | 10 | " | " | 80 |
| | | 10 | " | " | 60 |
| | | 40+ | " | " | 0 |
| | | 15 | " | " | 73 |
| | | 40 | " | " | 42.5 |
| | | 10 | " | " | 50 |
| <u>Clifton-Hadley et al</u> (1984b) | 4 | 89 | piglets | tonsil | 0 |
| | | 386 | weaners | " | 26 |
| | | 33 | growers | " | 12 |
| | | 118 | sows | " | 1.7 |

* infected herds

tissue collected at slaughter

- number of herds sampled not recorded

infection was detected in weaned pigs between the age of four and ten weeks. This age-group has the highest incidence of clinical cases (Lamont et al, 1980). Clifton-Hadley and Alexander (1981) recorded a carrier rate of 59% in weaners housed in flat deck rooms when the disease incidence was high. This rate decreased to only 3% after rooms had been cleaned, rested, restocked and when the disease incidence was low.

Clifton-Hadley et al (1984a) recorded a variation in the tonsillar carrier rates of 0 to 100% in herds with a history of clinical disease, when samples were collected by deep tonsil scrapings post mortem. Two of four herds that had not shown previous evidence of clinical disease were found to have 25% and 4.4% carriers of S. suis type 2 respectively. They were unable to demonstrate any correlation between carrier rates and incidence of disease, herd size, age of diseased animals or with systems of husbandry.

Elliot et al (1966) demonstrated that 14 of 23 (61%) apparently normal piglets, originating from five litters which had streptococcal disease in the previous three weeks, were carrying S. suis type 1 within their throats. They believed this proportion of carriers was probably an underestimate of the real carrier rate because of the difficulty in identifying colonies of S. suis type 1 on blood agar. From these findings they postulated that the upper respiratory tract may act as a focus of infection for S. suis type 1 and that in susceptible piglets the upper respiratory tract may be the portal of entry for the organism. Bacteriological examination of the upper respiratory tract of 44 normal gilts, yielded three positive cultures (7%) of S. suis type 1. The noses of three sows from an unstated number tested were also positive.

Clifton-Hadley and Alexander (1983) identified tonsillar carriers in pigs from some weaner rooms where there had previously been no clinical cases, as well as in pigs from rooms in which clinical cases had occurred. One carrier was recorded as developing clinical meningitis 20 days after initially being detected as a tonsillar carrier. They proposed that pigs that develop clinical disease do not necessarily do so as a direct and immediate result of exposure to the organism.

The healthy inapparent carrier of S. suis appears to be the main method of spread of the disease from herd to herd. The introduction of breeding gilts from herds infected with S. suis type 2 into non-infected herds results in disease subsequently appearing in weaner and grower pigs in the previously non-infected herd. It is believed that gilts infect their own piglets, and these piglets then carry the organism into the weaning pens and infect other pigs (Clifton-Hadley and Alexander, 1981). Windsor (1977) proposed that with S. suis type 2, carrier breeding pigs infect their piglets and at the same time provide them with protective passive immunity. Subsequently after weaning, when this immunity is waning, disease due to S. suis type 2 may occur.

Clifton-Hadley et al (1984a) and Clifton-Hadley and Alexander (1984) demonstrated the presence of S. suis type 2 in herds from which clinical streptococcal meningitis had not been recorded. Bevin (1975) demonstrated the presence of opsonizing antibodies against S. suis type 2 in blood samples taken from herds believed to be free of the bacterium. However, these latter findings may have been associated with a test of low specificity or due to cross reactions with antibody elicited by other organisms. Lamont et al (1980) also reported clinical meningitis from S. suis type 2 in a herd that was completely closed with the initial breeding stock being derived by hysterectomy. Clifton-Hadley et al (1984a) proposed that pigs originating from herds free from S. suis type 2 and found to be infected at slaughter, may be contaminated by carriers during transport, lairage or after slaughter. To investigate the possibility of cross-contamination Clifton-Hadley et al (1986a) performed experiments involving the exposure of non-infected pigs to pigs with either septicaemia or clinical meningitis caused by S. suis type 2. None of the tonsils from the non-infected pigs were found to be infected with S. suis type 2 after exposure for 24 hours to the infected pigs. When nine pigs were artificially infected per os with up to 10^7 S. suis type 2, only one was found to have infected tonsils, 24 hours after infection. These researchers also demonstrated the rapid destruction of S. suis type 2 in the scald tank used for dehairing pigs. They proposed that infection of pigs with S. suis type 2 was unlikely to occur at the abattoir, provided pigs were transported directly to the abattoir and were slaughtered without being mixed or held for long periods in lairage.

Clifton-Hadley and Alexander (1981) postulated that human carriers of S. suis type 2 may exist, as several herds which had not introduced pigs were subsequently found to be infected. However, Arends et al (1984) could not isolate S. suis type 2 from tonsillar swabs of 34 men who were in frequent contact with pigs.

To explain the isolation of S. suis type 2 from pigs originating from herds that had previously shown no clinical disease, Clifton-Hadley et al (1984a) proposed that non-pathogenic variants of S. suis type 2 existed. Arends and Zanen (1985) isolated different strains of S. suis type 2 and they proposed that less pathogenic variants occurred naturally in porcine tonsils.

Clifton-Hadley and Alexander (1981) and Clifton-Hadley (1983b) demonstrated that S. suis type 2 could persist in the tonsils of healthy carrier pigs which had circulating opsonic antibodies. They also showed that pigs with opsonic antibodies against S. suis type 2 could subsequently develop clinical disease. Clifton-Hadley et al (1984b) also found that pigs with antibodies against S. suis type 2 detected by the Enzyme Linked Immunosorbent Assay (ELISA), could carry the bacterium within their tonsil. They reported that there was no apparent correlation between the ELISA assay and the ability to detect S. suis type 2 in nasal or tonsillar swabs.

The route of transmission appears to be via the upper respiratory tract (Clifton-Hadley, 1984), however it is not known if the organisms reach the meninges by the haematogenous route from the tonsil or directly through the cribriform plate of the ethmoid bone (Swe, 1976). Williams et al (1973) believed that natural infection with S. suis type 1 may be either from an aerogenous route or from ingestion.

Experiments by Clifton-Hadley et al (1984b) have shown that when carriers of S. suis type 2 are mixed with uninfected pigs, the organisms can be transmitted to the non-carrier pigs within five days. Once pigs are infected they may remain carriers for over 512 days (Clifton-Hadley and Alexander, 1984). As most bacon weight pigs are slaughtered at approximately six months of age (180 days), a pig once infected could easily be classed as a life time carrier.

Clifton-Hadley and Alexander (1983) found that when pigs were sampled over a period of 12 months the detectable carrier status of individual pigs varied. Individual pigs could alternate between positive and negative status, and it was suggested that this may be due to elimination of the organism followed by reinfection. However S. suis type 2 could not be detected for 28 days in any pigs in one pen and yet the organism was subsequently isolated from these pigs. Similarly pigs that repeatedly had negative tonsillar cultures for up to 162 days ante mortem subsequently were shown to be tonsillar carriers by deep scrape cultures post mortem. Consequently Clifton-Hadley and Alexander (1983) believed S. suis type 2 persisted at undetectable levels deep within the tonsillar tissue and only periodically multiplied to detectable levels. However S. suis type 2 was never detected in some pigs, even when they were housed with carriers pigs. These pigs, classified as non-carriers, were probably carrying the organism at undetectable levels, as Arends et al (1984) demonstrated that small numbers of S. suis type 2 were normally present within the tonsil.

Table 2.7 records the rate of isolation of S. suis type 2 from pigs originating from several herds fed antibiotics. The detection of carriers in pigs fed antibiotics, indicates that medication of a herd does not eradicate S. suis. Clifton-Hadley (1983a) believed that although antibiotic medication of feed at the periods of greatest risk decreased the incidence of clinical disease, cases sometimes occurred later when medication had ceased. Thus it was suggested that medication was only delaying the onset of clinical meningitis and not controlling the spread or multiplication of S. suis in a pig herd.

Global differences in signs of infection by S. suis

In Britain, the major clinical syndrome recorded is one of a septicaemia/meningitis with 90% of porcine bacterial meningitis being due to S. suis type 2 and the remaining 10% to S. suis type 1 (Elliot et al, 1980). In America and Canada, meningitis is rarely seen. In these countries disease with S. suis type 2 is usually associated with bronchopneumonia and polyserositis. Signs vary from mild sneezing to coughing and marked dyspnoea (St John et al, 1982; Sanford and Tilker, 1982). In France infection with S. suis type 2 produces a range of

TABLE 2.7

REPORTED ISOLATION RATES OF STREPTOCOCCUS SUIIS TYPE 2 FROM HERDS FED ANTIBIOTICS
(Clifton-Hadley and Alexander, 1984a)

| ANTIBIOTIC SUPPLEMENT | SUPPLEMENT g/TONNE FEED | PERIOD OF SUPPLEMENTATION | RATE OF INFECTION (%) |
|--------------------------|-------------------------------|---------------------------------|-----------------------------|
| Chlortetracycline | 200-400 | birth to slaughter | 80, 60, 50* |
| Chlortetracycline | 165 | 8 weeks to slaughter | 80 |
| Sulphadimidine | 165 | | |
| Procaine penicillin | 83 | | |
| Chlortetracycline | 200 | weaners | 50 |
| Chlortetracycline | 200 | 3 to 12 weeks | 73 |

* - three herds

clinical signs varying from nervous, respiratory or locomotor disorders to sudden death (Vaissaire et al, 1983). However, Madec et al (1985) could find no relationship between septicaemia with S. suis type 2 in pigs in France and respiratory lesions. In the Netherlands, Van der Schaaf et al (1961) recorded that most cases of infection with group R and S streptococci in pigs were associated with pneumonia. In New Zealand S. suis type 1 has been associated with both meningitis and polyarthrititis (Robertson, 1985b). Buddle et al (1985) reported that S. suis type 2 was one of the major causes of bacterial meningitis in Australia, however the severity of pig losses varied from state to state. It has been reported (Anon, 1986) that S. suis type 2 was the most common cause of meningitis in weaner pigs in Australia. Group S streptococci have been isolated from piglets with septicaemia and arthritis in Tasmania.

Clifton-Hadley et al (1984a) proposed that non-pathogenic strains of S. suis may exist and the varying rates of morbidity and mortality reported in different countries might be associated with differences in the prevalence of pathogenic strains rather than with differences in the overall prevalence of S. suis. Using immuno-diffusion techniques, Arends and Zanen (1985) have demonstrated at least two different strains of S. suis type 2 isolated from carrier pigs and from cases of meningitis of pigs and humans.

Power (1978) and Lamont et al (1980) recorded the spread of streptococcal meningitis across the United Kingdom, in the period from 1973 to 1978. In 1973 meningitis from infection with S. suis type 2 had not been recorded in most pig farming districts whilst by 1978 over half the districts had reported morbidity rates of greater than 5%. The increase in the number of outbreaks recorded was believed to be associated with both an increasing awareness of the disease by veterinarians and a true increase in disease prevalence.

The pattern of disease caused by S. suis type 2 is varied. Some farms have explosive outbreaks of clinical disease followed by its disappearance, on others the disease only produces sporadic losses, while on others the infection can be a source of regular and continued loss (Power, 1978; Windsor, 1980; Carrigan, 1987).

Age differences in infection with S. suis

Guise et al (1985a) recorded clinical cases of meningitis from S. suis type 2 in pigs from three to 20 weeks of age. Most cases occurred in animals between eight and 14 weeks of age. This age corresponded with the movement of pigs from the weaner house into the fattening house. They proposed that it was the "stress" imposed by subdivision of the group, moving, or the new type of accommodation which precipitated outbreaks of disease. Lamont et al (1980) recorded meningitis from S. suis type 2 in pigs less than two weeks to older than 22 weeks of age. Most cases occurred in the six to eight week old group. The outbreaks in older pigs predominantly involved farms which brought in fattening stock. St. John et al (1982) also isolated S. suis type 2 from pigs three to 24 weeks of age with most cases in the six to 12 week old group. They found no relationship between the occurrence of disease and climatic factors or to the recent movement of animals. Although Erickson et al (1984) recorded disease in sows over 12 months of age, they believed susceptibility to infection diminished with age.

Seasonal differences in infection with S. suis

Guise et al (1985a) could not demonstrate a relationship between meningitis caused by S. suis type 2 and the season of the year, although two of three small epidemics occurred in late winter and early spring. Similarly Martins et al (1985) reported outbreaks throughout the year and believed the disease was endemic in most herds. Power (1978) noted that the number of cases of meningitis caused by S. suis type 2 increased with sudden changes of weather. Sanford and Tilker (1982) and Erickson et al (1984) found an apparent clustering of cases in the colder months and believed this was due to the closer confinement of pigs at these times. However, Friend and Sims (1978), Wilkin-Sims (1981) and Buddle (1985) found a peak incidence in the warmer months in Australia. Guise et al (1986), when investigating a British pig herd for 12 months, recorded major outbreaks of disease in May and September/October, however cases were still present in all months. In their study more cases were found in the eight to nine week age group.

TREATMENT AND CONTROL OF SECONDARY CAUSAL ASSOCIATIONS

Streptococcal meningitis is frequently a rapidly fatal disease, therefore, for any treatment to be effective it must be given early (Pedersen et al, 1981; Blackburn, 1983a; Pedersen, 1983). Historically, antibiotics have been the main method of treating cases. As both types of S. suis are sensitive to a wide variety of antibiotics, a range of antibiotics including penicillin (Clifton-Hadley, 1982; Muirhead, 1987a), tylosin (Power, 1978; Schultz and Hoffmann, 1986), tetracyclines and a combination of trimethoprim and sulphadiazine (Guise et al, 1985b; 1986) have been used. Antihistamines, other antiallergic preparations and corticosteroids have also been used in conjunction with antibiotics to treat meningitis from S. suis type 2 (Windsor, 1977; Blackburn, 1983a). Holz (1950) emphasized that as well as treating the infection in streptococcal diseases of pigs, the allergic component of these diseases should not be neglected.

Douglas (1983) stated that a morbidity rate of 1% or a mortality rate of 0.5% should be considered as criteria for intervention. Above these levels group or herd preventative measures are indicated, whilst below them it is probably uneconomic to attempt any control measures other than the general care and treatment of individually affected pigs (Windsor, 1977). Heard (1984) treated clinically affected pigs by removing them to a warm dry room, administering parenteral antibiotics and by ensuring adequate fluid intake either by dosing with water (Blackburn, 1983a; Clifton-Hadley, 1983a) or by rectal infusion of an electrolyte solution (Blackburn, 1983b). As pigs suffering from meningitis show hypersensitivity to sound and light, Pedersen et al (1981) and Blackburn (1983a) believed that isolation was an important factor in treating clinical cases. Windsor (1977) considered that good nursing practices were more important than the type of antibiotic used.

When the prevalence of disease is greater than 1% herd preventative measures are indicated. These preventative measures include altering management practices, using antimicrobial therapy and vaccines (Douglas, 1983; Windsor, 1977). Wheeler (1983) classified swine meningitis as a "stress induced disease" and categorized the

stress factors as :

1. management stress produced by mixing pigs from different social groups, shifting pigs from their pens or buildings and weighing, vaccinating, tattooing, ear tagging or ear notching;
2. housing stress from overcrowding, poor ventilation and high dust and fume levels from slurry or heaters; and
3. nutritional stress due to a change in the diet following weaning.

Controlling environmental factors by minimizing overcrowding, improving shed ventilation, reducing buildup of fumes by lowering the levels of slurry and by avoiding temperature fluctuations have all been advocated to reduce the incidence of clinical disease (Cargill, 1981; Clifton-Hadley and Alexander, 1981; Clifton-Hadley, 1983a; Vaissaire *et al*, 1984). Douglas (1983) believed changes in management to avoid a continuous production system may help control the disease. He advocated replacement with an "all in - all out" housing system, as well as avoiding mixing of groups or pens of pigs. Thorough cleaning, disinfection and a period without pigs has been promoted to minimize the environmental contamination with S. suis type 1 in the farrowing accommodation (Buddle, 1985) and S. suis type 2 in the weaning pens (Clifton-Hadley, 1982; Heard, 1984). Buddle (1981) believed the application of an umbilical antiseptic to all piglets and a reduction in the abrasive nature of piggery floors could help reduce polyarthrititis caused by S. suis type 1. Heard (1984) suggested that if the average age of the breeding stock was high, herd immunity would be maximized. He believed that gilts should be gradually introduced to a herd, to prevent the sudden presence of large numbers of susceptible non-exposed animals.

Wheeler (1983) and Muirhead (1987b) believed that nutritional factors such as Vitamin E could be important in helping to limit clinical disease from S. suis type 2. Zhelev *et al* (1960) claimed to have achieved good results in treating piglets with meningo-encephalitis, by using vitamin D and calcium gluconate in conjunction with chlortetracycline.

The most frequent method used by pig farmers in Great Britain to control meningitis from S. suis type 2, has been the incorporation of

strategic medication at periods of greatest risks (Clifton-Hadley and Alexander, 1981; Clifton-Hadley, 1983a). In-feed medication is frequently used during the period of peak incidence and is more popular than water medication (Douglas, 1983). Traditionally penicillin has been the antibiotic of choice to add to the feed (Clifton-Hadley, 1983a).

Ripley (1983) performed a cost-benefit analysis on a herd with meningitis from S. suis type 2. He believed it is economic to supplement feed with penicillin only when the prevalence of disease is more than 2% and when one third of these pigs are dying. When more expensive antibiotics are added to the feed, the prevalence must be greater than 5% with a 33% mortality rate or 3% with a 75% mortality rate for the antibiotic supplementation to be economical.

Douglas (1984) showed that medication of feed with chlortetracycline, penicillin and sulphadimidine at 167, 83 and 167 parts per million respectively, significantly reduced the incidence of meningitis from S. suis type 2. However, the initial incidence of streptococcal meningitis was low, as was the case mortality rate, and no indication of the economic assessment of this medication regime was given. Guise et al (1985b) found that both a trimethoprim-sulphadiazine preparation and a procaine penicillin G product significantly reduced the mortality rate of pigs affected with meningitis from S. suis type 2 compared with a vitamin B and C complex. However Guise et al (1986) found no differences in the incidence of streptococcal meningitis during the growing/fattening periods, between one group of pigs that received prophylactic levels of a trimethoprim-sulphadiazine combination in the feed and another unmedicated group from the same herd.

Buddle (1985) and Windsor and Elliot (1975) proposed in-feed medication with tetracyclines to control streptococcal meningitis during the period of risk. However Windsor (1977) reported some antibiotic resistance to tetracyclines and Wheeler (1983) recorded that most isolates from southern England were resistant to this antibiotic. To control meningitis from S. suis type 2 in Australia, Seaman and Armstrong (1979) suggested early treatment of clinical cases with parenteral penicillin and in-feed supplementation of sows with tylosin and sulphadimidine.

Vaccination

Control of human meningococcal meningitis and pneumonia caused by S. pneumoniae has been achieved by vaccination with type specific polysaccharide (Gotschlich et al, 1978; Austrian, 1984). As S. suis type 2 is of one immunological type (belonging to Lancefield's group R), Elliot et al (1980) proposed that the disease might be controlled by vaccination with a component of the organism similar to the control used with human meningococcal meningitis. By using a bactericidal test they showed that of 17 pigs injected with the capsular polysaccharide of S. suis type 2 and Freund's incomplete adjuvant, 16 pigs elicited an opsonizing antibody response. This compared with only two of 14 when the capsular polysaccharide was injected alone and only two of 21 non-immunized controls.

Ripley et al (1980) prepared autogenous vaccines of S. suis type 2 and evaluated their effects on nine farms. The vaccines were prepared from cultures of organisms killed by formalin, with alhydrogel added as an adjuvant. Initially breeding stock were vaccinated six and two weeks prior to farrowing and subsequently two weeks before further farrowings. On four farms adequate control of disease was evident in vaccinated pigs compared with control pigs from these farms. On the remaining five farms vaccination did not adequately control disease. The mortality rate of pigs on three farms was not reduced, the mortality rate on another farm was reduced but not to an acceptable level and there was a very low incidence of meningitis in all pigs on the fifth pig herd. On one farm the vaccination program increased the mean age at which pigs became affected, indicating that only temporary protection was provided. The autogenous vaccine appeared to be more successful on farms in certain areas and it was proposed that strain differences may occur or that factors such as the rate of introduction of infected animals, stocking densities and house ventilation may affect the challenge offered to a vaccine.

Ripley (1983) vaccinated both sows and piglets with a formalin killed vaccine of S. suis type 2 using an alhydrogel adjuvant. The results showed that vaccination of piglets did not appear to be of benefit, especially if their dam was vaccinated. It was proposed that the vaccine's poor performance in piglets was caused by interference

from passively acquired maternal immunity. Enzyme Linked Immunosorbent Assays performed on the sera from piglets and sows showed that an antibody response to the vaccine was depressed when there was pre-existing antibody, either actively or passively derived. When different compounds were used as adjuvants, the oil adjuvant produced a significant rise in antibody level compared with a transient rise when alhydrogel was used. However, vaccines using oil as an adjuvant had the disadvantage that they produced a local reaction at the site of injection, which could persist for several months. Further injections of antigen did not, however, boost this antibody response. Vaccination of sows induced higher antibody titres in both the serum and colostrum when compared with non-vaccinated sows. The piglets from the vaccinated sows showed a 50% reduction in the prevalence of clinical meningitis from S. suis type 2. They believed that vaccination helped prevent the dissemination of S. suis type 2 after it had reached the blood stream. It was proposed that meningitis due to S. suis type 2 was a difficult disease to control by vaccination, as the disease occurred when maternally derived antibody was declining and the immune response by the susceptible piglet was limited.

Agarwal et al (1969) demonstrated that serum from adult pigs was bacteriostatic for S. suis type 1. When sow serum was added to the blood of susceptible piglets, it conferred bacteriostatic activity against S. suis type 1 in vitro and passively protected such piglets against experimental infection with S. suis type 1 in vivo. Streptococcus suis type 1 could not multiply in the blood of 58% of 160 conventionally reared piglets. The blood from all these piglets became bacteriostatic for S. suis type 1 when the animals reached the age of six to eight weeks. The blood from animals raised in a "pathogen free" environment was not bacteriostatic for S. suis type 1. Based on these results the authors believed that infection with S. suis type 1 could be controlled by a vaccination program.

Wittig and Kunter (1975) and Scholl et al (1976) recorded good results in controlling disease from S. suis type 1 with the use of autogenous vaccines. Ripley (1983) found that the prevalence of disease caused by S. suis type 1 and the severity of the disease, based on the mortality rate and number of treatment days required per pig, were significantly reduced in the progeny of sows vaccinated with an autogenous S. suis type 1 vaccine. It was proposed that the vaccine

prevented the dissemination of the organism after it had entered the blood stream.

Senf et al (1980) recorded a significant reduction in the incidence of arthritis in piglets following the vaccination of sows, five and two weeks prior to parturition with a streptococcal vaccine containing members of Lancefield groups C, L and S. The prevalence of arthritis in eight herds ranged from 4.8% to 20.8% prior to vaccination. This was reduced to 1.6% and 11.1% following the vaccination program. They reported no control of arthritis when only the hygiene of the piggery was improved. Scholl et al (1983) also prepared a vaccine containing the three streptococcal groups C, L and S, as well as Staphylococcus aureus. Vaccination appeared to have little influence on the incidence of arthritis, however there was a drop in the recorded frequency of puerperal disorders. A polyvalent vaccine against paratyphoid, Pasteurella and a diplococcus (presumably S. suis type 1) was prepared by Malyavin (1956) and inoculated three times into piglets. The mortality rate for a four month period was reduced from 7.1% in nearly 14,000 unvaccinated controls to 1.1% in 20,000 vaccinated piglets, however the individual reduction in streptococcal septicaemia was not recorded.

Bercea et al (1981) vaccinated sows five and three weeks before farrowing with an inactivated vaccine containing equal parts of bacterial cells of S. suis types 1 and 2. The incidence of streptococcosis in piglets was reduced from 12.1% to 0.6% following a one year vaccination program however there were no piglets used as controls during this period.

Eradication

Initial attempts to eradicate S. suis type 2 were made by using complete herd antibiotic medication (Windsor, 1977; Clifton-Hadley, 1983a). Although this temporarily decreased the incidence of disease, it was not successful in eradicating S. suis type 2 from herds. Clifton-Hadley and Alexander (1980) found the bacterium could persist in the tonsils of pigs receiving feed medicated with penicillin. Depopulation and restocking with non-carrier animals has been suggested as a possible means of eradication, however this is not

usually economically feasible (Windsor, 1977). Due to the low sensitivity of the tests traditionally used to detect S. suis type 2 (Robertson, 1985a), it is difficult to certify a herd free from this organism (Clifton-Hadley, 1983a). Hysterectomy or hysterotomy derived pigs have been suggested as a possible method to start a herd free from S. suis type 2 (Foster, 1984). Medicated early weaning has also been advocated to eradicate S. suis type 2 from the pig herd (Alexander *et al*, 1980). This involves treating sows both before and after farrowing with either tiamulin or a trimethoprim-sulphonamide preparation, and the weaning of piglets at five days of age into an isolated weaning unit. Love (1981) believed that S. suis type 2 could be eradicated from a herd by giving a single injection of long-acting penicillin to all stock on the farm or by giving long-acting penicillin to all breeding stock followed by treatment of the individual sows as they entered the farrowing shed. However these methods are yet to be substantiated (Clifton-Hadley and Alexander, 1981).

SUMMARY OF EPIDEMIOLOGICAL FEATURES

This literature review on the infection of pigs with S. suis types 1 and 2, has revealed some conflicting reports and hypotheses. Although the epidemiological pattern appears unclear, some definite factors appear to emerge.

1. Infection of pigs with S. suis has been detected in all countries where investigations have been carried out.
2. Although the reported prevalence of infection has been variable, most countries have reported greater than 10% of pigs infected and often considerably more.
3. Most infections are subclinical with the organism being carried in the normal palatine tonsils of pigs.
4. Carriers play an important role in the spread of infection to other pigs and herds.

5. Streptococcus suis can rapidly spread to non-infected pigs within five days of mixing with carriers.
6. Once palatine tonsils are infected they can remain so for over 18 months.
7. Although the carrier state of individual pigs may appear to fluctuate between positive and negative, infection is still permanently maintained within a herd.
8. Streptococcus suis can survive in the tonsil even when antibiotics are administered or when circulating antibodies are present.
9. When clinical disease occurs, S. suis type 1 predominantly affects sucking piglets and S. suis type 2 weaners and growers.
10. Although the common clinical syndrome is one of meningitis, arthritis and septicaemia, the syndrome varies from country to country.
11. Streptococcus suis can be detected in pigs from herds which have had no reported outbreaks of clinical disease due to S. suis.
12. The economic importance and clinical effects of infection appear to have been increasing over the last decade.
13. There is no obvious seasonal pattern of disease.
14. It would appear that different strains of S. suis exist which have differing degrees of pathogenicity for pigs.
15. Treatment has relied traditionally on antibiotics, good nursing and changes in management of the piggery.
16. Vaccination as a means of controlling disease has been of equivocal value.
17. It would appear to be difficult if not impossible to eradicate S. suis from a herd of pigs.

CHAPTER III

DEVELOPMENT OF MICROBIOLOGICAL AND SEROLOGICAL TECHNIQUES

This chapter describes the "traditional" microbiological techniques used for the initial identification of S. suis in pigs from New Zealand; the subsequent development of the Indirect Fluorescent Antibody Test (I.F.A.T.), a test designed to investigate the epidemiology of infection with S. suis; and the development of an Enzyme Linked Immunosorbent Assay (ELISA) to study the pattern of antibodies to S. suis in pigs and humans.

A. TRADITIONAL MICROBIOLOGICAL TECHNIQUES

INTRODUCTION

Streptococci belong to the family Streptococcaceae, genus Streptococcus. They are Gram positive coccoid bacteria that are non-motile and both catalase and oxidase negative (Buxton and Fraser, 1977; Facklam, 1980). Organisms belonging to this genus are characterized by their capacity to produce chains of varying lengths of cocci especially in a liquid medium. Streptococci can be aerobic, anaerobic, facultative anaerobic or microaerophilic (Cowan and Steel, 1974; Facklam, 1980).

Streptococci are identified by their haemolytic action on blood agar, physiological and biochemical reactions and their antigenic properties. The most frequently used serological technique for the classification of streptococci is that proposed by Lancefield (1933, 1938) which identifies specific polysaccharide antigens (haptenes) present in many streptococci. This is the main taxonomic criterion for S. suis.

The streptococcal groups S and R initially proposed by De Moor (1963), could be recognized by their characteristic haemolytic, physiological and antigenic properties. De Moor (1962a, b) initially

proposed the species name S. subacidus for the strains isolated from pigs, which included those that were biochemically similar to, yet serologically different from, groups R and S. The name Streptococcus suis type 1 was later proposed for streptococci belonging to Lancefield's group S (Elliot, 1966) and Streptococcus suis type 2 for group R streptococci (Windsor and Elliot, 1975). Vecht et al (1985) stated that the biochemical profiles of S. suis type 2 and S. subacidus type 2 were almost identical and proposed the name S. suis for all strains with the "characteristic profile". The name S. suis has also been used to identify group E streptococci of pigs (Collier and Noel, 1971a; 1971b; 1974). However, it is now accepted that the name S. suis should only be applied to streptococci of Lancefield groups R and S, although the species name has not been formally proposed (Hardie, 1986).

There are numerous factors influencing the haemolytic properties of streptococci including the type of media, type of blood used in the media, duration of incubation, concentration of atmospheric gases and the position of colonies in the media (Carter, 1973). The haemolytic pattern of groups R and S streptococci has varied from non-haemolytic, alpha haemolytic to beta haemolytic (Windsor and Elliot, 1975; Jones, 1976a; Friend and Sims, 1978; Koehne et al, 1979). Clifton-Hadley et al (1984b) also recorded the variable haemolytic pattern of streptococci isolated from pigs and the difficulty in detecting "characteristic" S. suis on blood agar.

In biochemical tests, the characteristic difference between S. suis type 1 (group S) and S. suis type 2 (group R) streptococci is in their fermentation of raffinose. Group R streptococci ferment raffinose whilst group S do not (Perch et al, 1981). Table 3.1 records the reactions of S. suis types 1 and 2 for numerous biochemical tests. Ross (1981) classified organisms of S. suis type 2 as fermenting both inulin and raffinose. However because of the variable fermentation response shown in Table 3.1, it is possible that variants of S. suis may be missed by using such a rigid screening process. As all strains of S. suis fail to grow in 6.5% NaCl broth, Hommez et al (1986) proposed that this test be used in the initial screening procedure.

Elliot (1966) demonstrated that S. suis constitutes a subgroup of Lancefield's group D streptococci as it contained the intracellular

TABLE 3.1

BIOCHEMICAL AND PHYSIOLOGICAL CHARACTERISTICS
OF STREPTOCOCCUS SUIS TYPES 1 AND 2

| TEST | S. SUIS TYPE 1 % POSITIVE | S. SUIS TYPE 2 % POSITIVE |
|---------------------------|------------------------------|------------------------------|
| V.P. | 0 ^{abc} | 0 ^{abc} |
| HIPPURATE | 0 ^{abd} | 0 ^{abd} |
| AESCULIN HYDROLYSIS | 100 ^{c99b80a} | 100 ^{c90a71b53g} |
| ARGININE HYDROLYSIS | 100 ^{ac99b} | 100 ^{ac99b71f} |
| RIBOSE FERMENTATION | 0 ^{abc} | 0 ^{abc} |
| ARABINOSE " | 0 ^{abcd} | 0 ^{abcd} |
| MANNITOL " | 0 ^{abcd} | 0 ^{abcd} |
| SORBITOL " | 0 ^{abcd} | 0 ^{abcdg} |
| LACTOSE " | 100 ^{acd98b} | 100 ^{abcd98g} |
| TREHALOSE " | 100 ^{acd99b} | 100 ^{acd99b94e93g} |
| INULIN " | 100 ^{acd98b} | 100 ^{cd85be73f19a} |
| RAFFINOSE " | 0 ^{ab4d} | 100 ^{abc97d78g72e} |
| GLYCOGEN " | 100 ^{abcd} | 100 ^{abcd} |
| GROWTH IN 6.5% NaCl BROTH | 0 ^{bd} | 0 ^{bd} |
| GROWTH AT 45°C | 0 ^d | 0 ^d |

- a - Colman and Ball (1984)
b - Anon. (1982a)
c - Bridge and Sneath (1983)
d - Perch et al (1981)
e - Le Menec et al (1985)
f - Hommez et al (1986)
g - Erickson et al (1984)

teichoic acid common to all members of group D (Elliot, 1960; 1983). Elliot and Tai (1978) showed that the immunological component characteristic for S. suis was within the capsule. This site differs from most other streptococci where the immunological agent is present within the cell wall. The capsular polysaccharide of both S. suis types 1 and 2 contain the sugars glucose, galactose, N-acetyl glucosamine and sialic acid (Elliot, 1983; Elliot et al, 1980). These substances are also found in the type specific polysaccharide of group B streptococci which are responsible for human neonatal meningitis (Baker et al, 1976; Tai et al, 1979). Meningitis due to Group B streptococci is similar to that caused by S. suis in that specific types of both organisms affect certain age groups (Elliot et al, 1966; Windsor and Elliot, 1975).

The capsular polysaccharide of S. suis is readily distinguishable from typical streptococcal cell wall carbohydrates by virtue of its high molecular weight and lability in hot acid (Elliot and Tai, 1978). Hot acid extraction of the capsular antigen of S. suis type 2 is only possible when the concentration of hydrochloric acid (HCl) is reduced from 0.2 N to 0.066 N (Perch et al, 1983). However S. suis type 1, like most other streptococci, can be grouped by using extracts prepared with 0.2 N HCl as described later in this chapter.

Although S. suis consists of two main serological types, 1 and 2 (Lancefield groups S and R), at least another seven serotypes (types 3 to 9) have been recognized (Perch et al, 1983; Boetner et al, 1987; Thornton, 1987). Serotypes 3 to 8 are similar in their biochemical reactions to S. suis types 1 and 2, except for some variable results with hippurate hydrolysis and inulin fermentation (Perch et al, 1983). In Belgium, Hommez et al (1984, 1986) identified S. suis types 1 to 8, as well as numerous other strains that could not be typed, from pigs with a range of pathological lesions.

The type antigen of types 2, 7 and 8, in contrast to that of the other types, are destroyed by extraction with 0.2 N HCl but not with 0.066 N HCl (Perch et al, 1983). De Moor (1963) similarly demonstrated the heat lability of the antigen of S. suis type 2 and the difficulty in producing an extract for Lancefield grouping.

The following section describes the isolation and identification

of S. suis from pigs in New Zealand. Traditional microbiological techniques including cultural, biochemical and serological tests were initially used to determine if S. suis was present in this country.

MATERIALS AND METHODS

Cultural Techniques

To culture tissues for S. suis, the surface of the samples was initially sterilized in the flame of a bunsen burner. The sample was then incised with a sterile scalpel. Swabs were taken from the incised surface and plated onto Columbia Base Agar¹ incorporating 5% sheep blood. Agar plates were incubated at 37°C for 18 hours and colonies of alpha haemolytic streptococci were selected and subcultured to obtain a pure growth of organisms. A Jensen's modified Gram stain (Cruickshank et al, 1975), utilizing acetone as the decolourizing agent, was performed on a smear from the pure growth to ensure that a Gram positive cocci had been isolated. Presumptive streptococcal colonies were then selected for biochemical testing. Samples were also plated onto Edward's Medium (modified)² and handled in a similar manner to those on sheep blood agar.

Strains of S. suis used

Type cultures of both S. suis types 1 and 2 (N.C.T.C 10234 and N.C.T.C 10237) were received from the National Health Institute, Wellington, New Zealand and one isolate of S. suis type 2 (F27001) was provided by Auckland Hospital from a blood culture taken from a patient with bacteraemia. All other cultures were isolated from samples collected from live pigs, pigs at autopsy or from pigs slaughtered at a meatworks.

Colonial Growth and Morphology

Pure cultures of both S. suis types 1 and 2 were grown on Columbia Base Agar incorporating 5% sheep blood under aerobic

¹ GIBCO laboratories, Madison, Wisconsin, U.S.A.

² Oxoid Limited, Basingstoke, Hampshire, England

conditions, anaerobic conditions utilizing a BBL Gas Pak³ and in an incubator with an increased carbon dioxide concentration of 8%. The growth, morphology and zones of haemolysis were recorded and compared after 18 hours of incubation at 37°C.

Biochemical Tests

Approximately six streptococcal colonies from each pure culture were inoculated into a bijou bottle containing three ml of brain heart infusion broth⁴. The broth was incubated for four to six hours to produce a turbid growth of streptococci. Four drops of the broth were initially inoculated into each of the following carbohydrate solutions - arabinose, mannitol, sorbitol, ribose, trehalose, raffinose, inulin, glycogen, and salicin (Appendix I) and also into aesculin agar, methyl red/Voges-Proskauer (M.R./V.P.) solution, methylene blue milk and litmus milk. The same volume of broth was infused into arginine agar and a layer of molten paraffin wax deposited over this media. All samples were incubated at 37°C for up to three days and the results recorded using the diagnostic criteria described by MacFaddin (1980). A shorter biochemical profile, which involved testing the streptococcus in ribose, mannitol, raffinose and inulin, was later used to speed up the identification of S. suis like organisms.

Lancefield Extract

Streptococci that were biochemically typical of either S. suis types 1 or 2 were selected for grouping by the Lancefield precipitin test (Lancefield, 1943; Swift et al., 1943). The streptococci were inoculated into 50 ml of Todd Hewitt Broth⁵ and incubated at 37°C for 18 to 24 hours. A sample of the broth was Gram stained and subcultured onto sheep blood agar to check the purity of the growth. The broth was centrifuged for 30 minutes at 2,000 rpm to pack the cells and the supernatant discarded. One drop of 0.04% meta cresol purple

³ BBL Microbiology Systems, Becton Dickinson and Co.,
Cockeysville M.D. 21030

⁴ Difco Laboratories, Detroit, Michigan, U.S.A.

⁵ GIBCO Diagnostics, Madison, Wisconsin, U.S.A.

(Appendix I) was added to the centrifuged sediment. Because of the susceptibility of the capsular polysaccharide of S. suis type 2 to extreme heat and acidic conditions (Perch et al, 1983), 0.3 ml of 0.05 N HCl diluted in 0.85% NaCl was added to the sediment. For streptococci with biochemical profiles similar to S. suis type 1, 0.3 ml of 0.2 N HCl was added to the sediment. The solution was mixed well, transferred to a clean test tube and placed in a boiling water bath for ten minutes. The tube was agitated several times during the extraction process. After heat treatment the solution was centrifuged for a further 30 minutes at 2,000 rpm and the supernatant transferred to another clean test tube with the residue being discarded. The extract was neutralized by the addition of 0.2 N NaOH (diluted in distilled water). This was added drop by drop until the extract turned to a faint purple colour (indicating a pH of 7.4 to 7.8). The extract was centrifuged for a further 30 minutes at 2,000 rpm and the supernatant fluid transferred to another test tube for use in the precipitin test.

Precipitin Test

Commercial group D, S and R streptococcal⁶ antiserum was used for grouping the streptococcal extracts. A clean capillary tube⁷ was dipped into the grouping serum to draw up a column of anti-serum approximately one cm long. The capillary tube was carefully wiped with a tissue and dipped into the streptococcal extract to draw up a volume approximately equal to that of the antiserum in the tube. The end of the capillary tube was imbedded into plasticine, and the tube inverted and placed in a vertical position. Capillary tubes were examined under bright light against a dark background for up to 30 minutes after preparation. A positive reaction was detected by the formation of a precipitate at the interface between the serum and extract (Lancefield, 1938).

⁶ Wellcome Reagents Limited, Beckenham, England

⁷ Terumo Capillary Tubes, Terumo Corporation, Tokyo, Japan

Samples

Palatine tonsils were collected from apparently healthy pigs slaughtered at a meatworks. These tonsils were returned to the laboratory within two hours of collection and processed as described earlier. Similarly, samples were collected from pigs that were autopsied at the Department of Veterinary Pathology and Public Health, Massey University.

Antibiotic Sensitivity Tests

Antibiotic sensitivity tests were performed on Iso-sensitest⁸ agar using antibiotic impregnated discs as described by Garrod et al (1971). Staphylococcus aureus (N.C.T.C. 6571 - Oxford Staphylococcus) was used as a control organism and was sensitive to all antibiotics tested. A field isolate of both S. suis types 1 and 2 and type cultures (N.C.T.C. 10234 and N.C.T.C. 10237) were used in these sensitivity tests. A strain of S. suis type 2, isolated from a human patient with bacteraemia was also included in the tests.

Colonies of S. suis were inoculated into brain heart infusion broth and incubated for several hours to produce a dense confluent growth. A sterile swab was immersed in the broth and applied as a band across the centre of the culture plate with the control organism being applied to either side of the agar plate, as illustrated in Figure 3.1. A needle was used to press four different antibiotic discs firmly in place on the agar at the junction between the cultures of St. aureus and S. suis. Plates were incubated for 24 to 48 hours at 37°C. The organism was classified as sensitive to the antibiotic when the radius of inhibition of growth for S. suis was equal to, wider than, or not more than three mm smaller than the control St. aureus as shown in (a) Figure 3.2. Streptococcus suis was classed as resistant to the antibiotic if the radius of zone of inhibition was less than three mm as seen in (c) in Figure 3.2. The organism was classified as having intermediate sensitivity when the radius of the zone of inhibition for S. suis was greater than three mm but smaller than the radius of the control organism by more than three mm (b in Figure 3.2).

⁸ Oxoid Limited, Basingstoke, Hampshire, England

FIGURE 3.1

POSITION OF ORGANISMS AND ANTIBIOTIC DISCS
FOR SENSITIVITY TESTS

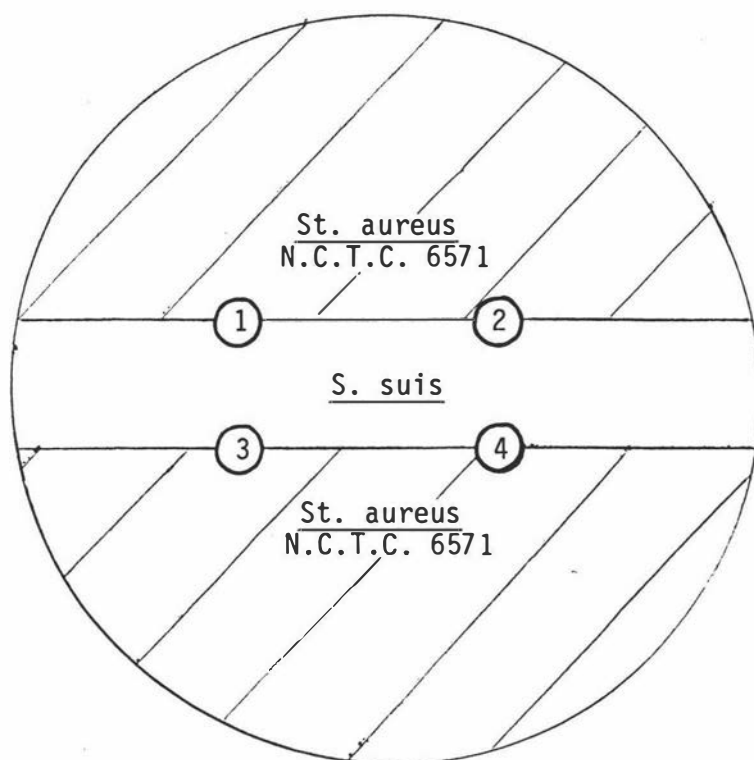

1-4 antibiotic discs

FIGURE 3.2

ANTIBIOTIC SENSITIVITY OF S. SUIS

(a) Sensitive

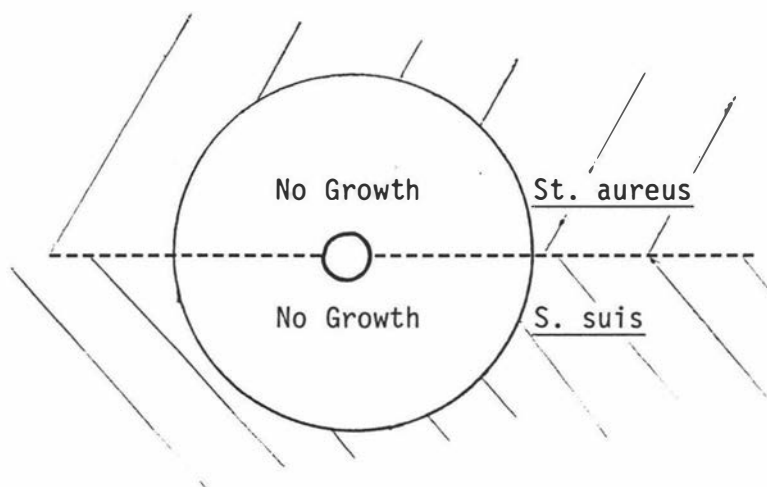

(b) Intermediate

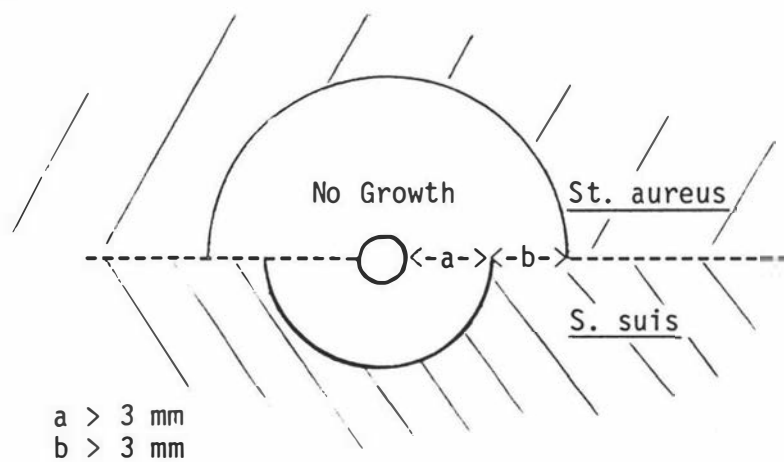

(c) Resistant

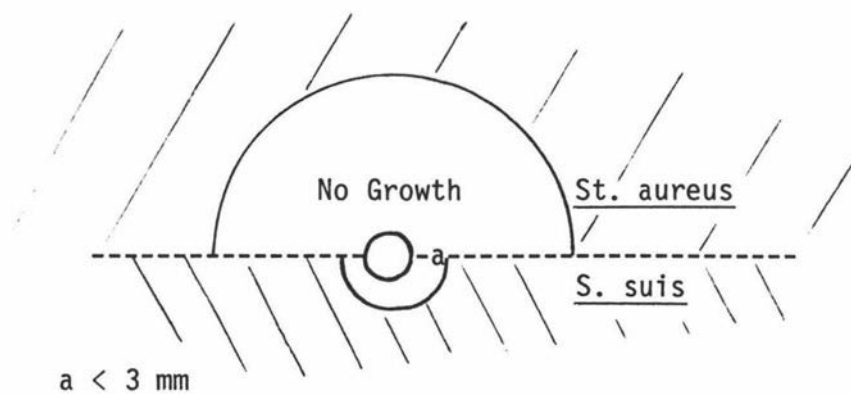

RESULTS

Morphological Features

The type cultures of S. suis types 1 and 2 were alpha haemolytic when grown aerobically on sheep blood agar. Small mucoid semi-translucent colonies, with a diameter of approximately one mm, were formed after 24 hours incubation. All isolates of S. suis showed this same form of haemolysis on this medium (Plate 3.1). The zone of haemolysis enlarged and became similar to a beta zone of haemolysis after three days of incubation. Colonies were largest (up to two mm diameter) and had the largest zone of haemolysis when grown in an atmosphere with an increased carbon dioxide concentration. Colonies were the smallest and slowest growing when incubated aerobically.

After 18 hours of incubation at 37°C a turbid growth was visible in Todd Hewitt Broth without the formation of a sediment. Short chains (three and four cocci) were observed when this broth was Gram stained (Plate 3.2).

On Edwards Medium there was darkening of the agar around the colonies of S. suis types 1 and 2.

Biochemical Reactions

The biochemical reactions for all isolates of S. suis are shown in Table 3.2.

The type cultures and all other isolates of S. suis produced acid and clots in litmus milk, reduced methylene blue but did not react to the Voges-Proskauer test.

All extracts of S. suis type 1 made with 0.2 N HCl were precipitated with group S streptococcal antiserum. With this concentration of acid, only 5% of the extracts from isolates of S. suis type 2 reacted with group R antiserum. When the extract was made with 0.05 N HCl all isolates of S. suis type 2 precipitated group R antiserum. No extracts from isolates of either S. suis types 1 or 2 precipitated group D antiserum.

PLATE 3.1

THE HAEMOLYSIS OF S. SUIS TYPE 2 ON SHEEP BLOOD AGAR

PLATE 3.2

A GRAM STAIN OF S. SUIS TYPE 2

TABLE 3.2

THE BIOCHEMICAL AND GROWTH CHARACTERISTICS OF
STREPTOCOCCUS SUIS TYPES 1 AND 2

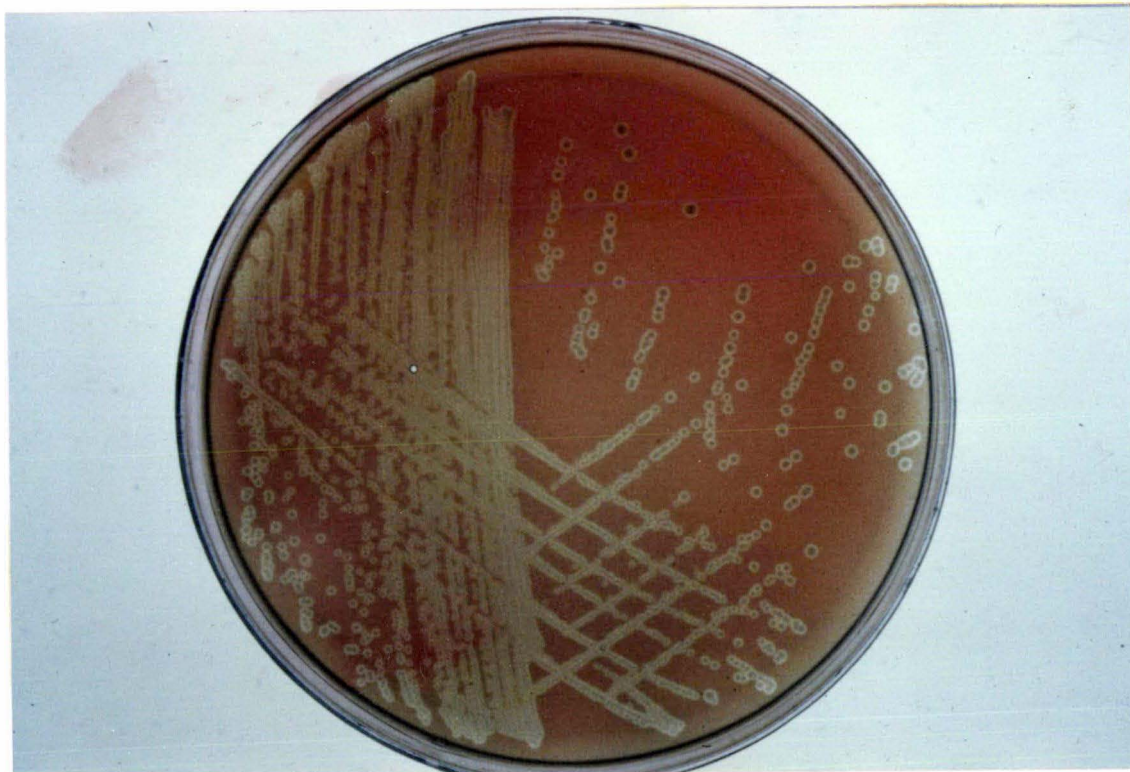
| TEST | <u>S. SUIS</u> TYPE 1a* | <u>S. SUIS</u> TYPE 2b* |
|---------------------------|-------------------------|-------------------------|
| V.P. | 0 | 0 |
| Aesculin Hydrolysis | 100 | 100 |
| Arginine Hydrolysis | 100 | 100 |
| Ribose Fermentation | 0 | 0 |
| Arabinose " | 0 | 0 |
| Mannitol " | 0 | 0 |
| Sorbitol " | 0 | 0 |
| Lactose " | 100 | 100 |
| Trehalose " | 100 | 100 |
| Salicin " | 100 | 100 |
| Inulin " | 100 | 100 |
| Raffinose " | 0 | 100 |
| Glycogen " | 100 | 100 |
| Growth in 6.5% NaCl Broth | 0 | 0 |
| Growth at 45°C | 0 | 0 |

* percentage of positive isolates

a - 36 strains tested

b - 45 strains tested

Of 36 streptococci with similar biochemical profiles to S. suis type 1 (as listed in Table 3.2), only 20 (55%) produced a positive precipitin test with group S streptococcal antiserum. Similarly only 40 of 145 (27%) extracts from streptococci with a biochemical profile characteristic of S. suis type 2, reacted with group R streptococcal antiserum. When traditional microbiological techniques were used for culturing palatine tonsils collected at the meatworks, S. suis type 1 was isolated from 12% and S. suis type 2 from 19% of the tonsils.

The extract from one isolate of S. suis type 2 lost the ability to react with group R antiserum after the organism had been cultured and subcultured on sheep blood agar for more than ten times. This loss of serological reactivity was accompanied by the presence of a sediment after overnight incubation in Todd Hewitt Broth. No other isolate of either S. suis type 1 or 2 demonstrated a similar loss of serological reactivity. In retrospect, it is unfortunate that this isolate was not examined for the presence of a capsule.

Antibiotic Sensitivity

The sensitivity patterns obtained from the two type cultures, the human isolate of S. suis type 2 and two field isolates are recorded in Table 3.3. All isolates were sensitive to penicillin. Field strains were susceptible to the antibiotics routinely used in piggeries such as penicillin, tetracycline, ampicillin, erythromycin and trimethoprim.

DISCUSSION

Elliot (1966) and Elliot and Tai (1978) classified both S. suis types 1 and 2 as subgroups of the group D streptococci. However, in this investigation no positive reactions were seen between the Lancefield extracts of the isolates of S. suis and group D antiserum. These findings were similar to those of Jones (1976a) and Hommez et al (1986) who found no reaction between group D antiserum and Lancefield extracts prepared from over 200 isolates of S. suis. Medrek and Barnes (1962) demonstrated that some group D streptococci, when grown under certain conditions, yielded Lancefield extracts that would not react with group D antiserum. However, when such streptococci were grown in

TABLE 3.3

SENSITIVITY OF S. SUIS TO ANTIBIOTICS

| ANTIBIOTIC | <u>S. SUIS</u> TYPE 2 | | | <u>S. SUIS</u> TYPE 1 | |
|-----------------|-----------------------|---------------|---------------|-----------------------|---------------|
| | Type Culture | Field Isolate | Human Isolate | Type Culture | Field Isolate |
| Ampicillin | S | S | S | S | S |
| Carbenicillin | S | S | S | S | S |
| Cephalothin | S | S | I | I | I |
| Chloramphenicol | S | S | I | S | S |
| Erythromycin | S | S | S | S | S |
| Furadantin | S | S | I | S | S |
| Fusidic Acid | I | I | I | R | R |
| Gentamicin | I | I | I | I | I |
| Kanamycin | I | S | I | I | I |
| Lincomycin | I | I | I | S | S |
| Methicillin | S | S | I | S | S |
| Nalidixic Acid | I | I | I | R | S |
| Neomycin | I | I | R | I | I |
| Penicillin | S | S | S | S | S |
| Streptomycin | S | S | I | S | R |
| Sulphafurazole | I | I | R | R | R |
| Tetracycline | I | S | I | S | S |
| Trimethoprim | S | S | I | S | S |
| Tylosin | S | S | S | S | S |

S - sensitive

I - intermediate sensitivity

R - resistant

media incorporating glucose they produced positive reactions. It was hypothesized that when glucose was in limited supply, the glucose was used to make type specific capsular material rather than the teichoic acid of group D. In this investigation all streptococci were grown in broth which was not supplemented with glucose and this could account for the failure to produce a precipitate with group D antiserum. Another member of group D streptococci, S. bovis, similarly will not produce the group antigen when grown in media with low levels of glucose. Streptococcus bovis, like S. suis contains glucose within the capsular polysaccharide (Bailey and Oxford, 1959) and when the level of glucose is limited the type specific capsule is made in preference to the group specific antigen.

Perch et al (1981) reported that groups R, S and RS streptococci were different from other species of streptococci in that they have the ability to hydrolyse arginine and to ferment inulin and glycogen. In this investigation all isolates of S. suis produced these same reactions. Similarly no isolate grew in 6.5% NaCl broth. This lack of growth was considered by Homme et al (1986) to be a major criterion for the identification of S. suis. The only apparent biochemical difference between S. suis types 1 and 2 was the failure of S. suis type 1 to ferment raffinose. This finding was also a major taxonomic criterion used by De Moor (1963). Although many workers have reported some variability of S. suis in specific biochemical tests (Table 3.1), in this investigation S. suis was selected for serological identification on the basis of a strict regime as listed in Table 3.2. If biochemical variants of S. suis do exist in New Zealand, they were not identified by this testing system.

Many extracts of the streptococci that were biochemically similar to S. suis types 1 or 2, failed to react with group S or R antiserum. These organisms were biochemically similar to, yet serologically different from S. suis, and may have belonged to the other types of S. suis described by Perch et al (1983). Without antisera to these types, it was not possible to identify these isolates.

The finding that the extract of one isolate of S. suis type 2 lost the ability to react with group R antiserum was similar to the findings of Pedersen et al (1981) and Perch et al (1981). They found that repeated subculturing could lead to the loss of capsule and

consequently the loss of type specific antigen. Perch et al (1983) demonstrated that non-capsulated isolates of S. suis type 2 produced a sediment when grown in broth similar to the findings reported here. Agarwal et al (1969) showed that non-capsulated forms of S. suis type 1 failed to grow in the blood of a piglet whilst a capsulated form multiplied. They believed that the capsule protected the streptococcus from phagocytosis. The loss of the capsule is important, in that it prevents the serological identification of that organism.

The type specific capsular antigen of S. suis type 2 is frequently destroyed by extracting either at a low pH or at high temperatures (Perch et al, 1983). The lability of this antigen was demonstrated in the present work. Only 5% of the extracts of S. suis type 2, prepared at a strongly acidic pH (0.7), reacted with group R antiserum whilst all extracts reacted when prepared at a less acidic pH (1.2).

No isolate of S. suis produced an extract which reacted with antisera to both groups R and S streptococci as occurred with the R/S isolates of Perch et al (1983) and De Moor (1963).

The sensitivity of S. suis to antibiotics has been investigated by many workers. A wide range of antibiotics have been demonstrated to be effective against S. suis in vitro, with most isolates sensitive to penicillin (Nesvadba et al, 1960; Pedersen et al, 1977; Kunter, 1982b). However, Shneerson et al (1980) isolated S. suis type 2 from one case of human meningitis that was resistant to this antibiotic. In the present investigation all isolates were sensitive to penicillin as well as to a range of other antibiotics frequently used for treating pigs (Ireland, 1986). Penicillin has traditionally been the antibiotic of choice for treating both human and animal cases of disease from S. suis type 2 (Joynson, 1980; Clifton-Hadley, 1983a). Penicillin has frequently been added to pig feed in an attempt to control epidemics of infection with S. suis. However, many penicillin derived compounds are heat labile and the high temperatures (in the region of 75°C) reached in extruding meal through a die in the pelleting process may inactivate the antibiotic supplement (Clifton-Hadley, 1983a; Douglas, 1983). Penicillin G is available both as an insoluble procaine salt and a soluble potassium salt and is commonly fed to pigs. Wheeler (1983) showed that the pelleting of feed which had been supplemented

with potassium penicillin G reduced the level of penicillin to 10% of the initial concentration, whilst procaine penicillin was reduced to approximately 40% of initial levels. The addition of molasses, to assist in the pelleting process and to minimize feed costs, further reduced the level of penicillin to less than 1%. Phenoxyethyl penicillin (penicillin V), a water soluble penicillin product, produced higher serum levels of antibiotic than penicillin G when fed in meal, but it was similarly inactivated by the high temperatures of pelleting. Other antibiotics such as lincomycin and tiamulin are heat stable but due to their higher costs are not economical as a feed additive (Wheeler, 1983). Therefore, although an isolate of S. suis is sensitive to an antibiotic, the mixing and processing of that antibiotic in feed may inactivate it and make it an impractical method of treatment.

B. INDIRECT FLUORESCENT ANTIBODY TEST (I.F.A.T.)

INTRODUCTION

The detection of tonsillar carriers of S. suis and the demonstration of these organisms in pathological specimens has traditionally been based on cultural techniques combined with biochemical and precipitin tests (De Moor, 1963; Perch et al, 1981). These methods are time consuming and have low sensitivity (Hunt and Edwards, 1982; Arends et al, 1984). Immunofluorescence has been used successfully for the rapid detection of group A streptococci (Moody et al, 1963; Moody, 1972), group E streptococci of pigs (Schueler et al, 1973) and faecal streptococci (Abshire and Guthrie, 1971; Pugsley and Evison, 1974). Hunt and Edwards (1982) developed a direct fluorescent antibody test for the detection of S. suis type 2 in pathological specimens.

The advantage of immunofluorescent tests include the speed with which the procedure can be performed and the sensitivity of the technique (Cherry et al, 1960). Results from fluorescent antibody tests are available after the smears have been prepared, stained and

examined. These procedures only take a few hours to perform compared to the three days required for the traditional cultural methods. The time taken to perform a fluorescent test may, however, be extended if specimens are cultured and incubated prior to staining. This procedure increases the number of bacteria present in the sample improving the sensitivity of the test. This extra period of incubation may vary from a two hour incubation in broth (Moody et al, 1963) to an 18 hour incubation on blood agar plates (Robertson, 1985a).

The sensitivity of the fluorescent antibody test is limited by the number of organisms present in the smears and the period of time spent examining the smear. Immunofluorescence allows for the identification of very small numbers of specifically stained organisms. The presence of other bacteria, which may interfere with the isolation of a specific bacterium by traditional cultural methods, will not interfere with the fluorescent antibody test (Cherry et al, 1960).

To determine the accuracy of a test, the results of the test under investigation are usually compared with the results from another test. This latter test is assumed to be the more accurate, although it is rarely absolute (Martin, 1984). This problem of the accuracy of a test can be overcome if the disease has a prevalence of 100%. In this case, if all animals are infected then animals identified as negative are true false negatives. In the present work, a true prevalence rate for S. suis types 1 and 2 of 100% is assumed. This assumption is based on work performed by others (Clifton-Hadley et al, 1984b) who have shown that S. suis type 2 are transmitted to healthy non-infected pigs after five days of contact with carriers and that pigs once infected remain infected for over 500 days. Therefore the close contact between pigs in intensive piggeries would ensure the rapid spread of infection throughout the herd. The determination of accuracy of tests will be discussed in more detail later in this chapter.

This section describes the development of the I.F.A.T. as a rapid and accurate tool for use in subsequent epidemiological investigations.

MATERIALS AND METHODS

Antisera

Commercially produced group R and S streptococcal antisera⁹ were used. These antisera, which had been produced in rabbits, were the same as those used in the Lancefield precipitin test. Each antiserum was serially diluted with phosphate buffered saline (PBS-Appendix II) to develop a specific test and to obtain the most economical use of reagents.

Conjugate

Fluorescein labelled goat anti-rabbit immunoglobulin¹⁰ was used after serially diluting with PBS. A checker board series of titrations (as described later) was used to determine the most efficient dilution of conjugate. The antibody content of the undiluted conjugate was 2.5 mg/ml with a fluorescent/protein ratio of 4.5:1.

I.F.A.T. Technique

Swabs taken directly from tissue samples were smeared onto sheep blood agar plates and incubated for 18 hours at 37°C. Smears were made from the areas of heavy bacterial growth of these plates onto clean glass microscope slides. These smears were fixed in acetone at 4°C for ten minutes in a Coplin jar. After fixation, a drop of 0.1% trypsin¹¹ was deposited on the smear and the slide air dried. Each fixed smear was covered with a drop of the diluted group R or S antiserum and incubated in a moisture chamber (a sealed plastic lunch box incorporating racks for slides and moistened tissue paper) at 37°C for 30 minutes (Plate 3.3). Slides were then rinsed and washed three times in baths of PBS for ten minutes per bath. After blotting dry, a drop of the diluted fluorescein labelled anti-rabbit globulin was added and

⁹ Wellcome Reagents Limited, Beckenham, England.

¹⁰ South Pacific Immunological Laboratories Limited, Wellington, New Zealand.

¹¹ Difco Laboratories, Detroit, Michigan, U.S.A.

the slides were incubated in the moisture chamber for a further 30 minutes. After rinsing and washing for 30 minutes in another three baths of PBS, slides were blotted dry and mounted in buffered glycerol (Appendix II) with a number 2 cover slip. The buffered glycerol mounting medium was used to slow down the fading of any fluorescence present (Kawamura, 1969). Slides were examined using ultraviolet illumination with a wavelength of 400 to 490 nm. A Microstar 2071M¹² microscope with a 50 watt mercury vapour lamp or an Olympus¹³ microscope with a 100 watt mercury burner were used at 400 times magnification. Fluorescence was graded from 1+ to 4+ based on the system described by Moody et al (1958), with a 1+ reaction showing weak fluorescence, 2+ showing definite fluorescence of low intensity, 3+ with bright, sharp, clear fluorescence and 4+ with very bright, sharp fluorescence. Fluorescence of 2+ or greater was considered positive.

Dilution of Antisera and Conjugate

Group R and S antiserum and the conjugate were serially diluted with PBS (Appendix II). Chequer-board titrations were performed to determine the optimum concentration of antiserum and conjugate for both S. suis type 1 and 2. This involved fixing numerous smears from cultures of S. suis onto slides and then staining them with a series of dilutions of antisera (1/10 to 1/320) and conjugate (1/10 to 1/80). The weakest dilution of antiserum and conjugate that provided maximum fluorescence was selected for use in further tests.

Specificity of I.F.A.T.

The specificity of the I.F.A.T., for both S. suis types 1 and 2, was determined by staining isolates of S. suis types 1 and 2 as well as other bacterial species and examining for fluorescence. Streptococcus suis types 1 and 2 were isolated from the tonsils of apparently healthy pigs as well as from samples collected post mortem.

¹² American Optical Scientific Instrument Division,
Buffalo, New York.

¹³ Olympus Optical Co., Ltd, Tokyo Japan

All of the isolates stained were identified by means of cultural, biochemical and precipitin tests as described earlier. Other streptococcal and bacterial species were isolated either from the tonsils of pigs collected at a meatworks, from pathological specimens or obtained from the freeze dried collection of the Department of Veterinary Pathology and Public Health, Massey University.

Comparison of I.F.A.T. with Cultural Techniques for Demonstrating S. suis in the Tonsils

One palatine tonsil from each of 89 pigs slaughtered at a meatworks were collected and returned to the laboratory within two hours. The pigs originated from eight herds, six of which had previously been shown to be infected with S. suis type 2 and four with S. suis type 1. Tonsils were sectioned two or three times in a plane either parallel to or perpendicular to the buccal surface. Swabs of the incised surface were initially plated onto sheep blood agar plates and then smeared directly onto microscope slides. Agar plates were incubated for 18 hours at 37°C and swabs taken from the region of heavy bacterial growth and smears made on microscope slides. Smears made from both the direct tonsillar swab and the primary cultural growth were stained with an I.F.A.T. The results obtained from the I.F.A.T. were compared with those from isolation and identification of S. suis by cultural, biochemical and precipitin tests from the growth of the same swabs.

Comparison of I.F.A.T. on Primary Culture with Cultural Techniques for Demonstrating S. suis in Nasal Swabs

Nasal swabs were collected from 60 pigs after stunning but prior to exsanguination at the meatworks. These pigs originated from two herds, from which S. suis types 1 and 2 had previously been isolated. The swab¹⁴ was inserted approximately three cm into the nasal cavity and rotated on the mucosa. Swabs were plated onto sheep blood agar and incubated for 18 hours at 37°C. Alpha haemolytic colonies were selected and subcultured to obtain a pure culture, and biochemical and

¹⁴ Hospiswab Medical Wire and Equipment Ltd, Corsham, Wiltshire, England

precipitin tests were performed on these to identify isolates of S. suis. Smears were also made from the area of heavy mixed bacterial growth on the primary culture and subjected to the I.F.A.T. The results obtained from the conventional cultural technique were compared with those of the I.F.A.T on the primary growth.

Comparison of the I.F.A.T. on the Primary Growth of Nasal and Tonsillar Swabs for Demonstrating S. suis

Nasal swabs were collected from 50 pigs prior to exsanguination as described above. These pigs originated from three herds, from which both S. suis types 1 and 2 had previously been isolated. One palatine tonsil was also collected from each pig within 30 minutes of exsanguination. The I.F.A.T. was carried out on the primary culture of both tonsillar and nasal swabs and the results compared.

Comparison of Sheep Blood Agar with Edwards' Medium as Primary Culture Medium prior to use of I.F.A.T.

Swabs were taken from the incised surface of palatine tonsils collected from 74 pigs. These pigs came from five herds, three of which had previously been detected as being infected with S. suis type 2 and two with S. suis type 1. The tonsillar swabs were initially plated onto Columbia Base Agar containing 5% sheep blood and then onto Edwards Medium (modified)¹⁵. Smears were again taken from the areas of heavy bacterial growth on both media, subjected to the I.F.A.T. and results compared.

RESULTS

The minimum dilutions of antisera and conjugate needed to produce maximum (4+) fluorescence when tested against homologous strains of S. suis, were 1 in 80 and 1 in 40 respectively (Tables 3.4 and 3.5). Plate 3.4 shows S. suis type 2 stained with the I.F.A.T. The coccoid nature and short chains of the streptococcus are apparent.

¹⁵ Oxoid Limited, Basingstoke, Hampshire, England.

TABLE 3.4

FLUORESCENCE* OF S. SUIS TYPE 1 AT VARIOUS DILUTIONS
OF CONJUGATE AND ANTISERA

| GROUP S STREPTOCOCCAL ANTISERUM | FLUORESCEIN LABELLED CONJUGATE DILUTION | | | |
|---------------------------------------|---|------|------|------|
| | 1/10 | 1/20 | 1/40 | 1/80 |
| 1/10 | 4+ | 4+ | 4+ | 2+ |
| 1/20 | 4+ | 4+ | 4+ | 2+ |
| 1/40 | 4+ | 4+ | 4+ | 2+ |
| 1/80 | 4+ | 4+ | 4+ | 2+ |
| 1/160 | 2+ | 2+ | 1+ | 1+ |
| 1/320 | 1+ | 1+ | 1+ | 1+ |

TABLE 3.5

FLUORESCENCE* OF S. SUIS TYPE 2 AT DIFFERENT
CONCENTRATIONS OF GROUP R CONJUGATE AND ANTISERUM

| GROUP R STREPTOCOCCAL ANTISERUM | FLUORESCEIN LABELLED CONJUGATE DILUTION | | | |
|---------------------------------------|---|------|------|------|
| | 1/10 | 1/20 | 1/40 | 1/80 |
| 1/10 | 4+ | 4+ | 4+ | 2+ |
| 1/20 | 4+ | 4+ | 4+ | 2+ |
| 1/40 | 4+ | 4+ | 4+ | 2+ |
| 1/80 | 4+ | 4+ | 4+ | 1+ |
| 1/160 | 3+ | 2+ | 2+ | 1+ |
| 1/320 | 1+ | 1+ | 1+ | 1+ |

* fluorescence 1+ = weak
2+ = low intensity
3+ = bright and clear
4+ = very bright and sharp

PLATE 3.3

THE MOISTURE CHAMBER USED IN THE IMMUNOFLUORESCENT TESTS

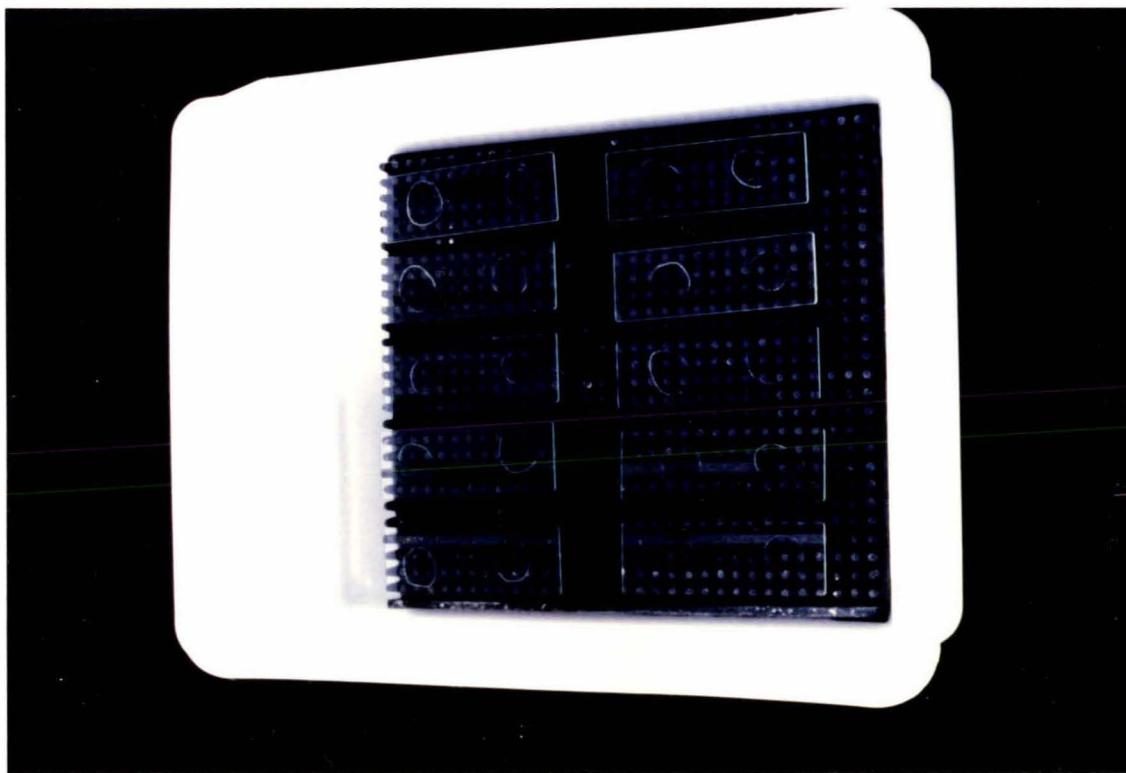
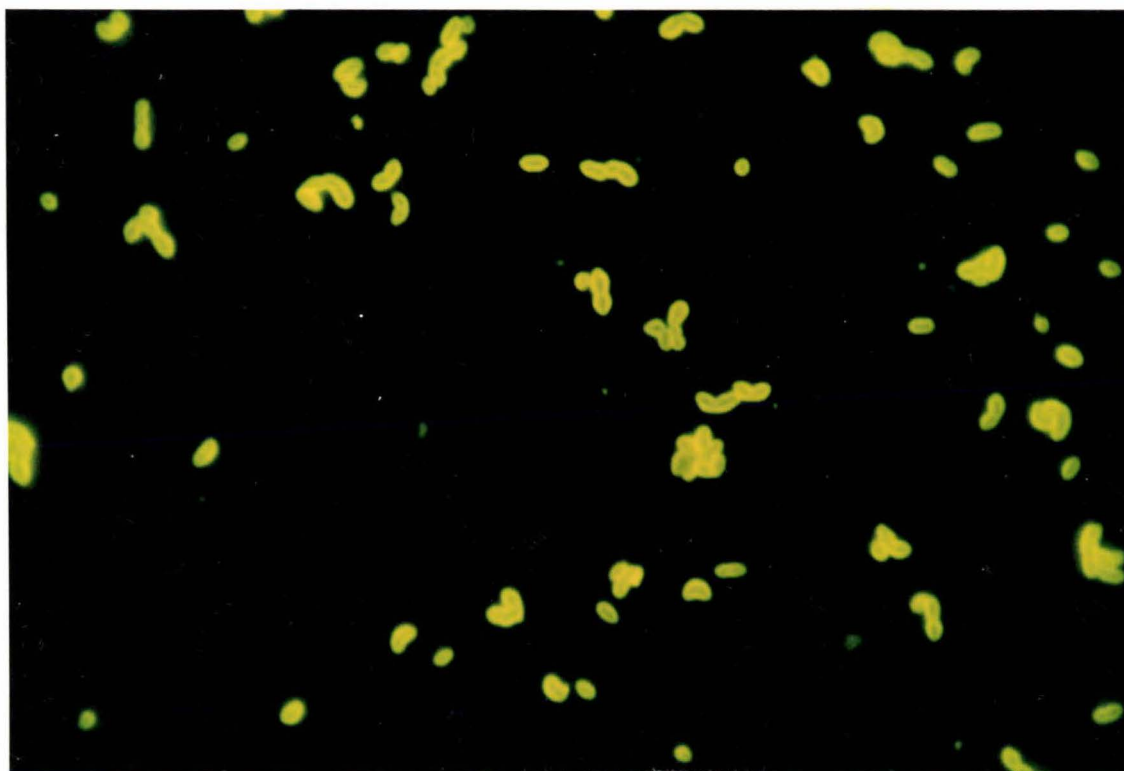

PLATE 3.4

S. SUIS TYPE 2 STAINED WITH AN I.F.A.T.



The I.F.A.T. appeared highly specific for S. suis when the homologous antiserum was used (Table 3.6 and 3.7). All isolates of S. suis type 2 showed very bright fluorescence (4+) when stained with a 1/80 dilution of group R antiserum, while no more than a faint reaction (1+) was obtained from other streptococcal or bacterial species. Similarly only S. suis type 1 produced a 4+ fluorescence when stained with homologous group S antiserum. There were no cross reactions between the two types of S. suis.

Assuming a true prevalence of 100%, the sensitivity of the three techniques (cultural, I.F.A.T. on a direct smear and I.F.A.T. on the primary bacterial growth) for detecting S. suis in the tonsils are compared in Tables 3.8 and 3.9. The sensitivity of cultural methods for detecting S. suis type 2 was only 15%, compared with 67% for an I.F.A.T. performed directly on tonsillar swabs. However, an I.F.A.T. on the mixed growth from a tonsillar swab incubated on blood agar for 18 hours, increased the sensitivity to 76%. Similarly the sensitivity for detecting S. suis type 1 increased from 12% for traditional cultural methods, to 46% with an I.F.A.T. on tonsillar swabs and 62% with an I.F.A.T. of smears from the bacterial growth from tonsillar swabs. There was a significant difference between the number of positive swabs for the three methods for both S. suis types 1 and 2 ($p < 0.0001$). Positive fluorescence, for both S. suis types 1 and 2, was detected in some pigs from all herds, including those from which S. suis had not previously been detected by the traditional microbiological techniques.

When swabs were taken from tonsils incised at right angles to the oropharyngeal surface 77% (17/22) showed positive fluorescence for S. suis type 2, compared with 68% when swabs were taken from the same tonsils incised parallel to their surface. There was no significant difference ($p > 0.4$) between the number of positive swabs detected by either method of sampling.

In Tables 3.10 and 3.11 the cultural and fluorescent findings of 60 nasal swabs, taken from two herds, are compared for both S. suis types 1 and 2. When an I.F.A.T. was performed on the primary bacterial growth, S. suis type 2 was detected in 60% of swabs and S. suis type 1 in 48% compared with only 3% and 2% when the traditional cultural

TABLE 3.6

SPECIFICITY OF THE I.F.A.T. FOR S. SUIS TYPE 2 WITH GROUP R ANTISERUM

| ORGANISM | NUMBER TESTED | FLUORESCENCE | | | |
|-----------------------|---------------|--------------|----|----|----|
| | | 4+ | 3+ | 2+ | 1+ |
| <u>S. suis</u> type 2 | 33 | 33 | - | - | - |
| Group A streptococci | 2 | - | - | - | 2 |
| Group B streptococci | 1 | - | - | - | 1 |
| Group C streptococci | 4 | - | - | - | 4 |
| Group D streptococci | 2 | - | - | - | 2 |
| Group P streptococci | 2 | - | - | - | 2 |
| Group S streptococci | 20 | - | - | - | 20 |
| <u>S. uberis</u> | 1 | - | - | - | 1 |
| <u>S. viridans</u> | 27 | - | - | - | 27 |
| <u>Staph. aureus</u> | 7 | - | - | - | 7 |
| Micrococcus sp. | 2 | - | - | - | 2 |
| <u>E. coli</u> | 3 | - | - | - | 3 |

TABLE 3.7

SPECIFICITY OF THE I.F.A.T. FOR S. SUIS TYPE 1 WITH GROUP S ANTISERUM

| ORGANISM | NUMBER TESTED | FLUORESCENCE | | | |
|-----------------------|---------------|--------------|----|----|----|
| | | 4+ | 3+ | 2+ | 1+ |
| <u>S. suis</u> type 1 | 20 | 20 | - | - | - |
| Group A streptococci | 2 | - | - | - | 2 |
| Group B streptococci | 1 | - | - | - | 1 |
| Group C streptococci | 4 | - | - | - | 4 |
| Group D streptococci | 2 | - | - | - | 2 |
| Group P streptococci | 2 | - | - | - | 2 |
| Group R streptococci | 33 | - | - | - | 33 |
| <u>S. uberis</u> | 1 | - | - | - | 1 |
| <u>S. viridans</u> | 27 | - | - | - | 27 |
| <u>Staph. aureus</u> | 7 | - | - | - | 7 |
| Micrococcus sp. | 2 | - | - | - | 2 |
| <u>E. coli</u> | 3 | - | - | - | 3 |

TABLE 3.8

COMPARISON OF CULTURAL AND IMMUNOFLUORESCENT TESTS
(I.F.A.T.) FOR THE DETECTION OF S. SUIS TYPE 2

| TEST | TOTAL NUMBER OF PIGS TESTED | TOTAL NUMBER OF SWABS COLLECTED | NUMBER OF POSITIVE SWABS | SENSITIVITY OF TEST %* |
|-----------------------------------|-----------------------------------|---------------------------------------|--------------------------------|------------------------------|
| Culture | 89 | 171 | 25 | 15 |
| I.F.A.T. of Direct Smear | 28 | 68 | 46 | 67 |
| I.F.A.T. of Primary Culture | 89 | 171 | 130 | 76 |

* - 100% prevalence assumed

TABLE 3.9

COMPARISON OF CULTURAL AND IMMUNOFLUORESCENT TESTS
FOR THE DETECTION OF S. SUIS TYPE 1

| TEST | TOTAL NUMBER OF PIGS TESTED | TOTAL NUMBER OF SWABS COLLECTED | NUMBER OF POSITIVE SWABS | SENSITIVITY OF TEST %* |
|-----------------------------------|-----------------------------------|---------------------------------------|--------------------------------|------------------------------|
| Culture | 46 | 98 | 12 | 12 |
| I.F.A.T. of Direct Smear | 22 | 48 | 22 | 46 |
| I.F.A.T. of Primary Culture | 46 | 98 | 61 | 62 |

* - 100% prevalence assumed

TABLE 3.10

COMPARISON OF CULTURAL AND IMMUNOFLUORESCENT
TESTS ON NASAL SWABS FOR S. SUIS TYPE 2

| TEST | TOTAL NUMBER OF PIGS | NUMBER OF POSITIVE NASAL SWABS | SENSITIVITY OF TEST FOR DETECTING INFECTED ANIMALS (%)* |
|--------------------------------|----------------------------|--------------------------------------|--|
| Culture | 60 | 2 | 3 |
| I.F.A.T. on Primary Culture | 60 | 36 | 60 |

* - 100% prevalence assumed

TABLE 3.11

COMPARISON OF CULTURAL AND IMMUNOFLUORESCENT
TESTS ON NASAL SWABS FOR S. SUIS TYPE 1

| TEST | TOTAL NUMBER OF PIGS | NUMBER OF POSITIVE NASAL SWABS | SENSITIVITY OF TEST FOR DETECTING INFECTED ANIMALS (%)* |
|--------------------------------|----------------------------|--------------------------------------|--|
| Culture | 60 | 1 | 2 |
| I.F.A.T. on Primary Culture | 60 | 29 | 48 |

* - 100% prevalence assumed

methods were used. There was a significant difference ($p < 0.0001$) between the numbers of nasal swabs detected as positive for S. suis types 1 and 2 by the I.F.A.T. compared with the traditional cultural methods.

Tables 3.12 and 3.13 record the level of detection of S. suis types 2 and 1 respectively, from an I.F.A.T. performed on the primary growth of nasal and tonsillar swabs collected from the same animals. In Table 3.12, 68% (34/50) of pigs were classified as positive for S. suis type 2 when the I.F.A.T. was carried out on the growth from tonsillar swabs, compared to 52% (26/50) when using the growth from nasal swabs. Nasal swabs were negative in 28% (14/50) of pigs that were positive on tonsillar swabbing. Conversely only 12% (6/50) of tonsillar swabs were negative from pigs which had positive nasal swabs. There was no significant difference ($p > 0.1$) between the number of animals detected as being infected with S. suis type 2 by an I.F.A.T. on tonsillar swabs, and those identified by an I.F.A.T. on nasal swabs. Table 3.13 shows that when an I.F.A.T. for S. suis type 1 was performed on the growth from tonsillar swabs 56% (28/50) were positive, compared with 34% (17/50) when nasal swabs were used. Nasal swabs were negative in 24% (12/50) of pigs that were positive for S. suis type 1 on tonsillar swabbing, whilst only 2% (1/50) of pigs with negative tonsillar swabs had positive nasal swabs. There was a significant difference ($p < 0.05$) between the number of animals which were detected as infected with S. suis type 1 by an I.F.A.T. on tonsillar swabs, and those identified by an I.F.A.T. on nasal swabs.

Tables 3.14 and 3.15 compare the results of the I.F.A.T. on the growth from tonsillar swabs on sheep blood agar with the results from Edwards' Medium, for S. suis types 2 and 1 respectively. When an I.F.A.T. was used on the bacterial growth from tonsillar swabs cultured on Edwards' Medium, 74% (55/74) of tonsils were classified as infected with S. suis type 2, compared to 56% (41/74) when the I.F.A.T. was done on the growth of the same tonsillar swab cultured on sheep blood agar. However, this difference was not significant ($p > 0.1$). Tests on the growth from sheep blood agar failed to detect 23% (17/74) of pigs that were classed as positive when the same test was performed on the growth from Edwards' medium. Only 4% (3/74) were negative from the growth on Edwards' medium yet positive on the sheep blood agar (Table 3.14). Similarly for S. suis type 1, 56% (41/74) of tonsillar

TABLE 3.12

COMPARISON OF NASAL AND TONSILLAR SWABS FOR DETECTING
S. SUIIS TYPE 2 WITH THE I.F.A.T.

| I.F.A.T. RESULT | | NUMBER OF PIGS EXAMINED |
|----------------------|----------------|----------------------------|
| Nasal Swab | Tonsillar Swab | |
| + | + | 20 |
| + | - | 6 |
| - | + | 14 |
| - | - | 10 |
| Total Number of Pigs | | 50 |

+ = All pigs in group were positive to test

- = All pigs in group were negative to test

TABLE 3.13

COMPARISON OF NASAL AND TONSILLAR SWABS FOR THE DETECTION
OF S. SUIIS TYPE 1 WITH THE I.F.A.T.

| I.F.A.T. RESULT | | NUMBER OF PIGS EXAMINED |
|----------------------|----------------|----------------------------|
| Nasal Swab | Tonsillar Swab | |
| + | + | 16 |
| + | - | 1 |
| - | + | 12 |
| - | - | 21 |
| Total Number of Pigs | | 50 |

+ = All pigs in group were positive to test

- = All pigs in group were negative to test

TABLE 3.14

COMPARISON OF 5% SHEEP BLOOD AGAR WITH EDWARDS MEDIUM
FOR THE DETECTION OF TONSILLAR CARRIERS
OF S. SUIS TYPE 2 USING I.F.A.T.

| Blood Agar | I.F.A.T. RESULT | | NUMBER OF PIGS |
|----------------------|-----------------|----------------|----------------|
| | | Edwards Medium | |
| + | + | | 38 |
| + | - | | 3 |
| - | + | | 17 |
| - | - | | 16 |
| Total Number of Pigs | | | 74 |

+ All pigs in group were positive to test
- All pigs in group were negative to test

TABLE 3.15

COMPARISON OF 5% SHEEP BLOOD AGAR WITH EDWARDS MEDIUM
FOR THE DETECTION OF TONSILLAR CARRIERS
OF S. SUIS TYPE 1 USING I.F.A.T.

| Blood Agar | I.F.A.T. RESULT | | NUMBER OF PIGS |
|----------------------|-----------------|----------------|----------------|
| | | Edwards Medium | |
| + | + | | 29 |
| + | - | | 5 |
| - | + | | 12 |
| - | - | | 28 |
| Total Number of Pigs | | | 74 |

+ All pigs in group were positive to test
- All pigs in group were negative to test

swabs grown on Edwards' medium were positive on an I.F.A.T. compared with only 46% (34/74) when the same swabs were grown on sheep blood agar. This difference was not significant ($p > 0.2$). An I.F.A.T. on the growth from swabs plated onto sheep blood agar failed to detect 16% (12/74) of pigs that were identified as infected with S. suis type 1 by an I.F.A.T. performed on bacterial growth from Edwards' Medium. However only 7% (5/74) of samples were negative on Edwards' Medium and yet positive on the sheep blood agar (Table 3.15).

In summary, S. suis type 2 was detected in 76% and 60% of tonsillar and nasal swabs respectively, when an I.F.A.T. was used on the primary bacterial growth. When cultural, biochemical and precipitin tests were used, only 15% and 3% of tonsillar and nasal swabs were positive for S. suis type 2. Similarly for S. suis type 1, 62% and 48% of tonsillar and nasal swabs were positive when the I.F.A.T. was used on the primary bacterial growth, compared with only 12% and 2% when cultural, biochemical and precipitin tests were used.

DISCUSSION

As indicated in the introduction to this thesis a major facet of any epidemiological investigation is determining the strength of possible causal associations. This obviously requires certain biometric techniques which express the probability of any association not being purely a matter of chance. Often differences between groups are considered to be significant only when there is more than a 95% probability that they have not occurred by chance. Thus probability values (p) greater than 0.05 are seldom quoted. However the greater the p value, the greater the probability that there is no association between the hypothetical causes and effects. Evidence of a lack of difference is often as important as evidence of a significant difference when attempting to unravel an epidemiological problem. Thus in this and later chapters p values are recorded irrespective of their magnitude, with values greater than 0.5 being highly non-significant.

The dilution of antiserum and conjugate with PBS to 1 in 80 and 1 in 40 respectively, allowed for both the development of a highly specific I.F.A.T. and the economical use of reagents. Identification of colonies of S. suis takes at least three days when using cultural,

biochemical and precipitin tests, whilst a positive diagnosis can be achieved within one day with the use of the immunofluorescent technique described here. The work reported here shows that the I.F.A.T. is a rapid and more accurate test for the detection of pigs infected with S. suis than conventional cultural techniques. The I.F.A.T. when applied to primary cultures, increased the detection rate of infected pigs both from post mortem tonsillar swabs and ante mortem nasal swabs, when compared with traditional cultural methods.

Previous workers have shown that S. suis can be isolated from the palatine tonsils and it would appear that this tissue is a carrier site for S. suis (Williams *et al*, 1973; Clifton-Hadley and Alexander, 1980). Although S. suis types 1 and 2 were detected from nasal swabs in the present work, it cannot be inferred that the nasal chambers are either carrier sites or actively infected with S. suis. It would appear likely that S. suis is passively shed from the tonsil into the nose. Thus, if S. suis is detected in nasal swabs, it is assumed that the palatine tonsils are infected. This differentiation between merely the presence of an organism in a tissue or organ and active infection (tissue invasion and multiplication) is important and will be discussed further in other chapters.

Although the I.F.A.T. requires an extra step compared with a direct fluorescent antibody test, it has the advantages of using commercially available reagents and is more sensitive than the direct F.A.T. (Cherry *et al*, 1966; Kawamura, 1969). A disadvantage of the I.F.A.T. can be a lowered specificity caused by staining of antibody that failed to unite with antigen not removed during washing. In the present experiment, there were no false reactions with other bacterial species so it was assumed that any excess antibody was removed by the washing and rinsing procedures. If the assumption that 100% of pigs are infected with S. suis is correct, there would be no non-infected animals and consequently there could not be any false positive reactions.

To determine the accuracy of any test, the results must be compared to a "bench mark" which is assumed to be a more accurate test. For instance, results from intradermal tuberculin tests are compared with findings post mortem and cultural examinations. However

these latter techniques are not absolute. Many endemic bacterial infections of animals (especially those with a short prepatent period followed by a long period of shedding) appear to occur at a prevalence rate close to 100%. For instance, most pigs are infected with Mycoplasma hyopneumoniae (Switzer and Ross, 1975) and all conventionally housed laboratory mice and rats are infected with Pasteurella pneumotropica (Casillo and Blackmore, 1972). Infection of pigs with S. suis also fits into this category, as they have a recorded prepatent period of only five days and a long duration of infection of greater than 500 days (Clifton-Hadley et al, 1984b). If an infection appears to be one that is likely to occur at prevalence rates approaching 100%, then the tests designed to detect such an infection do not have to be compared with other techniques. In such circumstances all test negatives can be assumed to be false negatives and the subsequent calculation of the sensitivity of the test can not be an overestimate. However the specificity of the test cannot be calculated from the results obtained, as if there is a 100% prevalence there will be no "non-diseased" animals and therefore no false positives. In such circumstances the specificity can only be calculated by laboratory tests involving different but known organisms, as were performed in this investigation. In the present studies, no cross reactions occurred with other bacteria.

If we assume that S. suis has a generation time of 40 minutes, after 18 hours of incubation one organism will have become a colony of more than 10^8 organisms. Therefore only one colony has to be included on a swab of the bacterial growth to provide ample bacteria to produce a positive result from the I.F.A.T. This was evident in this investigation, where numerous fluorescing streptococci were present in smears from the bacterial growth of positive swabs. When a swab was taken of the heavy bacterial growth, approximately 10% of the growth was sampled. If it is assumed colonies of S. suis are randomly distributed through the bacterial growth, to pick up one colony on the swab at least ten must be present on the plate. As each colony started from one viable organism, at least ten viable organisms must be collected by the initial swab of the nose or tonsil. If the number of organisms initially present is less than ten, the probability of detecting a colony is lower and the sensitivity of the test is decreased. If there are more than ten organisms present in a nasal or tonsillar swab, then there is a very high probability of detecting

organisms by fluorescent staining. In the present work, it was shown that by increasing the number of swabs taken from the same tonsil more positive tonsils were detected than if only one swab was examined. Similarly if more swabs had been taken from each culture plate, it might be expected that the number of pigs identified as positive would increase. Therefore, the sensitivity of the I.F.A.T. is dependant on the number of viable organisms of S. suis present on the initial swab. Assuming that both S. suis types 1 and 2 are present in a 100% of the palatine tonsils, the fewer tonsils detected as being infected with S. suis type 1 (sensitivity) is probably associated with the presence of fewer organisms rather than a lower prevalence of infection.

In the present investigation, the I.F.A.T. was more sensitive when performed on the growth from tonsillar swabs than on the growth from nasal swabs. However, the sensitivity of the I.F.A.T. for detecting S. suis within the nose may be as high as that for detecting them in the palatine tonsils. If only intermittent shedding of S. suis occurs from the tonsils to the nose, then not all pigs will have S. suis present within their noses at one particular time. This may account for the lower rate of detection from nasal swabs when compared with tonsillar swabs. Therefore, an I.F.A.T. performed on the growth from nasal swabs, although of lower sensitivity for detecting infected animals than an I.F.A.T. on the growth from tonsillar swabs, is probably as sensitive for actually detecting the presence of S. suis.

A serious disadvantage of the conventional cultural, biochemical and precipitin isolation techniques is the difficulty in detecting colonies of S. suis in the presence of a heavy growth of other bacteria present in the tonsil or nasal cavity. Swarming organisms, such as Proteus spp. and other rapidly growing bacterial colonies, frequently interfered with the isolation of S. suis types 1 and 2 by the traditional microbiological techniques and consequently lowered the tests' sensitivity. Clifton-Hadley et al (1985) recorded that the direct fluorescent antibody test, developed by Hunt and Edwards (1982), was unsuitable for use on mixed populations of bacteria because of non-specific reactions with other bacteria, however they offered no evidence to substantiate this assertion. In the present investigation, the I.F.A.T. was shown to be highly specific and other bacterial species found in the tonsil appeared not to interfere with the test. Clifton-Hadley et al (1984b) found that swabs from porcine

tonsils yielded mixed cultures of streptococci. They found that the appearance of colonies of S. suis type 2 varied and the haemolytic zones of other streptococci often masked colonies of S. suis type 2. Many of these other streptococci were similar in appearance to S. suis type 2 and yet serologically distinct. When cultural techniques were used, further subculturing and biochemical tests had to be done to identify the colonies. In the present investigation, it was found that swabs taken from areas of heavy bacterial growth frequently showed positive fluorescence after staining with the I.F.A.T., whilst no S. suis were demonstrated in cultures from these samples. The higher sensitivity of the I.F.A.T. was one of the major advantages of this test and provided a valuable tool for investigating the epidemiology of infection with S. suis.

Pavlova et al (1972) and Pugsley and Evison (1974) recorded false positive reactions to Staphylococcus aureus, when an I.F.A.T. was performed using their group D streptococcal antiserum. These false positives were removed by pre-treatment of bacterial smears with 0.1% trypsin. In the present investigation, no cross reactivity occurred when group R or S antiserum was tested against other bacteria. The technique of fixing the smear in acetone prior to staining may also act in the same way as trypsin, altering the cells to allow adherence of the antiserum to the specific binding site. In the present investigation, the addition of the 0.1% trypsin appeared to slightly enhance the intensity of staining and was routinely used on smears prior to staining.

As discussed earlier, the determination of the accuracy of a test usually involves the comparison of one test with another. In the present circumstances where a 100% prevalence is assumed, this is not necessary. In this situation, the sensitivity can be accurately calculated by determining the proportion of samples that are positive to the test. Table 3.16 records the number of pigs that have to be sampled by either nasal or tonsillar swabbing to be 95% confident that infection is present or absent in a herd. The I.F.A.T. was more than five times more sensitive for detecting S. suis from tonsillar swabs and over twenty times more sensitive for nasal swabs than were the traditional microbiological techniques. Due to the high sensitivity of the I.F.A.T. on primary culture, only four and three pigs have to be sampled to have a 95% chance of detecting infection in the palatine

TABLE 3.16

THE NUMBER OF PIGS TO SAMPLE TO BE 95% CONFIDENT OF DETECTING
THE PRESENCE OF INFECTION WITH S. SUIS*

| | <u>S. SUIS TYPE 1</u> | | <u>S. SUIS TYPE 2</u> | |
|--|-------------------------------|---------------------------------------|-------------------------------|---------------------------------------|
| | SENSITIVITY OF TEST (%) | NUMBER OF ANIMALS TO BE TESTED* | SENSITIVITY OF TEST (%) | NUMBER OF ANIMALS TO BE TESTED* |
| TONSILLAR SWABS | | | | |
| I.F.A.T. on Primary Culture | 62 | 4 | 76 | 3 |
| Direct I.F.A.T. | 46 | 5 | 67 | 3 |
| Traditional Microbiological Techniques | 12 | 24 | 15 | 19 |
| NASAL SWABS | | | | |
| I.F.A.T. on Primary Culture | 48 | 5 | 60 | 4 |
| Traditional Microbiological Techniques | 2 | 149 | 3 | 99 |

* - Assumes 100% prevalence of infection

tonsils with S. suis types 1 and 2 respectively. If the traditional techniques were used, 24 and 19 animals would need to have been sampled. Similarly if an I.F.A.T. is performed on the primary growth of nasal swabs, only five and four animals need to be sampled to detect S. suis types 1 and 2 respectively, compared with 149 and 99 with traditional methods. The poor sensitivity of the traditional microbiological techniques accounts for the low levels or even the apparent absence of infection reported by other workers.

Moody et al (1963) increased the sensitivity of their fluorescent antibody test by incubating swabs for two hours in broth prior to staining the broth sediment. A similar increase in the sensitivity of the I.F.A.T. was demonstrated in the present study, after swabs had been incubated for 18 hours on sheep blood agar. Arends et al (1984) found that S. suis type 2 was frequently found in small numbers in the tonsil. The incubation of tonsillar swabs is therefore likely to allow the multiplication of the organism to a detectable level. Roberts and Sherris (1967) demonstrated a blocking antibody that coated group A streptococci present in swabs taken directly from the oropharynx of humans. This blocking antibody interfered with the fluorescent staining of such streptococci. This host antibody was inhibited by allowing the organisms to grow for several hours prior to performing a fluorescent stain (Cole and Hahn, 1962; Rauch and Rantz, 1963). The enhanced sensitivity of performing an I.F.A.T. on the bacterial growth produced after a period of incubation, may be due to either an increase in the number of organisms or to inhibition of antigen-antibody complexes.

Arends et al (1984) sectioned tonsils at a plane parallel to their buccal surface and thereby at right angles to the crypts. They found that most colonies of S. suis type 2 were confined to the crypts. They believed that by taking a section that included many crypts, they had a greater chance of detecting infection. However, in this investigation there was no significant difference ($p > 0.5$) between the detection of S. suis from tonsillar swabs when taken at a plane either parallel to or at right angles to the tonsillar surface.

The I.F.A.T. when performed on the growth from tonsillar swabs showed greater sensitivity than the I.F.A.T. on the growth from nasal swabs collected from the same animal for both S. suis types 1 and 2

(68% compared with 52% for S. suis type 2 and 56% compared with 34% for S. suis type 1). The disadvantage with the I.F.A.T. on growth from tonsillar swabs, as described here, is that samples can only be collected post mortem. However the advantage of nasal swabs is that they can be collected from live animals if adequate restraint is available. Table 3.16 shows that only five animals had to be sampled by nasal swabbing to be 95% confident of the presence or absence of infection in a herd.

The use of Edwards' medium, a selective medium for streptococci (Carter, 1973), also enhanced the detection of both S. suis types 1 and 2 compared with sheep blood agar (74% compared with 56% for S. suis type 2 and 56% compared with 46% for S. suis type 1). Although Edwards' medium did improve the sensitivity of the I.F.A.T., this advantage was offset by the increased cost of this medium. The abundant supply of blood agar plates in most routine microbiological laboratories makes them the media of choice. In all but the smallest herds the slightly lower sensitivity of the I.F.A.T. on the bacterial growth from sheep blood agar is acceptable. If one carrier is detected in a herd, a prevalence approaching 100% can be assumed in pigs after weaning. The I.F.A.T. used for investigating the epidemiology of S. suis as described in the following chapters, all involved staining bacterial growth cultured on sheep blood agar.

CONCLUSIONS

1. With cultural, biochemical and serological tests it was shown that both S. suis types 1 and 2 were present in the palatine tonsils of New Zealand pigs.
2. Many streptococci biochemically similar to, yet serological different from, S. suis can be isolated from the palatine tonsils. These organisms may belong to other types of S. suis besides S. suis types 1 and 2.
3. The capsular polysaccharide of S. suis type 2 is inactivated at a pH less than 1.

4. An I.F.A.T. was developed for S. suis that was easy and quick to perform. This test showed a 100% specificity on in vitro tests.

5. The I.F.A.T., when performed on tonsillar swabs or the bacterial growth from tonsillar swabs, was more sensitive for detecting both S. suis types 1 and 2 than traditional microbiological methods. If a 100% prevalence is assumed, traditional microbiological methods detected only 15% of pigs infected with S. suis type 2, whilst the I.F.A.T. on tonsillar swabs detected 67% of the infected pigs and the I.F.A.T. on the primary growth detected 76%. Similarly for S. suis type 1, traditional methods could identify only 12% of infected pigs whilst the I.F.A.T. on direct swabs found 46% and the I.F.A.T. on the primary bacterial growth detected 62%.

6. The I.F.A.T. on growth from nasal swabs was more sensitive than traditional cultural methods from the same swabs. Traditional methods could detect only 2% and 3% of pigs infected with S. suis types 1 and 2 whilst the I.F.A.T. on the primary growth detected 48% and 60% respectively.

7. The I.F.A.T. on tonsillar swabs is more sensitive than nasal swabs from the same animal, however nasal swabs can be collected from live pigs.

8. An I.F.A.T. on the growth from tonsillar swabs on Edwards' medium detected more infected pigs than the growth on sheep blood agar from the same swabs.

9. The I.F.A.T. is a valuable tool for investigating the epidemiology of infection with S. suis in pigs.

C. ENZYME LINKED IMMUNOSORBENT ASSAY (ELISA)

STANDARDIZATION OF THE ELISA TEST

INTRODUCTION

Several serological tests have been used to detect type specific antibodies against S. suis. Agarwal et al (1969) developed a bactericidal test for detecting opsonizing antibodies to S. suis type 1. They identified antibody, in adult pigs, to the capsular polysaccharide of S. suis type 1. This antibody was believed to be IgM. Sera collected from pigs that had been reared in a "pathogen free environment" did not, however, contain this antibody. Elliot et al (1980) also used the bactericidal test to detect opsonizing antibodies against S. suis type 2. However they considered the test was non-specific, as sera collected from pigs originating from herds believed to be free of S. suis type 2 also gave positive results. These cross-reactions were assumed to be from reactions with immunoglobulin produced against atypical strains of S. suis type 2 or other species of bacteria. Based on the work reported in the preceding sections, it is probable that these workers falsely classified herds as free from infection with S. suis type 2 because of the use of a test with low sensitivity. Thus in reality their serological results were probably specific. Clifton-Hadley (1984) reported that the bactericidal test had the disadvantages of being non-quantitative, laborious and time consuming.

Clifton-Hadley (1984) used several serological tests to investigate the circulating antibodies in pigs against S. suis type 2. She found that a phagocytic test, using purified pig neutrophils, was too insensitive to detect these circulating antibodies. However, this test did demonstrate that non-capsulated variants of S. suis type 2 were readily phagocytosed by neutrophils whilst the capsulated strains were not. Although a mixed reverse passive antiglobulin haemagglutination test (M.R.P.A.H.) measured the amount of specific antibody binding to S. suis type 2, it lacked specificity. This lack of specificity was believed to be caused by the use of whole organisms of S. suis type 2 which possessed both group specific as well as type specific antigens. Clifton-Hadley (1984) proposed that the specificity

would be improved if type specific capsular polysaccharide was used as the antigen. An indirect haemagglutination test, that utilized sheep red blood cells linked to the type specific polysaccharide for S. suis type 2, was also used by Clifton-Hadley (1984) for measuring antibodies to S. suis type 2. This test was simple to perform, semi-quantitative and allowed many samples to be tested simultaneously, however false positive results were again recorded from sera collected from pigs believed to be free of infection with S. suis type 2.

The ELISA originally devised by Engvall and Perlmann (1971) has become an important tool for the detection of both antigens and antibodies (Elder et al, 1982). The ELISA can provide a cheap, rapid and simple method for detecting antibody within the serum (Voller et al, 1976; 1980; Bolton et al, 1982). Adaptations of the ELISA have been employed in the serodiagnosis of a wide range of infectious diseases including bacterial, mycotic, parasitic and viral infections (Voller et al, 1980).

Clifton-Hadley et al (1984b) developed an ELISA which offered the advantages of speed, the capacity for processing large numbers of serum samples and was quantitative. However, like other serological tests, the test was reported to lack both sensitivity and specificity. This lack of specificity may have again arisen from the use of pig sera from herds believed to be free from S. suis type 2, which in fact were infected.

The ELISA described here was used to investigate antibodies against S. suis types 1 and 2 in sera from pigs and antibodies to S. suis type 2 in the sera from humans. The ELISA was used to follow levels of antibodies throughout the pig's life and to determine if certain human occupational groups had higher titres than others.

MATERIALS AND METHODS

Antigens

Based on the work of Rote et al (1980), Elder et al (1982) and Logan et al (1982), whole inactivated cells of S. suis were used as antigen for coating the ELISA plates. These workers found that whole

streptococcal cells were superior to the streptococcal carbohydrate polysaccharide in micro-ELISA tests.

Cultures of S. suis types 1 and 2 were grown for 18 hours at 37°C in 50 ml of Todd-Hewitt broth. By making serial dilutions in physiological saline and by the culturing of known volumes on blood agar, the number of S. suis per ml of broth was determined. The broth was centrifuged for 30 minutes at 2000 rpm and the supernatant discarded. The sediment was then suspended in 15 ml of a 0.3% solution of formalin diluted in physiological saline and incubated for 36 hours at 37°C. This produced a formalin inactivated preparation similar to that used for the production of grouping antisera for streptococci (Lancefield, 1938). This preparation was centrifuged for 30 minutes at 2000 rpm and washed three times with PBS. The residue was made up to the initial volume of broth (50 ml) in 0.05 M carbonate-bicarbonate buffer (Appendix III). The antigen was divided into aliquots and stored at either 4°C, if it was to be used within two weeks, or at -20°C for long term storage.

ELISA Technique

Antigen was diluted in ammonium acetate/carbonate buffer (Appendix III) and 100 μ l quantities added to the wells of polystyrene microplates¹. The dilution of antigen was determined by a chequer board titration technique as described later. Two wells had 100 μ l of phosphate buffered saline-Tween (PBS-Tween) (Appendix III) added instead of the antigen, to act as control wells. Plates were incubated overnight at 37°C to allow for the evaporation of the liquid and the adherence of the antigen to the plate. Following incubation plates were rinsed and washed with PBS-Tween. Initially the plates were filled and then emptied by inversion and vigorous shaking. A series of three washes were then performed, using a semiautomatic washer², with wells being filled with 250 μ l of PBS-Tween and emptied by suction. When the plates were filled a third time they were left to stand for three minutes and were then emptied by rapid inversion, shaken dry and the process repeated twice more.

¹ NUNC - Immuno Plate 1, Cat. no. 23454, Intermed, Denmark

² Miniwash Washer Aspirator. Dynatech, Virginia, U.S.A.

Sera were serially diluted in PBS-Tween containing 1% bovine serum albumin¹⁸ (PBS-Tween-BSA) (Appendix III) and 100 μ l aliquots added to microplate wells except for the two control wells which had the same volume of PBS-Tween-BSA added. Initially eight doubling dilutions of sera were used (1 in 50 to 1 in 6400), however to allow more sera to be tested per plate this was reduced to four dilutions (1 in 50 to 1 in 400). The plates were covered and incubated at 37°C for one hour.

The plates were emptied and the wash procedure repeated as described above. The enzyme labelled antiglobulin conjugate (sheep derived anti-pig IgA, IgG, IgM whole molecule peroxidase conjugate¹⁹ or goat derived anti-human IgA, IgG and IgM immunoglobulin peroxidase conjugate²⁰) was diluted in PBS-Tween-BSA and 100 μ l added to all wells except for the control wells which had PBS-Tween-BSA added. The optimum dilution of conjugate used was determined by a chequer board titration technique. Plates were again covered and incubated for one hour at 37°C.

The plates were emptied and the wash procedure repeated. After washing, 100 μ l of citric-phosphate buffer (Appendix III) was added to all wells and plates were left to stand for three minutes. After emptying the buffer, 100 μ l of substrate solution (Appendix III) was added to all wells, and the plates were incubated in the dark for 30 minutes at room temperature. The colourless substrate changed to an orange colour in the presence of peroxidase enzyme. The reaction was stopped by the addition of 100 μ l of a 1 M solution of sulphuric acid and the absorbance measured using a micro-ELISA auto reader²¹. The reader passed two beams of light through each well; the first was at the peak absorbance wavelength of the substrate reaction product (486 nm) and the second at a wavelength (620 nm) at which the substrate product showed no absorbance. The difference between the absorbance for the substrate product and the non-specific background

¹⁸ Immunochemical Product Limited, Auckland, New Zealand

¹⁹ Eivai bios laboratories, Horsham, West Sussex, England

²⁰ Cappel Laboratories Inc., Cochranville P.A. U.S.A.

²¹ SLT 210, SLT Labinstruments Ges. m.b.h. Grodig

absorbance was automatically calculated to provide an accurate measure of the absorbance of the reaction product. The ELISA reader also automatically read the absorbance of control wells, determined the mean absorbance of these two wells and subtracted this value from the absorbance values of all the other wells.

Titration of serum and conjugate

Before the ELISA could be used efficiently the test had to be standardized. Chequer board titrations were performed to determine the optimum concentrations of serum, conjugate and antigen for both the pig and human tests (Voller et al, 1976).

1. ELISA for pig sera

The antigen of S. suis was used at a dilution of 1/16 for the serum/conjugate titration. Four dilutions of conjugate (1/1000, 1/2000, 1/4000 and 1/8000) and seven doubling dilutions of sow serum from 1/50 to 1/3200 were titrated against the bacterial antigens. Control wells without serum or without antigen were also included for all the conjugate dilutions.

2. ELISA for human sera

The antigen of S. suis type 2 was diluted to 1/32 for the chequer board titrations. The conjugate and human serum were used at the same dilutions as for the ELISA on pig sera. The sera from humans was obtained from frozen sera collected for work carried out by Blackmore and Schollum (1982c). The serum selected for the titrations originated from a pig farmer. This serum had been shown to produce a strong ELISA reading in an initial trial to determine if the ELISA would work satisfactorily with human sera.

Determination of optimum antigen concentration

Six doubling dilutions (1/8 to 1/256) of the antigen of both S. suis types 1 and 2 were titrated against four dilutions (1/50, 1/100, 1/200 and 1/400) of sow serum. These same dilutions were maintained for the titrations against human sera. Control wells

lacking antigen or serum were also included. The conjugate dilution was maintained at 1/2000 in both of these tests.

RESULTS

Standardization of Serum and Conjugate

The results from the titration of pig serum against conjugate are shown for S. suis types 1 and 2 in Figures 3.3 and 3.4 respectively. Figure 3.5 shows the titration of human serum against conjugate for S. suis type 2. In all three tests there were weak non-specific reactions at the higher concentrations of sera and conjugate. This was indicated by a slight rise in the absorbance levels of wells containing no antigen when the concentration of serum or conjugate increased. Wells without serum had only minimal absorbance readings.

A dilution of conjugate of 1/1000 produced the highest absorbance readings for both S. suis types 1 and 2 with pig serum as well as for S. suis type 2 with human serum. However, this same dilution also resulted in higher readings of wells containing no antigen (higher non-specific readings). A dilution of 1/2000 reduced both the overall absorbance and the non-specific readings. Weaker dilutions of conjugate, although reducing the non-specific readings, had lower absorbance values.

Determination of Optimum Antigen Concentration

The results of the experiment titrating pig serum against antigen for S. suis types 1 and 2 are shown in Figures 3.6 and 3.7 respectively. At an antigen dilution of 1/8, high absorbance readings were recorded which were close to the upper limit of the apparatus. A dilution of 1/16 produced a good range of absorbance readings at the dilutions of serum used. Weaker dilutions of antigen produced a smaller range of low absorbance readings. Figure 3.8 shows the titration of human serum against the antigen of S. suis type 2. Dilution of antigen to 1/16 also produced absorbance readings close to the maximum levels detectable by the reader. A dilution of 1/32 produced a good range of absorbance readings with more dilute antigen producing a smaller range of weaker readings.

FIGURE 3.3

COMPARISON OF ELISA READINGS AT DIFFERENT DILUTIONS OF PIG SERA AND CONJUGATE AGAINST ANTIGEN OF S. SUIIS TYPE 1 AND "NO-ANTIGEN" CONTROLS

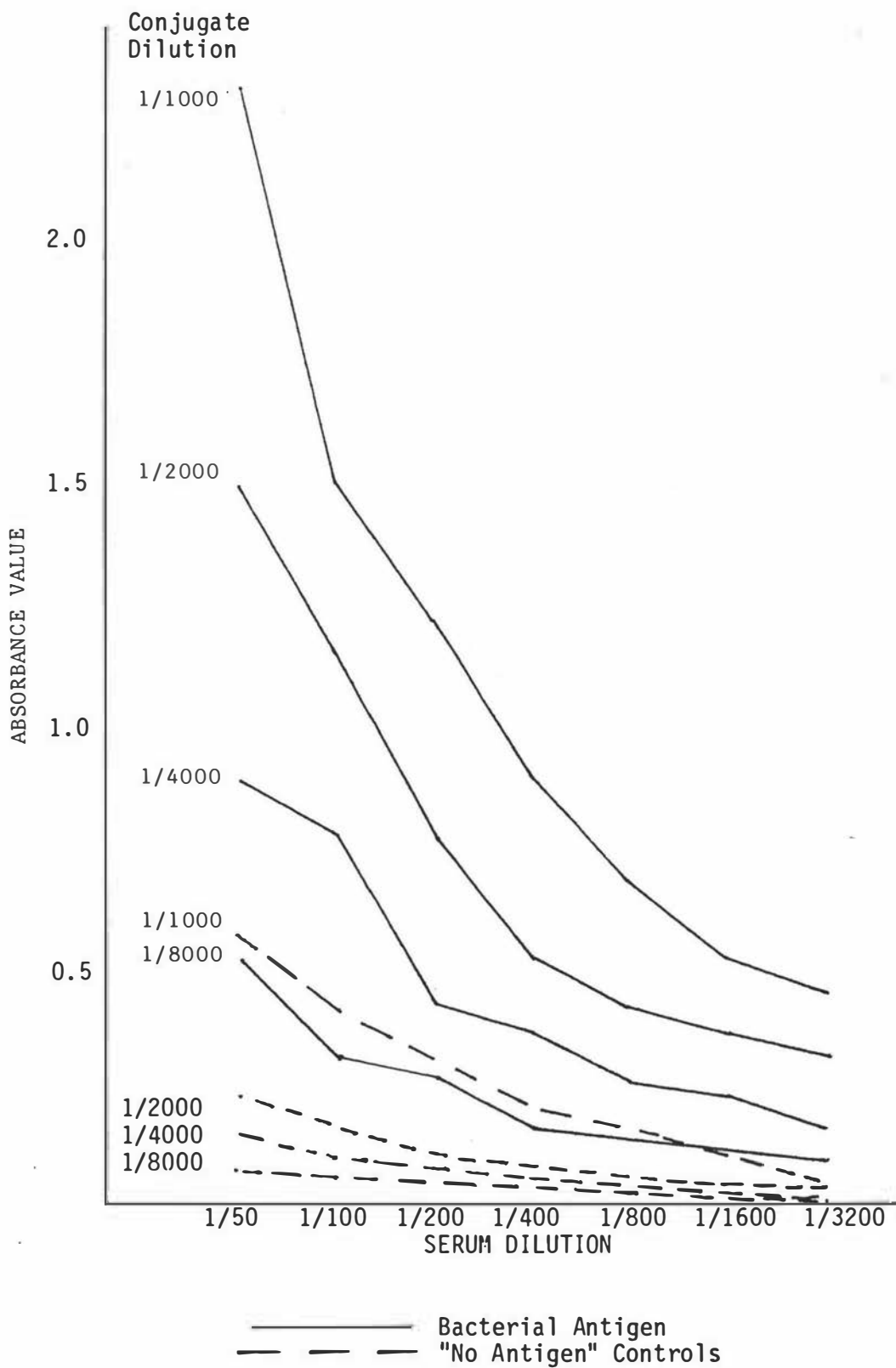

FIGURE 3.4

COMPARISON OF ELISA READINGS AT DIFFERENT DILUTIONS OF PIG SERA AND
CONJUGATE AGAINST ANTIGEN OF S. SUIS TYPE 2
AND "NO-ANTIGEN" CONTROLS

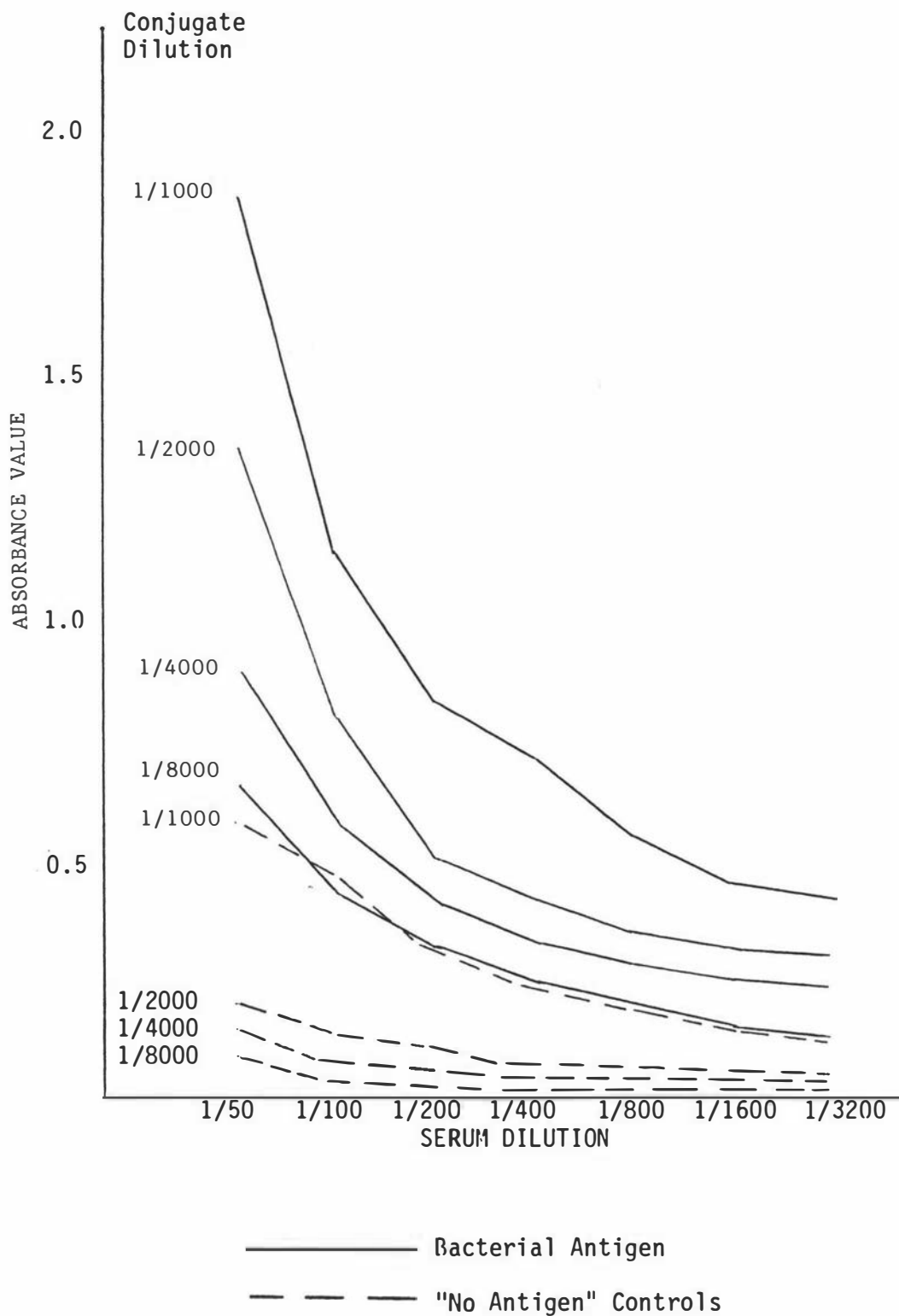
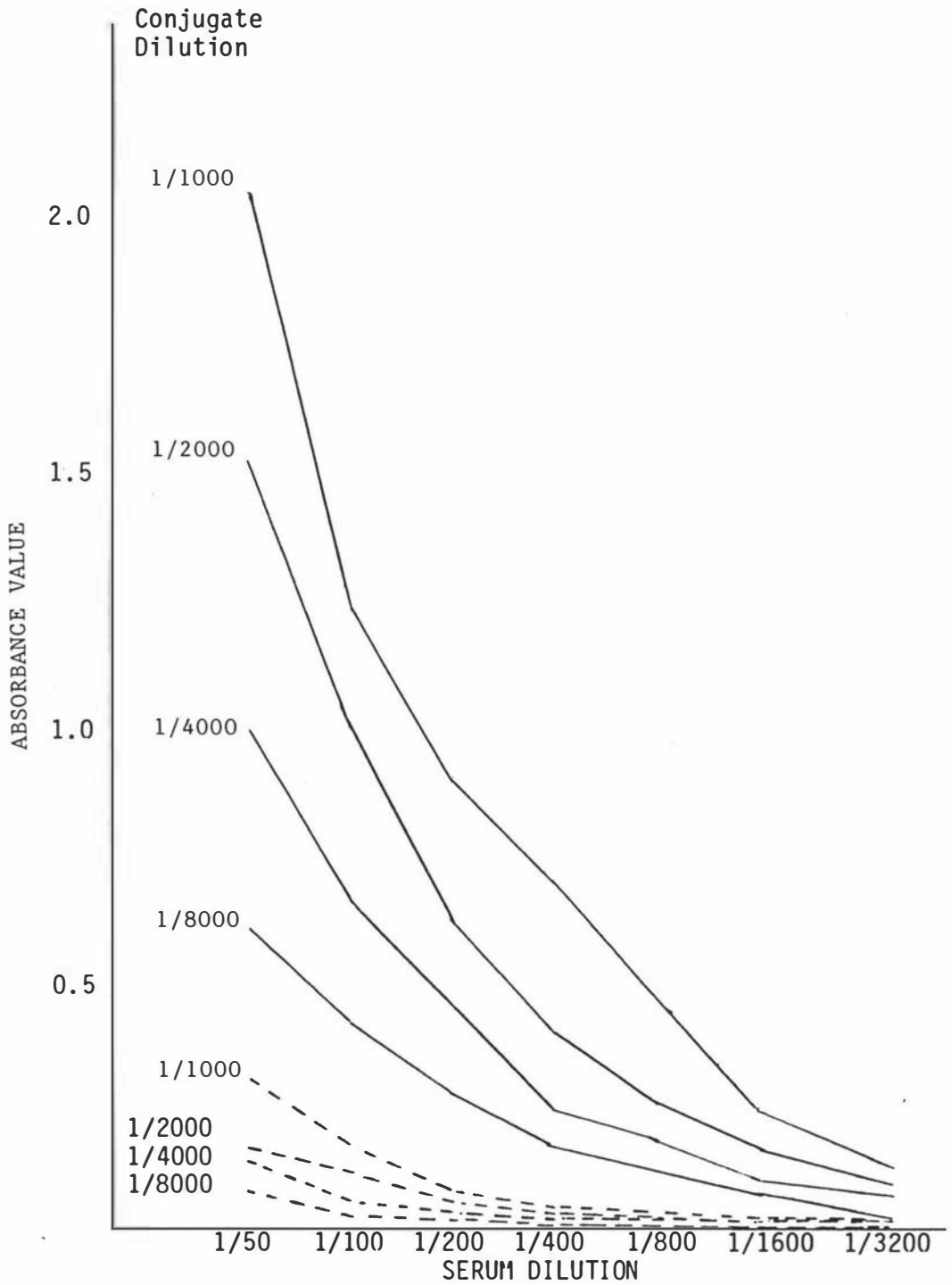

FIGURE 3.5

COMPARISON OF ELISA READINGS AT DIFFERENT DILUTIONS OF HUMAN SERA AND
CONJUGATE AGAINST ANTIGEN OF S. SUIS TYPE 2
AND "NO-ANTIGEN" CONTROLS



———— Bacterial Antigen
 - - - - "No Antigen" Controls

FIGURE 3.6

COMPARISON OF ELISA ACTIVITIES AT DIFFERENT BACTERIAL ANTIGEN
(S. SUIIS TYPE 1) CONCENTRATIONS AGAINST DIFFERENT
PIG SERUM DILUTIONS

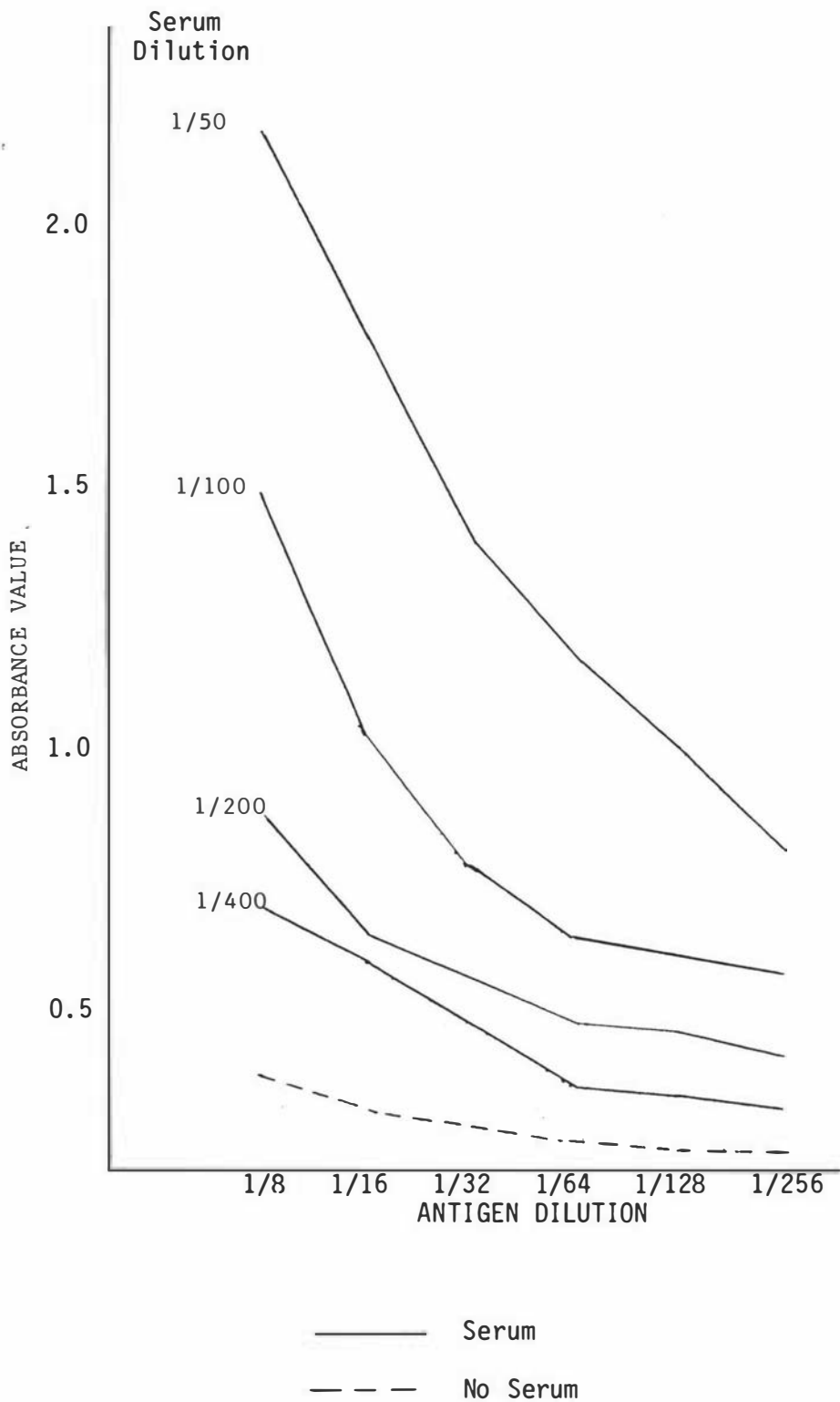

FIGURE 3.7

COMPARISON OF ELISA ACTIVITIES AT DIFFERENT BACTERIAL ANTIGEN
(S. SUIIS TYPE 2) CONCENTRATIONS AGAINST DIFFERENT
PIG SERUM DILUTIONS

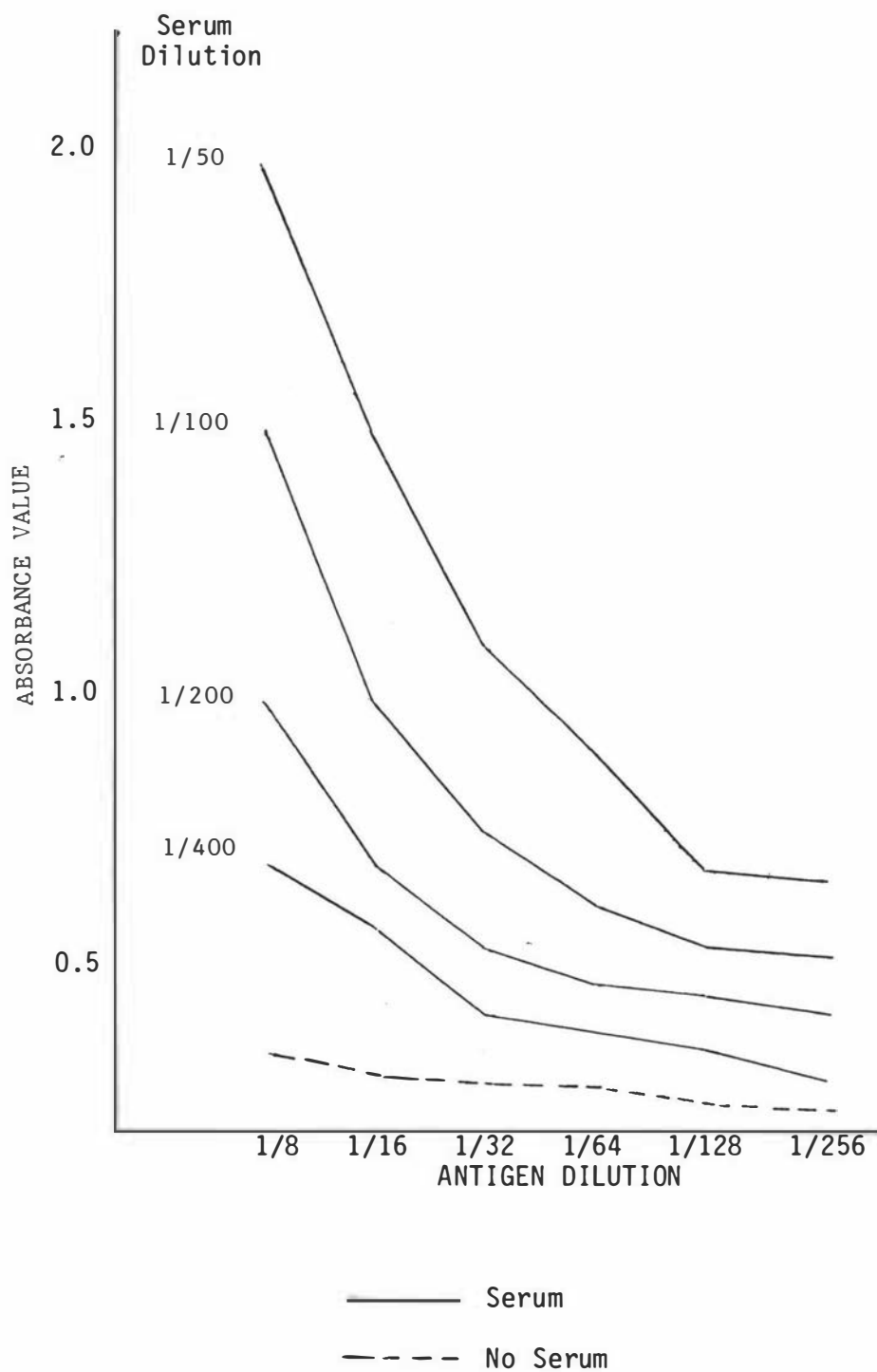
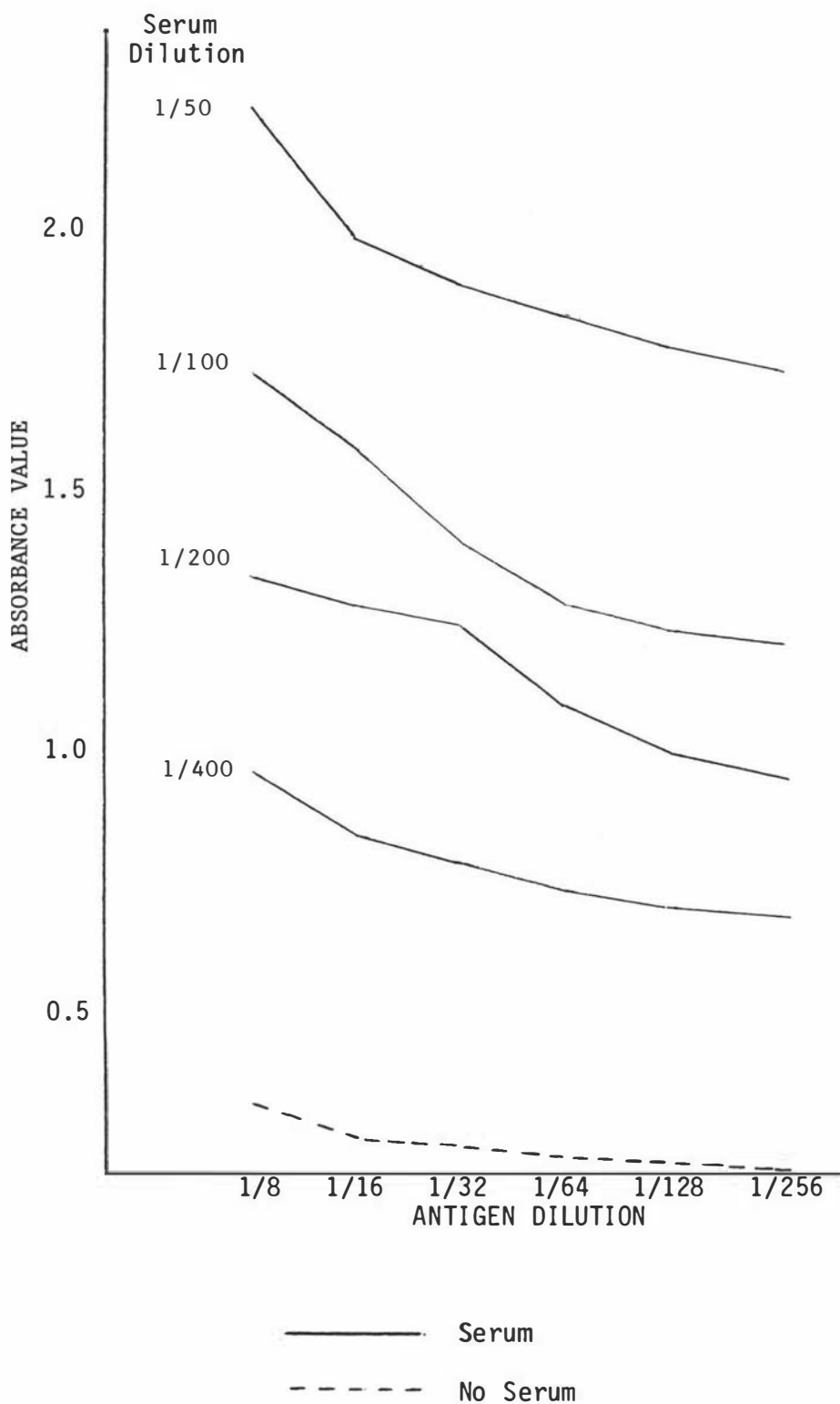

FIGURE 3.8

COMPARISON OF ELISA ACTIVITIES AT DIFFERENT BACTERIAL ANTIGEN
(S. SUIIS TYPE 2) CONCENTRATIONS AGAINST DIFFERENT
HUMAN SERUM DILUTIONS



DISCUSSION

The ELISA developed here detected antibody against S. suis in the sera of both humans and pigs. This test detected the total amount of immunoglobulin present (IgA, IgM and IgG) and did not differentiate between antibody of different classes. As the Micro-ELISA reader will not accurately read wells with absorbance levels greater than two, a conjugate dilution of 1/2000 was selected for both the ELISA for pig and human sera. This dilution of conjugate also reduced the non-specific reactions. An antigen dilution of 1/16 and 1/32 were selected for the ELISA for pig and human sera respectively. These dilutions produced absorbance values within the range detected by the ELISA reader, reduced non-specific reactions and allowed economic use of antigen. Most of the non-specific or background readings originated from the binding of antibody to the ELISA plate rather than from the antigen or conjugate, as wells tested without serum produced only minimal absorbance.

In preliminary work a carbonate-bicarbonate coating buffer was used, however this did not produce absorbance readings as high as those obtained when the volatile ammonium acetate-carbonate buffer developed by Douglas et al (1984) was used. Clifton-Hadley et al (1984b) recorded low absorbance levels in their ELISA for detecting antibodies against S. suis type 2. These low readings could have been associated with the use of carbonate-bicarbonate buffer. In the present test the titration of antigen against serum and conjugate against serum ensured that dilutions of antigen and conjugate were selected which resulted in high absorbance readings without large non-specific reactions.

The specificity of the ELISA could not be determined accurately without the use of serum known to be free from antibodies to S. suis. As discussed earlier, the long duration and rapid spread of infection would ensure all New Zealand pig herds were infected with S. suis. The early age of infection makes it almost impossible to collect sera from pigs not infected with S. suis. Sera collected from newly born piglets is unsuitable for use as negative sera as these piglets have not been exposed to the organisms which may also be causing false positive reactions. In this investigation "no antigen" and "no serum" control wells were used in an attempt to minimize this disadvantage. It is

possible that antibody produced as a result of infection with S. suis, may also be effective against other streptococci or bacterial species and similarly antibody produced as a result of infection with other bacteria may also react with antigens of S. suis. As this test used whole bacterial cells, the possibility of non-specific reactions cannot be ignored. Work described later in this thesis supports the belief that the test was indeed specific.

The ELISA was developed as a tool to investigate the sero-epidemiology of S. suis. This test was designed to compare the antibody levels between groups of pigs or humans and not to specifically quantify the level of antibody in one person or animal. ELISA offers the advantages of being relatively simple to perform, a number of sera can be tested on the one microplate and the quantitative results can be compared.

CHAPTER IV

SURVIVAL OF STREPTOCOCCUS SUIS

INTRODUCTION

The work reported in this chapter is divided into three parts:

- A. the frequency of isolation of S. suis from different sites within a piggery
- B. the duration of survival of S. suis in naturally infected palatine tonsils
- C. the survival of S. suis in the laboratory when maintained under different conditions.

A. SURVIVAL OF S. SUIS IN THE ENVIRONMENT

INTRODUCTION

In the majority of species of animals including man, streptococcal infections are acquired by direct transmission from infected to non-infected animals as occurs with scarlet fever in humans and strangles in horses. However transmission from a contaminated environment can occur. A classic example is that of streptococci associated with bovine mastitis, spread by means of milking machines and other factors associated with poor milking-shed hygiene (Blood et al, 1979). Other routes of transmission including inhalation of airborne droplet nuclei, ingestion of food contaminated with streptococci, or contact with contaminated fomites can also produce outbreaks of streptococcal disease (Deibel, 1977; Quinn, 1977). Streptococci are relatively resistant to environmental factors and can survive in a room for periods of one to two months (Heard, 1984). Although healthy carrier animals would appear to be the main means for spread and maintenance of S. suis in a piggery, S. suis type 2 has been isolated from the environment of a piggery (Clifton-Hadley and Alexander, 1983).

The aim of this section was to investigate if S. suis could be detected in the environment of the piggery and if so the frequency and variability of detection in different areas of the piggery.

MATERIALS AND METHODS

Environmental Swabs

Swabs were taken of the slats and from the solid floors in the farrowing, weaning, growing, fattening and dry sow accommodation areas of one herd (Herd 1 in Chapter V). Dust samples were collected from areas not accessible to the pigs, including light shades, heaters, pen walls and the feed shed. Swabs of the feed, water, feed troughs and effluent were also collected.

Flies from the farrowing and weaning shed were captured alive and the bodies crushed and ground up. Swabs were taken of the crushed flies. All swabs were plated onto sheep blood agar. An I.F.A.T. was performed on the resultant growth as described in Chapter III.

RESULTS

Table 4.1 records the detection of S. suis types 1 and 2 from the environment of the piggery. Streptococcus suis was detected in all sections of the piggery with the highest percentage of positive swabs for both S. suis types 1 and 2 from the weaning house. No S. suis was isolated from the water samples or from 44 dust samples collected throughout the piggery. Both S. suis types 1 and 2 were detected in swabs of the feed troughs sampled from all sections of the piggery. Streptococcus suis was not detected in 25 swabs taken from one room of the weaning house which had been hosed and cleaned out and destocked for two weeks. The growth from 24 swabs of effluent were all negative on the I.F.A.T. for both S. suis types 1 and 2.

The bacterial growth from only one of 38 (2.6%) flies showed positive fluorescence for S. suis type 2. No flies were detected as carrying S. suis type 1.

TABLE 4.1

DETECTION OF S. SUIIS TYPES 1 and 2 BY IMMUNOFLUORESCENCE
FROM THE PIGGERY ENVIRONMENT

| TYPE OF SAMPLE | NUMBER OF SAMPLES TESTED | NUMBER OF SWABS POSITIVE FOR <u>S. SUIIS TYPE 1</u> (%) | NUMBER OF SWABS POSITIVE FOR <u>S. SUIIS TYPE 2</u> (%) |
|------------------------|--------------------------|--|--|
| Farrowing house | | | |
| -mesh floor | 60 | 1 (1.6) | 3 (5.0) |
| -solid floor | 60 | 2 (3.3) | 5 (8.4) |
| -feed troughs | 36 | 2 (5.5) | 3 (8.4) |
| -feed | 15 | 2 (6.6) | 1 (6.6) |
| -water | 5 | 0 (0.0) | 0 (0.0) |
| Weaner House | | | |
| -slats | 35 | 1 (2.8) | 3 (8.5) |
| -solid floor | 35 | 3 (8.5) | 4 (11.4) |
| -feed troughs | 30 | 1 (3.3) | 4 (13.3) |
| -feed | 18 | 0 (0.0) | 1 (5.5) |
| -water | 6 | 0 (0.0) | 0 (0.0) |
| Grower House | | | |
| -solid floor | 64 | 4 (6.2) | 3 (4.6) |
| -feed troughs | 32 | 1 (3.1) | 2 (6.2) |
| -feed | 16 | 0 (0.0) | 1 (3.1) |
| -water | 4 | 0 (0.0) | 0 (0.0) |
| Fattening House | | | |
| -solid floor | 36 | 0 (0.0) | 1 (2.8) |
| -feed troughs | 36 | 1 (2.8) | 1 (2.8) |
| -water | 6 | 0 (0.0) | 0 (0.0) |
| Dry Sow House | | | |
| -slats | 60 | 1 (1.7) | 2 (3.3) |
| -solid floor | 60 | 1 (1.7) | 4 (6.7) |
| -feed troughs | 25 | 1 (4.0) | 2 (8.0) |
| -water | 10 | 0 (0.0) | 0 (0.0) |

DISCUSSION

In this investigation S. suis types 1 and 2 were readily detectable in the environment of the piggery. This is in contrast to the work of others, who have reported difficulty in isolating S. suis from the environment (Clifton-Hadley and Alexander, 1983). The higher proportion detected here may be associated with the use of an I.F.A.T., which is a more sensitive test for identifying S. suis than the traditional microbiological methods.

Clifton-Hadley and Enright (1984) demonstrated that S. suis type 2 could survive for over 100 days in faeces and 54 days in dust kept at 0°C. However it survived for only 8 days in faeces and less than 24 hours in dust at a temperature range of 22° to 25°C, which is the normal operating temperature of most intensive piggeries (Owen, 1982). No S. suis could be detected in dust samples from this piggery, however all samples were collected from areas not accessible to the pigs. Streptococcus suis is dispersed into the air by sneezing, with the production of a droplet greater than 100 μ in size. A droplet of this size has only a short flight range and would not be widely dispersed (Schwabe et al, 1977). It would appear that areas not accessible to the pigs are free from S. suis. However, it is possible that S. suis could be dispersed to these areas with the aerosols generated during hosing and cleaning of pens. If S. suis is present in these areas it is only present in small numbers, less than the minimum required for a positive result on the I.F.A.T. as discussed in the previous chapter. Heard (1984) believed that areas of dust and dirt could harbour S. suis type 2 and initiate infection. He proposed that these areas should be regularly cleaned to minimize the risk of infection. If these areas were not accessible to the pig, there would appear to be little advantage in cleaning these areas in the hope of reducing the numbers of S. suis.

The detection of S. suis type 2 in, or on, flies may provide another means for the spread of infection within or between herds of pigs. Clifton-Hadley et al (1986b) proposed that flies could indirectly spread S. suis type 2 from infected pig carcasses to susceptible pigs, however they did not examine any flies for the presence of infection.

As Clifton-Hadley and Enright (1984) found that S. suis type 2 could survive in faeces, effluent may provide another means for spread of the bacterium between and within herds. Large numbers of flies are also attracted to effluent and could provide another means for the dispersion of infection. The failure to detect S. suis in the effluent in this investigation may be due to

1. a dilution factor from the large volume of water used in this piggery for hosing down, washing and cleaning pens
2. the failure of S. suis to survive in effluent or
3. the complete absence of S. suis in this material.

Although S. suis was detected in all sections of the piggery, the importance of these findings is difficult to determine without accurate knowledge of the minimum infective dose for S. suis. Parker (1978) also isolated group A streptococci from the environment, however these isolates were found to be less infective than those isolated directly from humans.

As S. suis could not be isolated from one room that had been destocked and thoroughly cleaned, it would appear that the main spread of infection of S. suis between and within herds is still likely to be the carrier pig.

CONCLUSIONS

1. Streptococcus suis can be isolated from the environment of the piggery.
2. Streptococcus suis was not detected in dust samples collected from areas not accessible to the pigs.
3. Flies can act as carriers of S. suis type 2.

B. SURVIVAL OF S. SUIS IN THE PORCINE TONSIL

INTRODUCTION

The palatine tonsils are the primary sites for infection of both S. suis types 1 and 2 (Williams et al, 1973; Clifton-Hadley and Alexander, 1980). Clifton-Hadley et al (1984b) found that S. suis type 2 could be carried in the palatine tonsils of normal healthy pigs for over 512 days. These tonsillar carriers were recognized as important in the spread of the organism between pigs and herds. Clifton-Hadley et al (1986b) also showed that S. suis type 2 could survive in the carcasses of slaughtered pigs.

The aim of this experiment was to investigate the duration of survival of S. suis type 2 in the palatine tonsils collected from apparently normal pigs slaughtered at a meatworks.

MATERIALS AND METHODS

Both palatine tonsils, still attached to the tongue and larynx, were collected from apparently healthy pigs slaughtered at a New Zealand meatworks. Palatine tonsils without any ancillary tissue attached were also collected from other pigs at the meatworks. All pigs originated from two herds which were previously shown to be infected with S. suis types 1 and 2. Samples were processed in the laboratory within two hours of collection.

On the day of slaughter one palatine tonsil was incised and swabbed from each sample of the group with the tongue and larynx attached. The swab was plated onto sheep blood agar and an I.F.A.T. performed on the resultant bacterial growth, as described in Chapter III. The tissues, including the tonsils, were maintained at either 4°C or at room temperature (17° to 24°C) for up to eight days. Each day, one palatine tonsil from each sample was incised and a swab taken and handled as above.

On the day of collection, one of the tonsils from each of the paired samples was incised in four parallel planes. Swabs were taken

from each incision and handled as above. The remaining palatine tonsil from each pig was frozen and stored at -20°C . At monthly intervals some of these frozen tonsils were thawed out and incised in four parallel planes. Four swabs were taken from each thawed tonsil and an I.F.A.T. performed on the bacterial growth. The initial percentage of tonsils infected with S. suis was compared with that of tonsils frozen for various periods.

RESULTS

Table 4.2 records the detection of S. suis type 2 from tonsils held at two different temperatures (4°C and room temperature). Streptococcus suis type 2 was detected from some tonsils on every day of sampling. However, the result of the I.F.A.T. on individual tonsils frequently fluctuated between positive and negative. Sampling at room temperature was discontinued after four days due to the strong odour emanating from the decomposing tissue. Tonsils held at 4°C were shown to be infected with S. suis type 2 for at least eight days following slaughter of the pig, and for at least four days when the tonsils were kept at room temperature.

At -20°C , S. suis type 2 were found to survive for at least nine months and S. suis type 1 for six months (Table 4.3). However after four months of storage, the proportion of tonsils producing positive fluorescence was reduced.

DISCUSSION

In this experiment S. suis type 2 survived for at least nine months in frozen palatine tonsils, at least eight days in refrigerated tonsils and for at least four days in tonsils maintained at room temperature. Clifton-Hadley et al (1986b) reported similar results when studying the survival and distribution of S. suis type 2 in pig carcasses following intravenous infection with S. suis type 2. In their experiment, pigs were slaughtered 48 hours after infection. Tissues were maintained at either 4° or 22°C and were routinely cultured for S. suis type 2. Although no S. suis type 2 could be isolated from the muscle, they were identified in the liver and

TABLE 4.2

DETECTION (%) OF S.SUIS TYPE 2 BY I.F.A.T. FROM PALATINE TONSILS
STORED AT 4°C and ROOM TEMPERATURE

| STORAGE TEMPERATURE | NUMBER OF TONSILS SAMPLED | DAY OF SAMPLING POST-SLAUGHTER | | | | | | | | |
|------------------------|---------------------------------|--------------------------------|-----------|-------------|------------|-------------|-----------|-------------|-----------|-------------|
| | | 0 | 1 | 2 | 3 | 4 | 5 | 6 | 7 | 8 |
| 4°C | 8 | 7 (87.5) | 6 (75) | 6 (75) | 8 (100) | 5 (62.5) | 6 (75) | 5 (62.5) | 4 (50) | 5 (62.5) |
| 22°C | 6 | 4 (66.7) | 3 (50) | 2 (33.3) | 3 (50) | 2 (33.3) | - | - | - | - |

- not sampled

TABLE 4.3

DETECTION (%) OF S. SUIS TYPES 1 and 2 BY I.F.A.T.
FROM PALATINE TONSILS STORED AT -20°C

| | SLAUGHTER | TIME OF SAMPLING (MONTHS) | | | | |
|--------------------------|-----------------|---------------------------|---------------|---------------|---------------|---------------|
| | | 1 | 2 | 4 | 6 | 9 |
| <u>S. suis</u> type 1 | 22/40 (55) | 4/8 (50) | 3/8 (37.5) | 3/8 (37.5) | 1/8 (12.5) | 0/8 (0.0) |
| <u>S. suis</u> type 2 | 31/40 (77.5) | 6/8 (75) | 5/8 (62.5) | 6/8 (75) | 3/8 (37.5) | 1/8 (12.5) |

joints. When these "infected" tissues were maintained at 4°C, S. suis type 2 was isolated for six weeks after slaughter and for at least 12 days when the tonsils were maintained at 22°C. They believed that because of this long period of survival, carcasses infected with S. suis type 2 could still be a health hazard long after slaughter. The findings of Kloppenburg et al (1975), who reported a case of meningitis from S. suis type 2 in a female butcher after an injury from a pork bone, supports this hypothesis. Clifton-Hadley et al (1986b) believed that carcasses of pigs, which had died as a result of infection with S. suis type 2, could be a source of indirect spread of infection. They believed that if these carcasses were left unburied, infection could be spread via birds, rats, mice, flies or dogs. Cannibalism, which is a problem in some pig herds (Hanbury et al, 1986), and the ability of S. suis type 2 to survive in infected carcasses could provide another means for spread of the disease within herds.

Streptococcus suis type 1 was also shown to survive for up to six months in frozen tonsils. Although S. suis type 1 is not a known zoonotic agent (Clements et al, 1982), infected carcasses could allow the spread of disease in a similar way to that discussed for S. suis type 2.

The finding that S. suis could survive in frozen and refrigerated tissues has other important implications. It indicates that samples can be collected and kept frozen without reducing the sensitivity of the I.F.A.T. This ability to survive at low temperatures was utilized in Chapter V, by sampling pigs from different regions in New Zealand and returning these samples either chilled or frozen to the microbiological laboratory.

In individual palatine tonsils maintained at 4°C, fluctuations occurred in the results obtained from the I.F.A.T. These fluctuations could be explained by the sensitivity of the I.F.A.T., as described in the previous chapter, and not by a variation in the actual number of organisms present within the tonsil.

CONCLUSIONS

1. Streptococcus suis type 2 survived for at least eight days in palatine tonsils maintained at 4°C and for four days in tonsils kept at 22°C.
2. Streptococcus suis type 1 survived for at least six months and S. suis type 2 for nine months at -20°C.

C. SURVIVAL OF S. SUIS UNDER DIFFERENT CONDITIONS IN THE LABORATORY

INTRODUCTION

Although S. suis is considered relatively resistant to general environmental factors (Heard, 1984), little work has been done on the influence of specific factors such as pH, temperature, dessication, osmolarity and the effects of disinfectants on the survival of this bacterium. The aim of this section was to investigate these factors in the attempt to understand their effect on the survival of S. suis within the piggery.

MATERIALS AND METHODS

Strains of S. suis

In these experiments type cultures for S. suis types 1 and 2 (NCTC 10234 and NCTC 10237 respectively) and field isolates of both types collected from healthy tonsillar carriers were used. Pure cultures of S. suis were inoculated into Todd Hewitt Broth and incubated for 18 hours at 37°C prior to experimentation.

Enumeration of S. suis

To investigate the pattern of survival of S. suis, the number of organisms at the start of each experiment and at various intervals

during the experiment was calculated. This was done by taking 0.5 ml of the test solution containing S. suis and doing a series of ten fold dilutions in physiological saline. At each dilution, 0.1 ml was spread over sheep blood agar plates. These plates were incubated for 18 hours at 37°C and the number of colonies on each plate counted. The number of S. suis present in the initial solution was calculated from the average number of colonies on each plate and the degree of dilution.

Organic Matter

Yeast was initially used to simulate the presence of organic matter in some test solutions. Although this was a standardized material, it was unsatisfactory as it provided nutrients for bacterial multiplication. Subsequently faeces were used as organic matter. Faeces were collected from sows and grower pigs from one intensive piggery, the pH measured, and a composite mixture autoclaved at 121°C for 15 minutes.

pH

The influence of pH on the survival of field strains of S. suis types 1 and 2 was studied by inoculating S. suis into seven buffered solutions with a range of pH from 5 to 10.6. Two citric-phosphate buffer solutions were made at a pH of 5.0 and 6.4; three phosphate buffer solutions were made with a pH of 6.4, 7.4 and 8.0 and two carbonate-bicarbonate buffer solutions made with a pH of 9.2 and 10.6 (Appendix IV). A known number of S. suis in 0.25 ml of broth were inoculated into 4.75 ml of each buffer and the solution maintained at room temperature. Three hours after mixing, and then at 24 hour intervals for up to 13 days, samples were taken from each solution and the number of viable S. suis calculated. Duplicate solutions incorporating 5% autoclaved faeces were also tested.

Temperature

A known number of S. suis suspended in 0.25 ml of broth were added to 4.75 ml of physiological saline. These solutions were maintained at approximately -20°C (freezer compartment of the refrigerator), approximately 4°C (refrigerator), 17° to 24°C (room temperature), 37°C, 45°C and 60°C. Three hours after inoculation and

then at daily, weekly and two-weekly intervals for up to 15 weeks, 0.5 ml of the solution was collected, diluted in physiological saline and the number of viable S. suis determined as described above. With the samples maintained at -20°C a new bottle was thawed and used at each time of testing. The solution maintained at 60°C was sampled every minute for the first ten minutes. The susceptibility to temperature was tested for all four isolates of S. suis and also duplicated in physiological saline incorporating 5% sterilized pig faeces.

Saline concentration

The effect of saline concentration on the survival of strains of S. suis was studied by subjecting these bacteria to seven solutions of differing concentration of sodium chloride. A known number of S. suis organisms were added to solutions made up from distilled water, 0.1%, 0.9%, 2.5%, 6.5%, 10%, and 20% saline solutions. All solutions were maintained at room temperature and sampled as described above. These experiments were repeated incorporating 5% yeast in the solutions.

Dessication

A known number of S. suis were diluted in physiological saline and 0.1 ml dispensed onto sterile microscope cover-slips. These cover-slips were kept in sterile petri dishes and the solution allowed to dry out. At weekly intervals, cover slips were taken and dropped into a known volume of physiological saline, shaken vigorously and the number of viable S. suis determined as described earlier. Due to the difficulty in removing all organisms from the cover slip this technique was discontinued and replaced with a swabbing technique. A drop of physiological saline was dispensed onto cover slips containing the drop of desiccated culture. They were swabbed vigorously and the swab plated onto sheep blood agar. Although this method could not allow for enumeration of viable S. suis, it did provide a yes/no survival indicator. Samples were initially taken daily, then weekly, and then two-weekly for up to 12 weeks. All cover slips were maintained at room temperature. The experiment was duplicated with the incorporation of 5% autoclaved faeces in the solution dispensed onto the cover slips.

Disinfectants

The effect of disinfectants on the survival of S. suis was assessed by means of a capacity-use dilution test as described by Kelsey et al (1965) and Kelsey and Sykes (1969). The disinfectants were diluted to the manufacturers specification in either a sterile solution of distilled water or a sterile solution of distilled water incorporating 5% yeast¹. The S. suis to be tested was incubated in Todd Hewitt Broth for 18 hours at 37°C. Twelve ml of the diluted disinfectant mixture was dispensed into a sterile universal bottle and at ten minute intervals, two ml of broth was added to the disinfectant and the mixture thoroughly shaken. Eight minutes after the broth was added, five drops of the mixture were placed on a sheep blood agar plate. The test continued for one hour which allowed for the addition of six volumes of organisms and a halving in the initial concentration of disinfectant. The agar plates were incubated at 37°C for 18 hours and the number of drops with positive growth counted. The end point for the disinfectant was taken to be the highest number of broth additions that gave less than five colonies from the five drops.

To calculate the minimum inhibitory concentration of some disinfectants, doubling dilutions of the disinfectants were made in volumes of 5 ml of Todd Hewitt Broth. These were each inoculated with 0.02 ml of a one in ten dilution of an overnight broth culture of S. suis. The solution was then incubated at 37°C for 24 hours and examined for the presence of bacterial growth.

RESULTS

pH

Figures 4.1 and 4.3 compare the survival of field isolates of S. suis types 2 and 1 respectively in solutions of different pH. In Figures 4.2 and 4.4, the inactivation of field isolates of S. suis types 2 and 1 respectively are shown for solutions of different pH with 5% faeces added. These figures are redrawn in Figures 1 to 7 (Appendix V) to compare the time of survival of isolates in each of

¹ DYC Active Yeast, DYC Foods, Auckland, New Zealand

FIGURE 4.1

THE EFFECT OF pH SOLUTIONS ON THE SURVIVAL OF A FIELD ISOLATE OF S. SUIIS TYPE 2

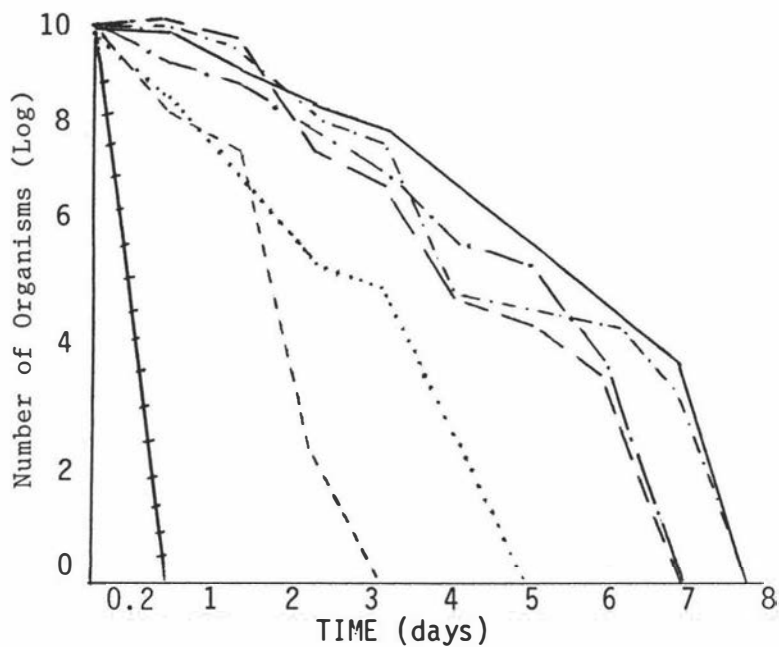
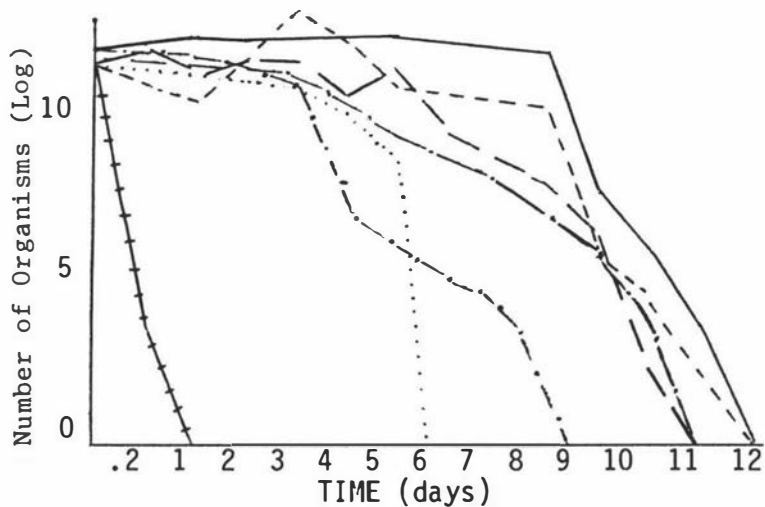

FIGURE 4.2

THE EFFECT OF pH SOLUTIONS WITH 5% FAECES ON THE SURVIVAL OF A FIELD ISOLATE OF S. SUIIS TYPE 2



- | | | |
|-------------|------------------------------|---------|
| | Citrate-phosphate buffer | pH 5.0 |
| — — — — | Citrate-phosphate buffer | pH 6.4 |
| - . - . - . | Phosphate buffer | pH 6.4 |
| — — — — | Phosphate buffer | pH 7.4 |
| — . — . — . | Phosphate buffer | pH 8.0 |
| - - - - - | Carbonate-bicarbonate buffer | pH 9.2 |
| + + + + + | Carbonate-bicarbonate buffer | pH 10.6 |

FIGURE 4.3

THE EFFECT OF pH SOLUTIONS ON THE SURVIVAL OF A FIELD ISOLATE OF S. SUIIS TYPE 1

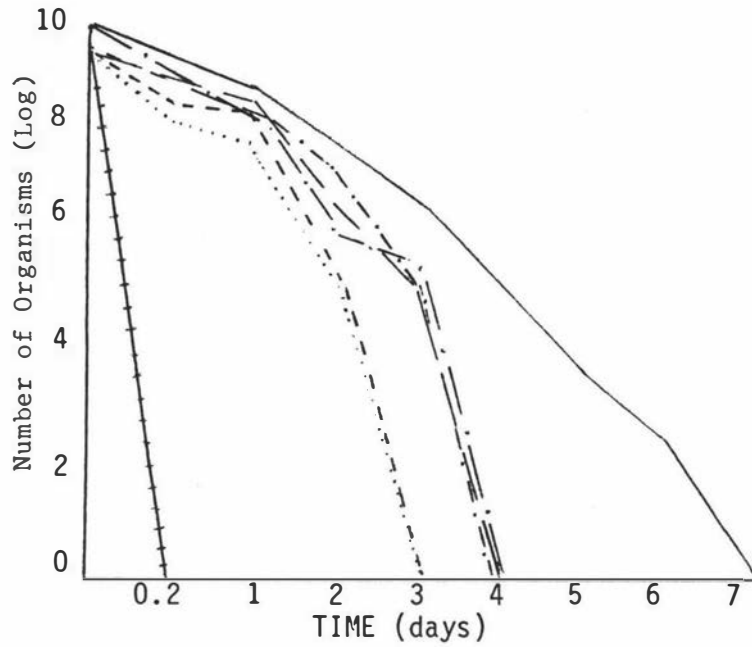
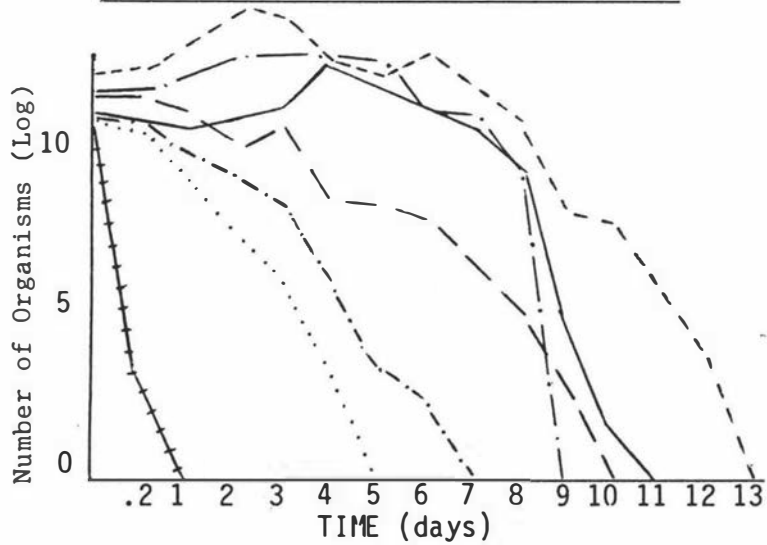

FIGURE 4.4

THE EFFECT OF pH SOLUTIONS WITH 5% FAECES ON THE SURVIVAL OF A FIELD ISOLATE OF S. SUIIS TYPE 1



- Citrate-phosphate buffer pH 5.0
- Citrate-phosphate buffer pH 6.4
- - - - - Phosphate buffer pH 6.4
- Phosphate buffer pH 7.4
- . - . - Phosphate buffer pH 8.0
- - - - - Carbonate-bicarbonate buffer pH 9.2
- + + + + + Carbonate-bicarbonate buffer pH 10.6

the buffered solutions. Streptococcus suis survived for up to two weeks in a range of solutions (pH 5 to 9.2). In solutions without faeces, the field isolates survived for the longest time in the phosphate buffered solution of pH 7.4 (seven and eight days for S. suis types 1 and 2 respectively). Streptococcus suis type 2 also survived for eight days in the phosphate buffered solution with a pH of 6.4. In solutions with pH's greater than 9.2, S. suis types 1 and 2 were inactivated within three days. The fastest inactivation of both S. suis types 1 and 2 occurred in the most alkaline solution (carbonate-bicarbonate solution, pH 10.6), with all organisms being inactivated within four hours. The two buffered solutions at the same pH of 6.4 (citrate phosphate buffer and phosphate buffer) inactivated S. suis within similar periods (seven and eight days with S. suis type 2 and four days with S. suis type 1). When faeces were added to the buffered solutions, the period of survival for both S. suis types 1 and 2 was increased in all solutions. S. suis type 1 survived for the longest (13 days) in a carbonate-bicarbonate solution (pH 9.2) whilst S. suis type 2 survived for 12 days in both the carbonate-bicarbonate solution (pH 9.2) and phosphate buffered solution (pH 7.4). When faeces were present, the carbonate-bicarbonate buffer (pH 10.6) still produced the most rapid inactivation of organisms. In solutions without faeces, there was a steady decrease in the number of viable organisms over the period of the experiment. However in solutions incorporating faeces, other than the strongly acidic or alkaline ones, the number of organisms did not start decreasing until up to eight days after the start of the experiment.

Temperature

The number of S. suis type 2 (field strain and type culture) surviving in physiological saline maintained at various temperatures is shown in Figures 4.5 and 4.6, and for S. suis type 1 in Figures 4.7 and 4.8. The effect of faeces on the survival of S. suis types 2 and 1 is shown in Figures 4.9 and 4.10 respectively. In Appendix V (Figures 8 to 13) the survival of the different types of S. suis are compared at each temperature. Both S. suis types 1 and 2 survived for the longest periods when maintained at -20°C (S. suis type 1 survived for 77 days in physiological saline and at least 105 days in physiological saline with 5% faeces, and S. suis type 2 survived for 91 days in

FIGURE 4.5

THE EFFECT OF TEMPERATURE ON THE SURVIVAL OF A FIELD ISOLATE
OF S. SUIS TYPE 2 IN PHYSIOLOGICAL SALINE

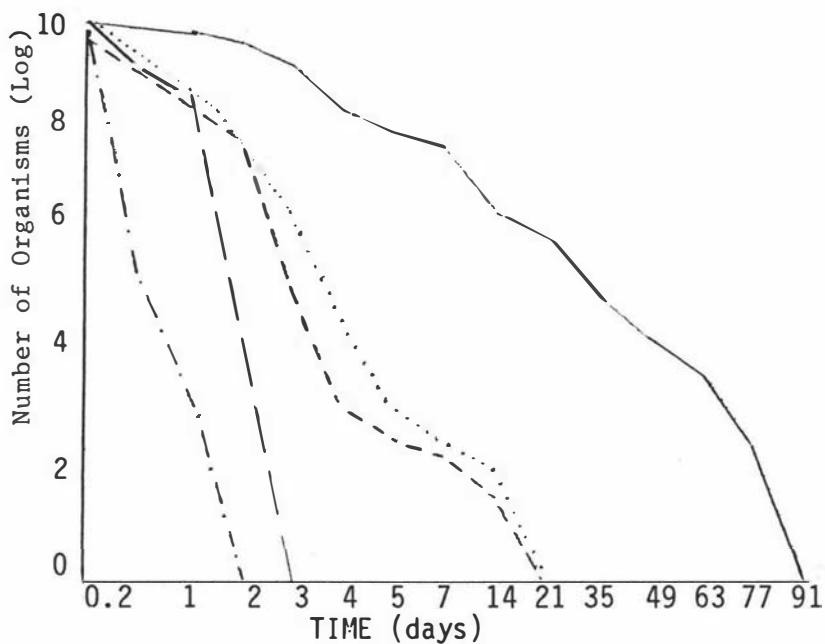
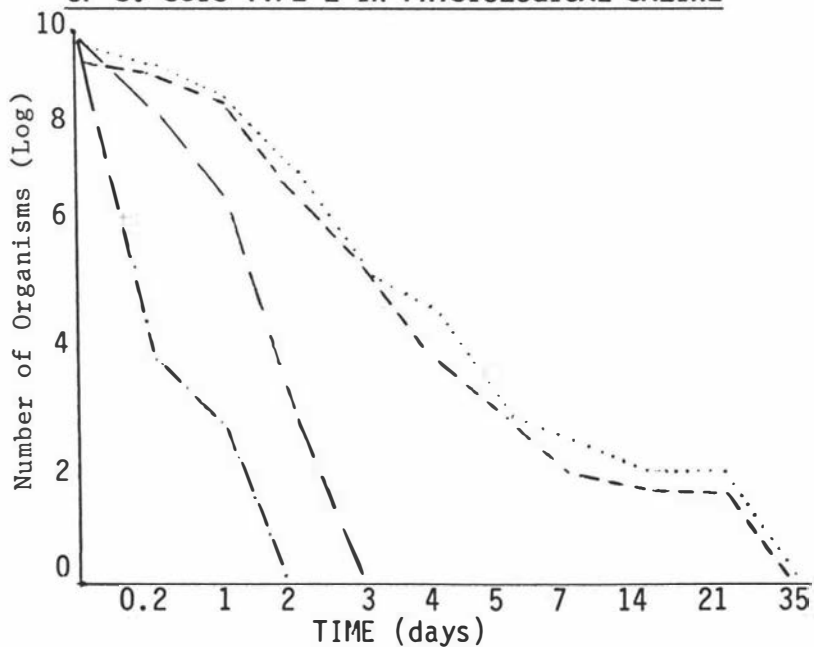

FIGURE 4.6

THE EFFECT OF TEMPERATURE ON THE SURVIVAL OF A STRAIN CULTURE
OF S. SUIS TYPE 2 IN PHYSIOLOGICAL SALINE



- - - - - 45°C
 ———— 37°C
 - · - · - Room Temperature (17° to 24°C)
 ······ 4°C
 ———— -20°C

FIGURE 4.7

THE EFFECT OF TEMPERATURE ON THE SURVIVAL OF A FIELD ISOLATE
OF S. SUIIS TYPE 1 IN PHYSIOLOGICAL SALINE

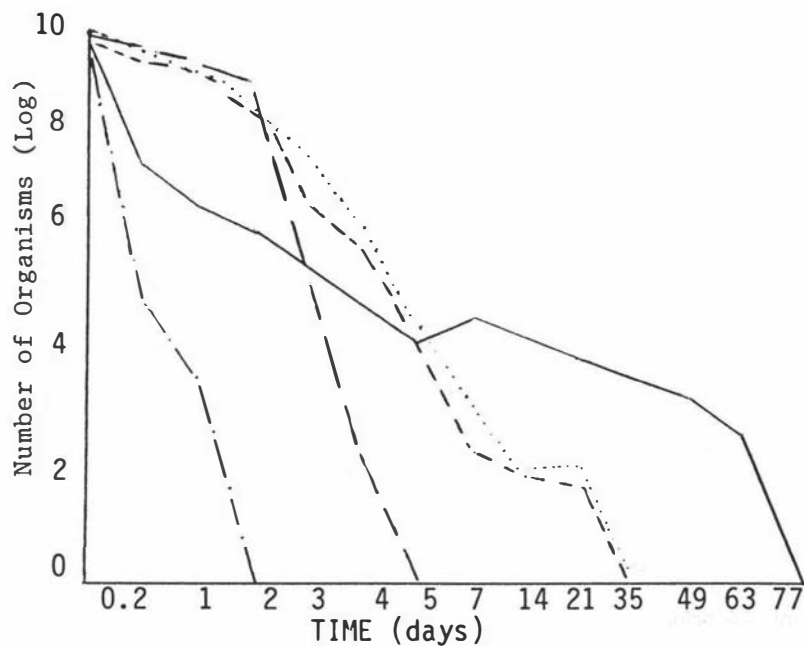

FIGURE 4.8

THE EFFECT OF TEMPERATURE ON THE SURVIVAL OF A STRAIN CULTURE
OF S. SUIIS TYPE 1 IN PHYSIOLOGICAL SALINE

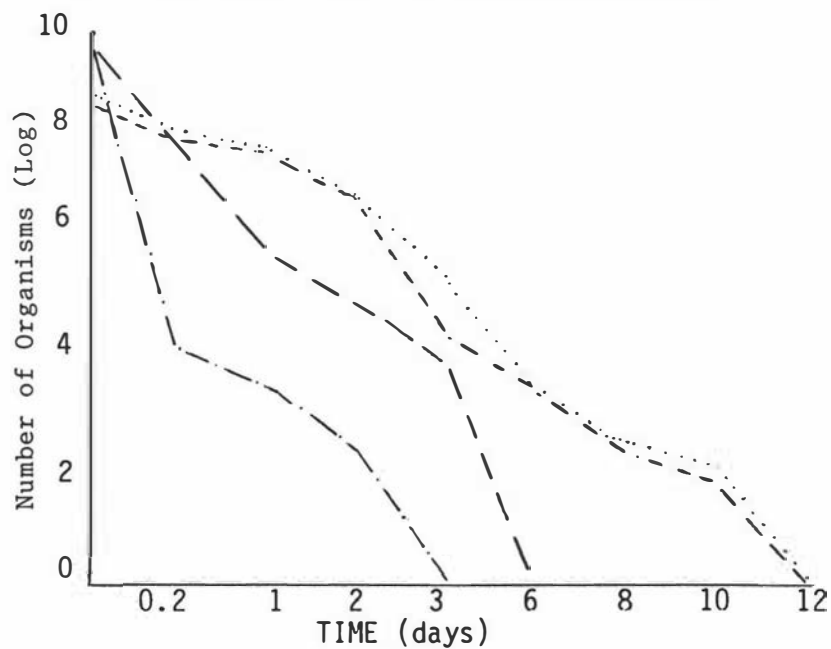

FIGURE 4.9

THE EFFECT OF TEMPERATURE ON THE SURVIVAL OF S. SUIIS TYPE 2
IN PHYSIOLOGICAL SALINE WITH 5% FAECES

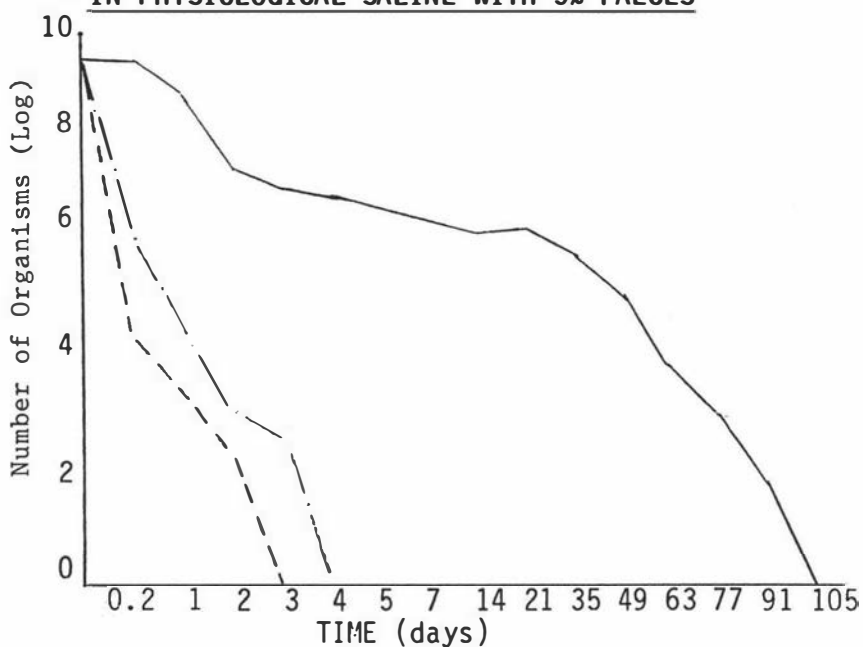
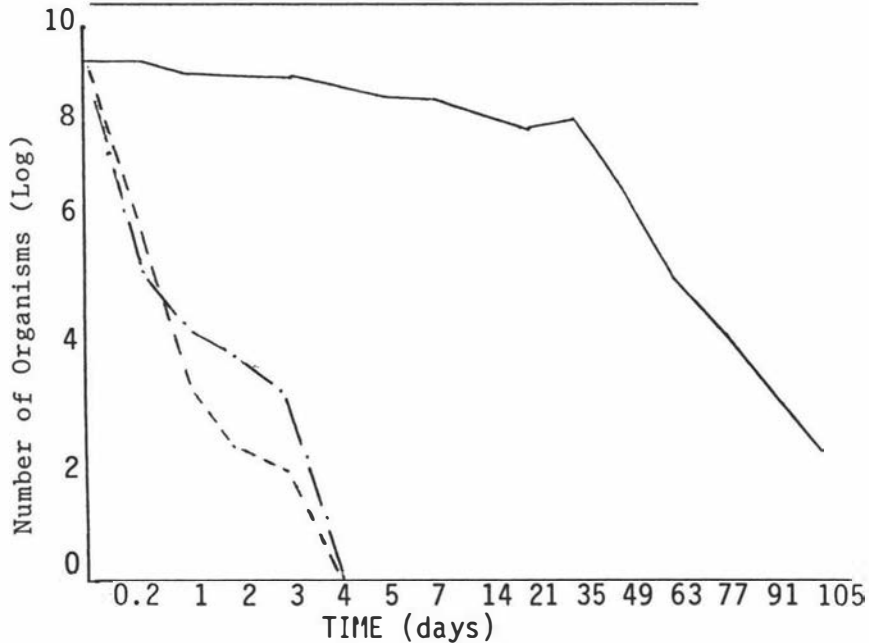

FIGURE 4.10

THE EFFECT OF TEMPERATURE ON THE SURVIVAL OF S. SUIIS TYPE 1
IN PHYSIOLOGICAL SALINE WITH 5% FAECES



- . - . - 45°C (Field Strain)
 - - - - - 45°C (Strain Culture)
 - - - - - -20°C

physiological saline and 105 days in physiological saline with 5% faeces). As the temperature of the maintenance solution was increased, the duration of survival was reduced for both S. suis types 1 and 2. However, for samples maintained at either 4°C or at room temperature (17 to 24°C) the periods of survival, and hence the rate of inactivation of organisms were almost identical. At room temperature, 37°C and 45°C there were only one or two days difference between the survival of the field isolates of both S. suis types 1 and 2 when compared with the type strains of these organisms. However at 4°C, the field isolate of S. suis type 1 survived for 28 days longer than the type culture, whilst for S. suis type 2 the type culture survived 14 days longer than the field isolate. When cultures were maintained at 60°C (Figure 13 - Appendix V) all organisms were destroyed within two minutes. Most organisms were inactivated within the first minute at this temperature. The addition of faeces to the culture did not extend the survival time at 60°C, however at all other temperatures the duration of survival was increased.

Saline Concentration

Figures 4.11 and 4.12 compare the survival of S. suis type 2 in seven different saline solutions with and without 5% yeast. Similarly, Figures 4.13 and 4.14 compare the survival of S. suis type 1 in these solutions with and without 5% yeast. These figures are also redrawn in Appendix V (Figures 14 to 20) to compare the different types of S. suis and the effect of yeast in each of the saline solutions. Both S. suis types 1 and 2 survived for the longest period in physiological saline (0.9% saline). Streptococcus suis type 1 survived for eight days in 0.9% saline and 16 days when yeast was added, whilst S. suis type 2 survived for seven and 20 days respectively. The addition of yeast enhanced the period of survival for both S. suis types 1 and 2 in all saline solutions. In solutions without yeast and of high salt concentration (20% and 10%), there was rapid destruction of both S. suis types 1 and 2. All organisms were inactivated after one day in these solutions. The addition of yeast to these solutions enhanced the period of survival for S. suis. Streptococcus suis type 2 then survived for five days in 10% saline and three days in the 20% solution, whilst S. suis type 1 survived for three days in both solutions. In a solution with a saline concentration of 6.5% and

FIGURE 4.11

THE EFFECT OF SALINE SOLUTIONS ON THE SURVIVAL OF A FIELD ISOLATE OF S. SUIIS TYPE 2

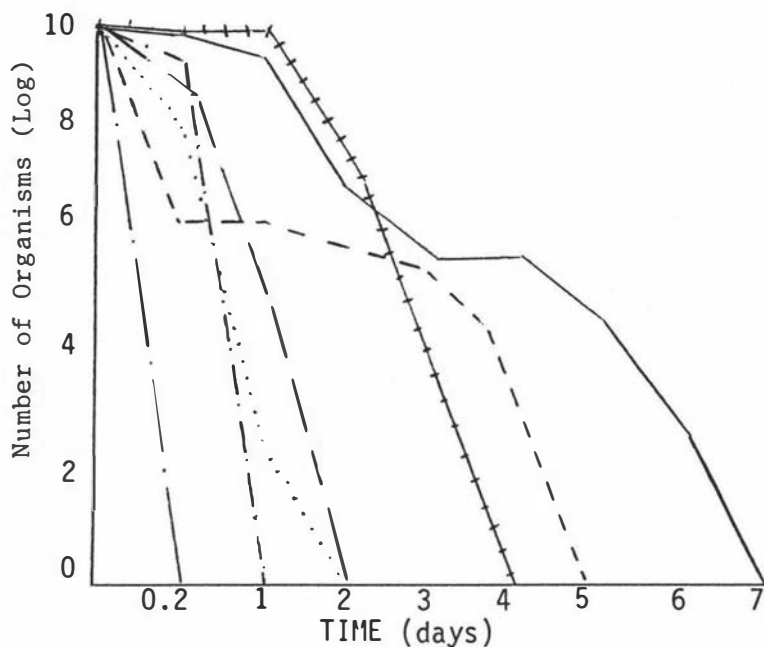
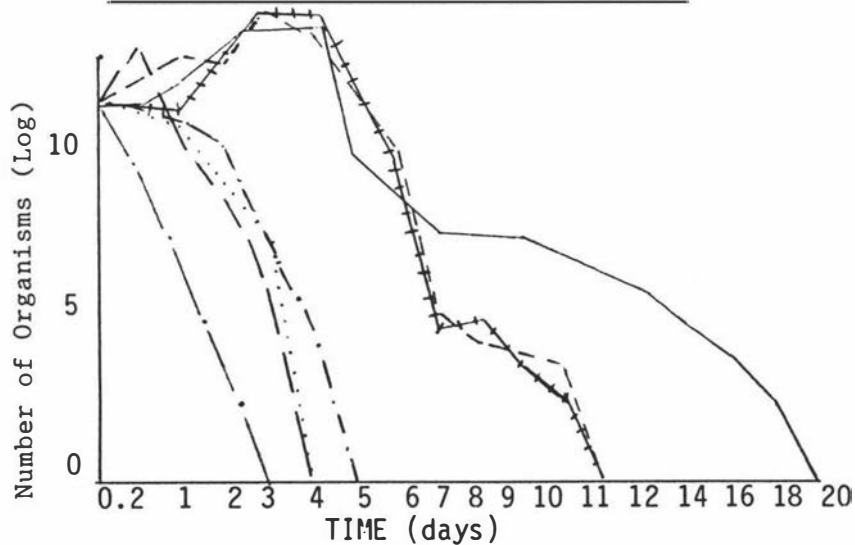

FIGURE 4.12

THE EFFECT OF SALINE SOLUTIONS WITH 5% YEAST ON THE SURVIVAL OF A FIELD ISOLATE OF S. SUIIS TYPE 2



- · — · — · — · — 20% Sodium Chloride solution
- - - - - 10% Sodium Chloride solution
- · · · · 6.5% Sodium Chloride solution
- - - - - 2.5% Sodium Chloride solution
- — — — — 0.9% Sodium Chloride solution
- + + + + + 0.1% Sodium Chloride solution
- - - - - 0.0% Sodium Chloride solution

incorporating 5% yeast (Figure 4.14), the numbers of S. suis type 1 actually increased before reducing after six days. This temporary increase in the number of organisms also occurred for all isolates suspended in solutions of yeast with a saline concentration less than 6.5%.

Dessication

Streptococcus suis type 1 survived for four weeks and S. suis type 2 for six weeks when solutions of these bacteria were dried on sterile microscope cover slips. When faeces were added to the initial bacterial solution, the survival time was increased to eight and ten weeks for S. suis types 1 and 2 respectively.

Disinfectants

The results of the capacity-use test for disinfectants are listed in Table 4.4. Savlon and Multikleen at the high concentration (5%) showed good disinfecting abilities whilst Medol and Multikleen at the low concentration (2.5%) had poor disinfecting qualities for S. suis. The disinfecting ability was judged by the criterion of Kelsey et al (1965) who regarded a disinfectant as "satisfactory" if three or more volumes of bacterial broth could be added before a positive culture was obtained. The high concentration of Multikleen was that recommended by the manufacturer for use when organic matter was present. The addition of 5% yeast, to simulate the presence of organic matter, decreased the effectiveness of both the more concentrated solutions of Multikleen and Savlon for both S. suis types 1 and 2. There was no effect on the weak solutions of Multikleen or Medol, which had failed to inhibit growth even at the first introduction of organisms.

The minimum inhibitory concentrations of Medol and Multikleen for S. suis were greater than 1/1600 and 1/640 respectively. These dilutions were far in excess of the manufacturers dilution instructions.

TABLE 4.4

CAPACITY-USE DISINFECTANT TEST RESULTS FOR S. SUIS
INCORPORATING 5% YEAST

| DISINFECTANT | MANUFACTURERS RECOMMENDED CONCENTRATION OF DISINFECTANT (%) | HIGHEST DISINFECTANT CONCENTRATION GIVING LESS THAN 5 COLONIES | | | |
|----------------------|--|---|--|--------------------------|--|
| | | <u>S. suis</u> type 1 | <u>S. suis</u> type 1 (5% yeast) | <u>S. suis</u> type 2 | <u>S. suis</u> type 2 (5% yeast) |
| Potassium Hydroxide* | 2.5 | 2.5 (1) | 2.5 (1) | 2.5 (1) | 2.5 (1) |
| Potassium Hydroxide* | 5.0 | 2.5 (6) | 2.7 (5) | 2.5 (6) | 2.7 (5) |
| Synthetic Phenol+ | 1.0 | 1.0 (1) | 1.0 (1) | 1.0 (1) | 1.0 (1) |
| Cetrimide# | 2.5 | 1.25 (6) | 1.25 (6) | 1.25 (6) | 1.25 (6) |

() - number of broth increments

* - Multikleen, KW Products Ltd., Auckland

+ - Medol, GIBCO N.Z. Ltd., Auckland

- Savlon, ICI Tasman, ICI N.Z. Ltd, Upper Hutt.

DISCUSSION

Microorganisms are susceptible to changes in the acidity or alkalinity of their surrounding media and a suitable environmental pH is essential for microbial metabolism and growth (Cruickshank et al, 1975). Streptococcus suis was shown to survive in solutions with a wide range of pH, with greatest longevity in slightly alkaline solutions. These findings support those of Cruickshank et al (1973) who demonstrated that most bacteria grow best in a slightly alkaline medium. Wessman (1986) reported that group E streptococci of pigs were also fairly resistant to acidic conditions. Talkington et al (1981) studied the survival of various Gram positive organisms in a fermentation process and found that group E streptococci survived and actually increased in numbers whilst all other Gram positive organisms were inactivated or reduced in numbers during the process. The group E streptococci survived at pH's of between 4 and 5 during the process. In the present investigation S. suis was also found to be relatively resistant to destruction in an acidic medium, surviving for up to six days at a pH of 5.0 in a buffered solution containing faeces. The pH of fresh and autoclaved faecal samples, collected from a piggery, varied from 6.3 to 6.9. In a solution at this pH, S. suis was shown to survive for at least one week. However the effect of other viable bacteria, which would normally be present in the faeces, was not investigated. The rapid destruction of S. suis in solutions of high pH may be useful when determining the relative effectiveness of different disinfectants. Alkaline disinfectants could be more effective in destroying S. suis than neutral or acidic disinfectants. Caustic substances, although capable of destroying S. suis, would not be practical in the piggery because of the corrosion to building materials that would occur with their use.

Facklam (1980) reported that most streptococci could survive for several months on blood agar slopes maintained at 4°C, however survival in solutions at this temperature was shorter. In the present experiments, it was found that S. suis could survive in solutions for up to seven weeks at 4°C whilst when frozen at -20°C some survived for 15 weeks. These findings agree with the results described in Section B of this chapter and the findings of Clifton-Hadley and Enright (1984) who found that S. suis type 2, when mixed with faeces, could survive at 0°C for nearly 15 weeks. Schmitz and Olson (1973) found that group

E streptococci, isolated from pigs, survived for up to 165 days in sterile irradiated soils and 116 days in non-irradiated soils maintained at 4°C. These streptococci only survived for 31 days in irradiated pasture soils and four days in non-irradiated pasture soils when the soils were maintained at 37°C. The difference in survival times between irradiated and non-irradiated soils was believed to be due to competition from the normal soil microorganisms. Presumably the bacteria present in the dung and dirt of a piggery would have a similar effect. The experiments performed here showed that the addition of 5% of sterile faeces to solutions of S. suis, enhanced the survival time of these organisms. The ability of S. suis type 2 to survive in the frozen state or at the normal operating temperature of a refrigerator could pose a human health risk. This possible health risk will be discussed further in Chapter VIII.

At room temperature (17° to 24°C) S. suis was shown to survive for up to 18 days. As discussed in Section B of this chapter, the ability of S. suis to survive at this temperature may provide a means for spread of infection throughout a piggery. Clifton-Hadley and Enright (1984) reported that S. suis type 2 could survive in faeces for up to eight days at 22° to 25°C, however could not survive in dust stored at room temperature for more than 24 hours. The dust and faecal samples used in their experiments were freshly collected and would have contained other microorganisms which may have reduced the period of survival. Similarly Parker (1978) reported that human pathogenic streptococci of Lancefield's group A could survive in dust for up to several weeks. However, these group A streptococci were found to have reduced infectivity when compared with those isolated directly from a human.

Although the optimum temperature for growth and multiplication of a mesophilic bacterium is approximately 37°C (Cruickshank et al, 1973), when no nutrients were available for growth S. suis survived for only three to five days at this temperature. This may be due to the lack of nutrients for metabolism and maintenance of the normal cell function.

The inability of S. suis to grow at 45°C has been used as one of the diagnostic criteria for separating this organism from other group D streptococci (Deibel, 1977; Perch et al, 1981). In the present

experiment, no multiplication of S. suis was found at this temperature. Most strains of S. suis died within four days at 45°C. This is again probably best explained by a lack of nutrients for metabolism and the temperature inhibiting effect on essential enzyme systems of the bacteria (Lechowich, 1971).

Clifton-Hadley et al (1986a) showed that S. suis type 2 were rapidly killed at 60°C. They demonstrated that when 10^5 to 10^6 viable organisms were immersed into water at this temperature, 95% to 99.98% of these organisms were inactivated within 30 seconds. In the present experiment, all S. suis were destroyed within two minutes at 60°C with over 99.99% being destroyed in the first minute. Although the temperature of the scald tanks used for dehairing pigs in most meatworks is maintained at 60°C, the time spent in the scald tank and the subsequent rise in body temperature of the pig would not be sufficient to kill all organisms of S. suis. Although bacteria on the tonsillar surface could be destroyed, organisms deep in the crypt and tonsillar tissue survive the scalding process. However, maintaining the temperature of scald tanks at 60°C will prevent the cross contamination of carcasses with S. suis. Clifton-Hadley and Enright (1984) found that S. suis type 2 could survive for up to two hours at 50°C and up to ten minutes at 60°C. Based on these findings, they proposed that the use of hot water in the piggery had more value in diluting contaminating organisms and removing dirt from surfaces rather than killing of organisms by heat.

Cruickshank et al (1973) reported that the ability of different species of bacteria to survive when dried under natural conditions varied widely. In the present experiments, S. suis in the presence of organic matter survived for up to ten weeks when dried on microscope cover slips. Although this period of survival may be different to the survival time in the piggery, it would appear that a piggery would need to be without pigs for several months to ensure a satisfactory destruction of the S. suis present in the environment. Windsor (1977) proposed that the destocking of piggeries could be used to eradicate S. suis from a piggery. However, the difficulty in obtaining pigs free from S. suis, the cost of restocking and the long period required without pigs would make this an uneconomic, if not impossible, proposition.

Most bacteria are more tolerant to changes in osmotic pressure than are the cells of higher organisms (Cruickshank et al, 1973). All microorganisms require water for growth. The availability of water is often influenced by the solutes dissolved in the water (osmotic pressure). The water activity of a solution provides an indication of the availability of water in that solution or medium for use by the microorganisms (Lawrie, 1966; Lechowich, 1971). In the present experiment, S. suis was inactivated within one day in solutions of high salinity (10% and 20% saline solutions). However, the addition of yeast to these solutions significantly extended the period of survival to five days. These strongly saline solutions have a low water activity and hence water is not freely available for use by the bacteria. However the corrosion produced, the risk of salt toxicity to the pigs, and the impairment of bactericidal action by organic matter, would preclude the use of saline solutions as cleansing agents in the piggery.

The ability to grow in a 6.5% saline broth has been used as a test for differentiating between some group D streptococci (Stratford, 1977). In this experiment the number of S. suis type 1 in a 6.5% saline yeast solution did increase slightly before reducing within six days. This same strain of organism did not grow in a 6.5% saline broth (Chapter III). The inability to grow in 6.5% broth was described by Hommez et al (1986) as a definitive characteristic of S. suis. In a solution of 6.5% saline without yeast they survived for only two days with no increase in their number.

Streptococcus suis survived for up to 20 days in a physiological saline solution. This was the longest period of survival in the saline concentration experiments. This result was anticipated due to the similarity between the osmotic pressure of this solution and that of body fluids. At a saline concentration of 0.9%, the water activity is above 0.99, close to the optimum for most species of bacteria (Lechowich, 1971). This availability of water may account for the long period of survival in solutions with this saline concentration. Streptococcus suis survived for up to four days in distilled water and up to 12 days in distilled water with 5% yeast. Clifton-Hadley and Enright (1984) believed that the advantage of water in cleaning a piggery was in its diluting abilities, rather than any bactericidal action. The ability of S. suis to survive for up to two weeks in a

solution of distilled water and 5% organic matter supports this hypothesis.

The capacity-use disinfectant test that was used to determine the effectiveness of disinfectants, showed that two of the disinfectants tested were capable of inactivating S. suis. Although disinfectants at dilutions far lower than those recommended by the manufacturers could kill S. suis, the addition of yeast to simulate the presence of organic matter interfered with the action of two disinfectants. These disinfectants, when diluted to the manufacturers specifications, could not destroy S. suis when organic matter was present. It is interesting to note that Multikleen, which was marketed and promoted as a disinfectant, is in fact only potassium hydroxide. The bactericidal action is presumably associated with the alkaline conditions it produces. This disinfectant was recommended for use at two dilutions, 2.5% (pH 11.6) and, when organic matter is present 5% (pH 11.8). Clifton-Hadley and Enright (1984) showed that S. suis type 2 was rapidly killed (in less than one minute) by disinfectants that were routinely used by British pig farmers, even when the disinfectants were used at dilutions far less than that recommended by the manufacturers. However, all their disinfectant experiments were performed in distilled water and the effect of organic material on the disinfectant was not investigated. The presence of dust, feed and faeces in the environment of most piggeries could seriously impair the capabilities of many disinfectants. Low dilutions of liquid soap have been shown to inactivate S. suis type 2 (Anon, 1980) and Clifton-Hadley and Enright (1984) recommended that washing hands with soap and water was a satisfactory way of removing skin contamination of S. suis type 2. However, the effectiveness of this skin decontamination, would depend more on the detergent properties of soap rather than its disinfecting abilities.

In this series of experiments, yeast or faeces were added to the solutions in an attempt to simulate the presence of the organic matter that is found in all piggeries. The addition of this material increased the duration of survival of S. suis in all solutions irrespective of the pH, saline concentration or temperature of the solution. This increased survival time may be associated with the clumping of bacteria around and in the organic material. This may produce a micro-environment protecting the organisms from the

bactericidal and bacteriostatic actions of these solutions. However, it was surprising that organic matter enhanced the survival of bacteria in solutions maintained at different temperatures.

In this chapter, S. suis has been found to be susceptible to a number of insults, including high temperatures and pH, dessication, low pH and hypertonic solutions. However, if these factors were employed in a piggery, there would only be a temporary reduction in the environmental contamination with S. suis because of the continuous reinfection of the environment from the resident pigs. The risk to pigs from S. suis present in the environment is of doubtful consequence. As carriers are the main means for spread of infection between pigs, the value of taking extra specific precautions to reduce the environmental contamination with S. suis is doubtful.

CONCLUSIONS

1. Streptococcus suis survived in solutions with a range of pH's. The addition of faeces to the solutions extended this period of survival.
2. Streptococcus suis survived for up to 15 weeks when frozen in a solution of physiological saline containing yeast.
3. At a temperature of 60°C, S. suis were inactivated within two minutes.
4. Streptococcus suis were rapidly inactivated in strongly hypertonic solutions.
5. Streptococcus suis could survive for up to 20 days in solutions of physiological saline and yeast, and survived in distilled water and yeast for up to 11 days.
6. Streptococcus suis were resistant to dessication on glass cover slips, surviving for up to eight weeks. ___

7. Although disinfectants, at dilutions less than that recommended by the manufacturers, could inactivate S. suis, the presence of organic matter seriously impaired the bactericidal capabilities of the disinfectants.

8. The value of reducing environmental contamination with S. suis in the hope of decreasing rates of infection in pigs is probably minimal.

CHAPTER V

THE PREVALENCE OF STREPTOCOCCUS SUIS IN PIGS
THE RESULTS OF A CROSS-SECTIONAL SURVEY

INTRODUCTION

Both S. suis types 1 and 2 are carried within the palatine tonsils of healthy, apparently normal pigs (Williams *et al*, 1973; Clifton-Hadley and Alexander, 1980) and most isolates of these organisms have been recovered from this site. Streptococcus suis has also been isolated from other tissues of healthy pigs including the supramammary lymph nodes (Carpio, 1978), blood and joints (Clifton-Hadley and Alexander, 1981). The percentage of carriers detected by workers has varied with different herds, as well as with different groups of pigs from the same herd, as is seen in Table 2.6.

The pigs investigated in this survey were sampled only once, therefore the results recorded in this section indicate only the presence of infection at one particular time rather than the carriage of infection over a period of time. In the discussion of the results in this chapter, it is suggested that this prevalence rate is a true indication of the carrier rate.

Although infection of pigs with S. suis has been investigated by many workers, few studies have been carried out on the development of antibodies to this organism. The ELISA which offers the advantages of simplicity, speed and enables the testing of large numbers of sera at one time, was used in the present investigation to study the sero-epidemiology of infections of S. suis.

The work outlined in this chapter was undertaken to investigate:

1. The percentage of palatine tonsils infected with S. suis types 1 and 2 from pigs originating from different herds, age and sex groups.

2. The presence of S. suis in other body organs that were available for examination after pigs had been slaughtered at a meatworks.
3. The percentage of S. suis detected from live, apparently normal pigs sampled within a piggery.
4. A study of the level of antibody in a cross-section of pigs
5. Investigation of the antibody levels in feral pigs

MATERIALS AND METHODS

Abattoir Samples

Samples were collected from apparently healthy pigs slaughtered at a meatworks. The palatine tonsils, submandibular lymph nodes, female and male reproductive tracts, and samples of liver and lung were collected from pigs within 30 minutes of slaughter. The tissues were returned to the laboratory and cultured within two hours of collection. An I.F.A.T. for both S. suis types 1 and 2 was performed on the primary growth as described in Chapter III. The class (porker-16 weeks of age, baconer - 22 weeks old or chopper/back-fatter - cull sows or boars), sex and herd of origin were recorded for all pigs sampled. The herd size (number of breeding sows) was determined by either contacting the owner or by using records kept by the Pork Industry Council, Palmerston North, New Zealand.

Blood Samples

Blood samples were collected from pigs either at the meatworks or at the piggery. Piglets were bled from the cephalic vein and larger pigs sampled from either the ear vein or the anterior vena cava (Carle and Dewhirst, 1942; Hoerlein et al, 1951; Mackenzie, 1961). Blood was collected in sterile vacu-containers¹ containing 0.5 ml of 3.8% sodium citrate anticoagulant solution, or directly into plain sterile

¹ Venoject, Terumo, Tokyo, Japan

containers. One ml of blood was removed and inoculated into 20 ml of sterile Todd Hewitt Broth². At the abattoir, blood was collected during exsanguination into sterile containers with no anticoagulant and added directly to the broth within a few minutes of collection. This broth was incubated for 18 hours at 37°C. If bacterial growth was present, swabs were taken and examined by an I.F.A.T. for both S. suis types 1 and 2, as described in Chapter III.

Blood was also collected from live and slaughtered pigs for the removal of serum. The blood was collected in sterile containers and the serum removed by pipette 24 hours later. Sera was frozen and stored at -20°C. The owner, sex and class of pig (age) were recorded for all pigs bled. Frozen serum was also available from feral pigs killed in the North Island of New Zealand in the period 1982 to 1983 and collected by Dr L.M. Schollum. Information on the sex, size of pig (young or fully grown/adult) and region the pig came from was available for each of these samples.

Samples collected from Live Pigs

Nasal swabs were collected from pigs of different age groups from one herd (Herd 1 - Tables 5.1 and 5.2). In piglets less than four weeks of age, E.N.T. swabs³ were used whilst the larger Hospiswabs³ were used for older pigs. The swab was inserted one to two cm into the nasal cavity and rotated on the mucosa. Pigs less than twelve weeks of age were held in the arms of an attendant whilst older pigs were restrained with the aid of a snout rope. Vaginal, rectal and preputial swabs were also collected from the older pigs. For these samples, Hospiswabs³ were inserted two to three cm and rotated on the mucosa. Samples of expressed milk and colostrum, and swabs of the skin around the teats of lactating sows were also collected. Swabs were plated onto sheep blood agar within two hours of collection and an I.F.A.T. was performed on the bacterial growth as previously described.

² Gibco Diagnostics, Madison, Wisconsin, U.S.A.

³ Medical Wire and Equipment Co. Ltd., Corsham, Wiltshire, England

TABLE 5.1

ISOLATION RATE OF S. SUI TYPE 2 FROM THE PALATINE
TONSILS OF SLAUGHTERED PIGS

| HERD NUMBER | HERD SIZE BREEDING SOWS | NUMBER OF PIGS EXAMINED | MALE CARRIERS % | FEMALE CARRIERS % | TOTAL CARRIERS % |
|----------------|-------------------------------|-------------------------------|-----------------------|-------------------------|------------------------|
| 1 | 60 | 91 | 88 | 89 | 89 |
| 2 | 180 | 43 | 83 | 84 | 84 |
| 3 | 200 | 64 | 76 | 68 | 72 |
| 4 | 350 | 67 | 65 | 63 | 64 |
| 5 | 80 | 39 | 70 | 63 | 67 |
| 6 | 70 | 8 | 67 | 60 | 62 |
| 7 | 220 | 28 | 69 | 92 | 78 |
| 8 | 70 | 14 | 90 | 75 | 86 |
| 9 | 230 | 29 | 80 | 78 | 79 |
| 10 | 5 | 4 | 100 | 100 | 100 |
| 11 | 110 | 46 | 48 | 84 | 67 |
| 12 | 15 | 14 | 86 | 86 | 86 |
| 13 | 3500# | 9 | 50 | 100 | 67 |
| 14 | 200 | 6 | 67 | 67 | 67 |
| 15 | 400# | 14 | 86 | 86 | 86 |
| 16 | 200 | 16 | 75 | 75 | 75 |
| 17 | 80 | 9 | 75 | 40 | 56 |
| 18 | 200 | 5 | 0 | 75 | 60 |
| 19 | 30 | 10 | 63 | 100 | 70 |
| 20 | 1 | 4 | 100 | 67 | 75 |
| 21 | 0 | 2 | - | 50 | 50 |
| 22 | 1 | 3 | - | 67 | 67 |
| 23 | 200 | 5 | 100 | 75 | 80 |
| 24 | 0 | 2 | 100 | - | 100 |
| 25 | 0 | 1 | 100 | - | 100 |
| 26 | 30 | 3 | 67 | - | 67 |
| 27 | 0 | 1 | 100 | - | 100 |
| 28 | 20 | 1 | - | 100 | 100 |
| 29 | 120 | 12 | 100 | 83 | 92 |
| 30 | 1 | 4 | 50 | 100 | 75 |
| 31 | 1 | 7 | 100 | 75 | 86 |
| 32 | 0 | 2 | - | 50 | 50 |
| 33 | 0 | 1 | - | 100 | 100 |
| 34 | 0 | 1 | 0 | - | 0 |
| 35 | 0 | 2 | 0 | 0 | 0 |
| 36 | 0 | 1 | 100 | - | 100 |
| 37 | 30 | 6 | - | 50 | 50 |
| 38 | 60 | 5 | - | 60 | 60 |
| 39 | 100 | 6 | 50 | - | 50 |
| 40 | 60 | 5 | - | 80 | 80 |
| TOTAL | | 590 | 74 | 76 | 75 |

- Total number of stock

TABLE 5.2

ISOLATION RATE OF S. SUIIS TYPE 1 FROM THE PALATINE
TONSILS OF SLAUGHTERED PIGS

| HERD NUMBER | HERD SIZE BREEDING SOWS | NUMBER OF PIGS EXAMINED | MALE CARRIERS % | FEMALE CARRIERS % | TOTAL CARRIERS % |
|----------------|-------------------------------|-------------------------------|-----------------------|-------------------------|------------------------|
| 1 | 60 | 83 | 63 | 48 | 55 |
| 2 | 180 | 26 | 33 | 57 | 46 |
| 3 | 200 | 37 | 53 | 56 | 54 |
| 4 | 350 | 43 | 56 | 38 | 49 |
| 5 | 80 | 14 | 25 | 50 | 36 |
| 6 | 70 | 5 | 0 | 50 | 40 |
| 9 | 230 | 17 | 33 | 63 | 47 |
| 11 | 110 | 23 | 40 | 38 | 39 |
| 15 | 400# | 7 | 33 | 75 | 57 |
| 16 | 200 | 16 | 63 | 63 | 63 |
| 17 | 80 | 9 | 25 | 60 | 44 |
| 18 | 200 | 5 | 0 | 50 | 40 |
| 19 | 30 | 10 | 75 | 50 | 70 |
| 20 | 1 | 4 | 100 | 0 | 25 |
| 21 | 0 | 2 | - | 100 | 100 |
| 22 | 1 | 3 | - | 67 | 67 |
| 23 | 200 | 5 | 100 | 0 | 20 |
| 24 | 0 | 2 | 100 | - | 100 |
| 25 | 0 | 1 | 0 | - | 0 |
| 26 | 30 | 3 | 67 | - | 67 |
| 27 | 0 | 1 | 0 | - | 0 |
| 28 | 20 | 1 | - | 100 | 100 |
| 29 | 120 | 12 | 33 | 50 | 42 |
| 31 | 1 | 7 | 67 | 75 | 71 |
| 32 | 0 | 2 | - | 50 | 50 |
| 33 | 0 | 1 | - | 100 | 100 |
| 34 | 0 | 1 | 100 | - | 100 |
| 35 | 0 | 2 | 0 | 100 | 50 |
| 36 | 0 | 1 | 0 | - | 0 |
| 37 | 30 | 6 | - | 33 | 33 |
| 38 | 60 | 5 | - | 60 | 60 |
| 39 | 100 | 6 | 50 | - | 50 |
| 40 | 60 | 5 | - | 40 | 40 |
| TOTAL | | 365 | 51 | 50 | 51 |

- Total number of pigs

ELISA Technique

The ELISA as outlined earlier in Chapter III was used with an antigen dilution of 1/16 for both S. suis types 1 and 2, a conjugate dilution of 1/2000 and doubling serum dilutions of 1/50 to 1/400. Using these dilutions 24 sera could be tested per plate. However, on each day of testing a control sample of sow serum was also included as one of the sera to be tested. This was done to check on the precision of the test.

Determination of antibody titre

The antibody titre of each serum sample was calculated by the following procedure. Using linear regression, a straight line was calculated for each sample that followed the relationship of the log of the inverse dilution of the sample with the absorbance reading at that dilution. This line was extrapolated to intersect with an absorbance reading of 0.1. The antibody titre at this point was then calculated by taking the inverse of the anti-log of the extrapolated value. The average titre of a number of sera was determined by taking the geometric mean of these calculated titres.

RESULTS

In Tables 5.1 and 5.2 the proportion of palatine tonsils of pigs infected with S. suis types 2 and 1 respectively is recorded. Streptococcus suis type 2 was detected in 75% of 590 pigs examined, and S. suis type 1 in 51% of 365 pigs. There was no significant difference ($p > 0.6$) between the prevalence of infection for male and female pigs for either S. suis types 1 or 2. The average rates of infection were similar in all the larger herds from which many pigs were sampled. Herds with more than fifty sows had a range of infection of S. suis type 2 from 50 to 92% with a mean of 72%. With respect to S. suis type 1 these herds had a range of infection from 20 to 60% with a mean infection rate of 45.3%. However there were marked variations in detected infection rates in the smaller herds, where few pigs were examined, even though these smaller herds had a similar mean infection rate to the larger herds. Herds with less than five breeding stock had a range of infection from 0% to 100% for S. suis type 2

(mean infection rate of 71.6%) and 0% to 100% for S. suis type 1 (mean infection rate of 55.25%). Rates recorded for herds 37 to 40 from the South Island of New Zealand were similar to those reported from the North Island.

Table 5.3 records the different percentages of tonsils infected with S. suis types 1 and 2 in porkers, baconers and choppers. For both S. suis types 1 and 2 baconers had the highest rate of infection (52% for S. suis type 1 and 76% for S. suis type 2). The percentage of tonsils of porkers infected with S. suis types 1 and 2 was 49% and 68% respectively, and in choppers it was 40% and 60%. However these differences were not significant ($p > 0.2$).

Table 5.4 shows the percentage of samples, other than the palatine tonsils, from which S. suis was isolated. Streptococcus suis type 2 was detected most frequently in the submandibular lymph nodes, with 8.3% infected whilst S. suis type 1 was detected most frequently in the uterus, with 4.5% of the swabs of the primary growth showing positive fluorescence on the I.F.A.T. Streptococcus suis type 1 was detected in 4.2% of the submandibular lymph nodes and S. suis type 2 was detected in 6.4% of the uteri examined. Streptococcus suis type 2 was detected in the seminal vesicles (3.4%), vagina (2.5%), joints (5.5%) and blood (3.0%) of slaughtered pigs, however S. suis type 1 was not detected in any of these tissues. Neither S. suis types 1 nor 2 were detected in any normal lung tissue, testes, epididymides, cervixes or muscle samples tested. There was no significant difference ($p > 0.1$) between the presence of S. suis types 1 and 2 for the different organs and tissues examined.

In Table 5.5 the percentage of uteri infected with S. suis is listed for each class of pig examined. Streptococcus suis types 1 and 2 were detected more frequently in the uteri of the older choppers (cull sows) (11.1% and 11.1%), followed by the baconers (six months old) (2.9% and 5.8%). No S. suis was detected in the uteri of the younger porkers (four months old). There was no significant difference between the three groups ($p > 0.1$).

Table 5.6 records the proportion of pigs, from different age groups, with nasal swabs positive for S. suis. Streptococcus suis type 1 was not detected in any piglets younger than two days of age.

TABLE 5.3

AGE (CLASS) SPECIFIC RATES OF INFECTION WITH S. SUIS IN THE
PALATINE TONSILS OF SLAUGHTERED PIGS

| CLASS OF PIG | <u>S. SUIS</u> TYPE 1 | | <u>S. SUIS</u> TYPE 2 | |
|--------------------------|-----------------------|--------------------------------------|-----------------------|--------------------------------------|
| | NUMBER EXAMINED | NUMBER OF INFECTED TONSILS (%) | NUMBER EXAMINED | NUMBER OF INFECTED TONSILS (%) |
| Porkers | 57 | 28 (49) | 76 | 52 (68) |
| Baconers | 298 | 155 (52) | 501 | 381 (76) |
| Choppers- Backfatters | 10 | 4 (40) | 13 | 9 (69) |

TABLE 5.4

ISOLATION OF S. SUIIS FROM SAMPLES OTHER THAN THE PALATINE
TONSIL COLLECTED FROM SLAUGHTERED PIGS

| TISSUE | <u>S. SUIIS</u> TYPE 1 | | <u>S. SUIIS</u> TYPE 2 | |
|--------------------------|------------------------|--------------------------------|------------------------|--------------------------------|
| | NUMBER EXAMINED | NUMBER OF POSITIVE SAMPLES (%) | NUMBER EXAMINED | NUMBER OF POSITIVE SAMPLES (%) |
| Liver | 114 | 1 (0.9) | 114 | 3 (2.7) |
| Pneumonic Lung | 86 | 1 (1.1) | 65 | 3 (4.6) |
| Normal Lung | 24 | 0 (0.0) | 24 | 0 (0.0) |
| Submandibular Lymph Node | 24 | 1 (4.2) | 24 | 2 (8.3) |
| Testes | 32 | 0 (0.0) | 32 | 0 (0.0) |
| Epididymes | 38 | 0 (0.0) | 40 | 0 (0.0) |
| Seminal Vesicles | 27 | 0 (0.0) | 29 | 1 (3.4) |
| Uterus | 110 | 5 (4.5) | 110 | 7 (6.4) |
| Cervix | 46 | 0 (0.0) | 46 | 0 (0.0) |
| Vagina | 34 | 0 (0.0) | 40 | 1 (2.5) |
| Joints | 18 | 0 (0.0) | 18 | 1 (5.5) |
| Muscle | 22 | 0 (0.0) | 22 | 0 (0.0) |
| Blood | 99 | 0 (0.0) | 99 | 3 (3.0) |

TABLE 5.5

THE PREVALENCE OF UTERI INFECTED WITH S. SUIIS
DETECTED AT THE MEATWORKS

| CLASS OF PIG | <u>S. SUIIS</u> TYPE 1 | | <u>S. SUIIS</u> TYPE 2 | |
|--------------------------|------------------------|--------------------------------------|------------------------|--------------------------------------|
| | NUMBER EXAMINED | NUMBER OF POSITIVE SAMPLES (%) | NUMBER EXAMINED | NUMBER OF POSITIVE SAMPLES (%) |
| Porkers | 14 | 0 (0.0) | 14 | 0 (0.0) |
| Baconers | 69 | 2 (2.9) | 69 | 4 (5.8) |
| Choppers- Backfatters | 27 | 3 (11.1) | 27 | 3 (11.1) |

TABLE 5.6

THE PREVALENCE OF NASAL CHAMBERS INFECTED WITH S. SUIIS IN LIVE PIGS

| CLASS OF PIG | <u>S. SUIIS</u> TYPE 1 | | <u>S. SUIIS</u> TYPE 2 | |
|-------------------------|------------------------|--------------------------------------|------------------------|--------------------------------------|
| | NUMBER EXAMINED | NUMBER OF POSITIVE SAMPLES (%) | NUMBER EXAMINED | NUMBER OF POSITIVE SAMPLES (%) |
| 2 Days | 49 | 0 (0.0) | 49 | 1 (2.0) |
| 2-7 days | 85 | 20 (23.5) | 90 | 15 (16.7) |
| 1-4 weeks | 68 | 26 (38.2) | 70 | 20 (28.6) |
| Weaners | 69 | 40 (50.7) | 69 | 41 (59.0) |
| Porkers | 34 | 18 (52.9) | 46 | 24 (52.0) |
| Baconers | 52 | 22 (42.3) | 52 | 25 (48.0) |
| Choppers Backfatters | 45 | 22 (48.9) | 82 | 47 (57.0) |

However, 2% of piglets of this age, were infected with S. suis type 2. These piglets with positive nasal swabs for S. suis type 2, all originated from sows with positive vaginal swabs for this organism. The percentage of positive nasal swabs increased, for both S. suis types 1 and 2, until the pigs were weaned at approximately five weeks of age. After weaning, the prevalence remained relatively constant at the 50% level for both S. suis types 1 and 2.

The percentage of pigs from which S. suis was isolated from sites other than the nasal cavity (vagina, prepuce, rectum, milk/colostrum and skin around the teat) are listed in Table 5.7. Streptococcus suis was not detected in any of the rectal or preputial swabs. When the vaginas of the sows and gilts were examined, 9.4% and 11.3% were shown to have S. suis types 1 and 2 present respectively. Streptococcus suis type 1 was detected on the skin surrounding the teats of 3.2% of the lactating sows and gilts examined, and S. suis type 2 from 9.4%. No S. suis type 1 were detected in milk or colostrum samples, however 9.1% of these samples were positive for S. suis type 2.

Table 5.8 records the percentage of vaginal swabs positive for S. suis from three classes of females. All vaginal swabs from non-pregnant, unmated gilts were negative for both S. suis types 1 and 2. The highest proportion of positive swabs was found in lactating animals (15.7% for both S. suis types 1 and 2). Non-lactating, yet pregnant, sows and gilts were shown to have 9.3% and 12.4% of their vaginal swabs positive for S. suis types 1 and 2 respectively. There was a significant difference ($p < 0.05$) between the lactating stock and the unmated gilts, however there was no significant difference ($p > 0.05$) between the three groups (unmated, pregnant and lactating).

Table 5.9 records the detection of bacteraemia of S. suis in live, apparently normal pigs. Streptococcus suis type 1 was only detected in the blood of sucking piglets, with 11.1% affected. Streptococcus suis type 2 was detected in the blood of 9.7% of the suckers, 10.0% of the weaners and 5.5% of the porkers, but not from any of the baconers or breeding stock.

Figure 5.1 is a plot of the geometric means and the range of titres for S. suis types 1 and 2 for the different age groups of domestic pigs sampled. There was an increase in the mean titres as

TABLE 5.7

ISOLATION OF S. SUIS FROM SITES OTHER THAN THE NOSE IN LIVE PIGS

| SAMPLE SITE | <u>S. SUIS TYPE 1</u> | | <u>S. SUIS TYPE 2</u> | |
|----------------|-----------------------|--------------------------------|-----------------------|--------------------------------|
| | NUMBER EXAMINED | NUMBER OF POSITIVE SAMPLES (%) | NUMBER EXAMINED | NUMBER OF POSITIVE SAMPLES (%) |
| Vagina | 159 | 15 (9.4) | 159 | 18 (11.3) |
| Prepuce | 26 | 0 (0.0) | 26 | 0 (0.0) |
| Rectum | 48 | 0 (0.0) | 68 | 0 (0.0) |
| Milk/Colostrum | 22 | 0 (0.0) | 22 | 2 (9.1) |
| Teat skin* | 32 | 1 (3.1) | 32 | 3 (9.4) |

* - lactating sows

TABLE 5.8

ISOLATION OF S. SUIS FROM THE VAGINAS OF LIVE PIGS

| SAMPLE SITE | <u>S. SUIS TYPE 1</u> | | <u>S. SUIS TYPE 2</u> | |
|---------------------------------------|-----------------------|--------------------------------|-----------------------|--------------------------------|
| | NUMBER EXAMINED | NUMBER OF POSITIVE SAMPLES (%) | NUMBER EXAMINED | NUMBER OF POSITIVE SAMPLES (%) |
| Non-lactating Pregnant Sows and Gilts | 97 | 9 (9.3) | 97 | 12 (12.4) |
| Non-pregnant Lactating Sows | 38 | 6 (15.7) | 38 | 6 (15.8) |
| Non-pregnant Gilts | 24 | 0 (0.0) | 24 | 0 (0.0) |

TABLE 5.9

PREVALENCE OF BACTERAEMIA DUE TO S. SUIIS IN LIVE PIGS

| CLASS OF PIG | <u>S. SUIIS</u> TYPE 1 | | <u>S. SUIIS</u> TYPE 2 | |
|----------------------|------------------------|-----------------------------------|------------------------|-----------------------------------|
| | NUMBER TESTED | NUMBER WITH BACTERAEMIA (%) | NUMBER TESTED | NUMBER WITH BACTERAEMIA (%) |
| Suckers 0-4 weeks | 54 | 6 (11.1) | 72 | 7 (9.7) |
| Weaners 5-8 weeks | 30 | 0 (0.0) | 30 | 3 (10.0) |
| Porkers | 14 | 0 (0.0) | 18 | 1 (5.5) |
| Baconers | 12 | 0 (0.0) | 13 | 0 (0.0) |
| Breeding Stock | 10 | 0 (0.0) | 10 | 0 (0.0) |

FIGURE 5.1

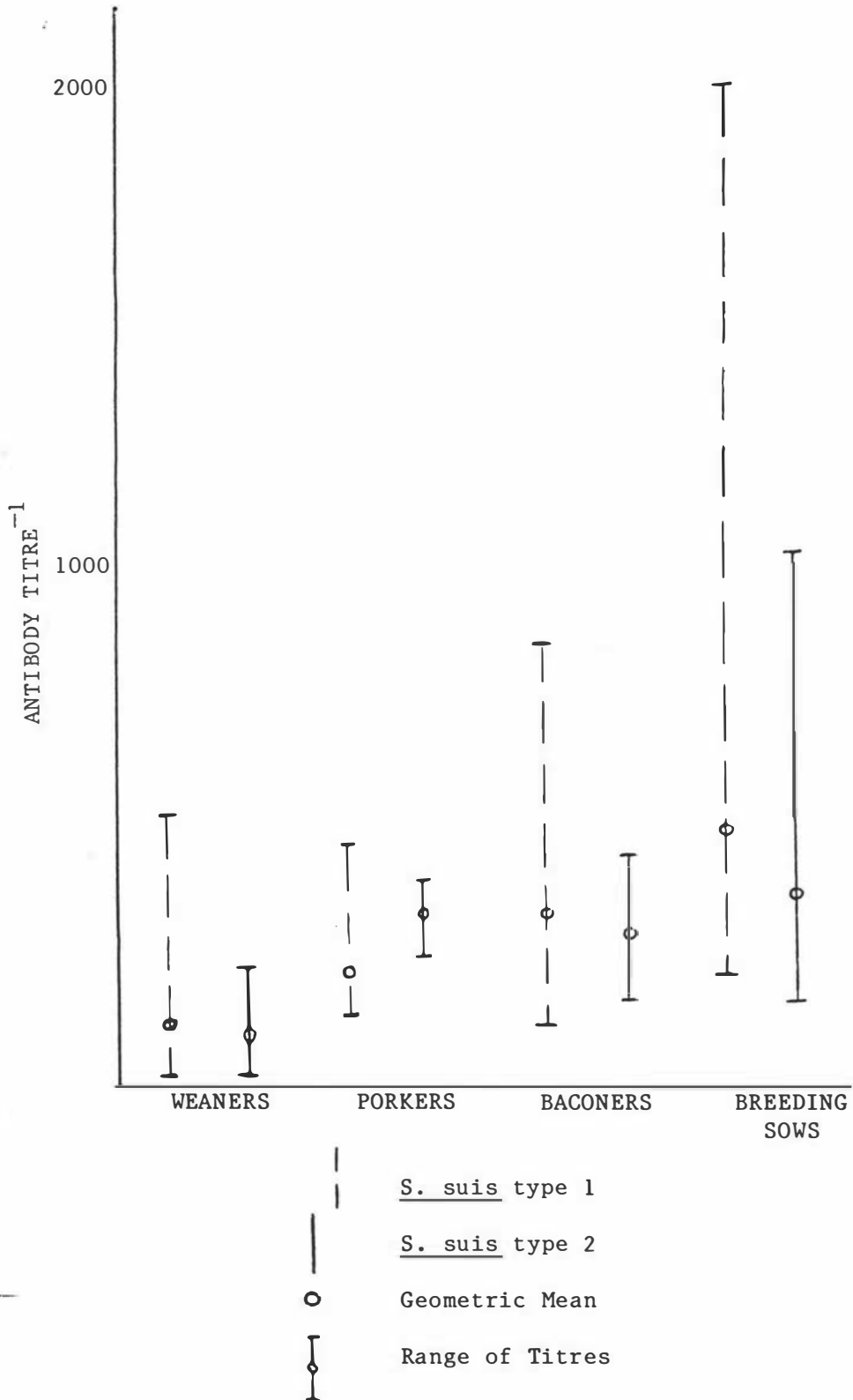
RANGE OF TITRES TO S. SUIIS TYPES 1 AND 2 IN PIGS

pigs got older. In the same group of pigs, there was a greater range for titres to S. suis type 1 than for titres to S. suis type 2. There was no significant difference in the geometric mean titres for pigs of similar age groups originating from different herds ($p > 0.5$ for S. suis type 1 and $p > 0.1$ for S. suis type 2). There was also no significant difference in the titres for pigs of different sexes ($p > 0.5$) for both S. suis types 1 and 2.

Table 5.10 shows the reciprocal of the geometric mean and range of titres for S. suis in both sexes of feral pigs of two different age groups. There was no significant difference between the titres for males and females for S. suis types 1 or 2 ($p > 0.2$). There was also no significant difference between the age and titre for S. suis type 1 ($p > 0.3$) and for S. suis type 2 ($p > 0.9$); although with S. suis type 1 there appeared to be an apparent increase in the titres with age. However, there was a significant difference ($p < 0.001$) between titres to S. suis types 1 and S. suis type 2 in both age groups.

DISCUSSION

In this survey each pig was sampled only once, therefore the results recorded here describe the percentage of pigs infected with S. suis at one particular time and provides data on point prevalence (MacMahon and Pugh, 1970; Blackmore and Harris, 1987). Because of the long duration of infection (Clifton-Hadley and Alexander, 1984) and the results of work described later, it can be assumed that the pigs detected as infected with S. suis were indeed carriers of this organism. Carriers have been defined as apparently unaffected animals that are infected for a period of time and are also capable of transmitting the infection (Schwabe et al, 1977). In a series of cross-sectional surveys, an animal could be falsely described as a carrier if reinfection, rather than long term carriage of the organism occurred. Such circumstances can occur when there is a sufficiently high population density to allow cycles of reinfection or when there is a continuous supply of susceptible animals. In the latter circumstance, the infection could be maintained within the population without long term carriage by individuals, such as occurs with Leptospira interrogans serovar ballum in Rattus norvegicus (Hathaway

TABLE 5.10

GEOMETRIC MEAN TITRES TO S. SUIS IN FERAL PIGS

| AGE GROUP | <u>S. SUIS</u> TYPE 1 | | <u>S. SUIS</u> TYPE 2 | |
|-----------|---|---|---|---|
| | RECIPROCAL OF TITRES IN MALES (range) | RECIPROCAL OF TITRES IN FEMALES (range) | RECIPROCAL OF TITRES IN MALES (range) | RECIPROCAL OF TITRES IN FEMALES (range) |
| YOUNG | 90 (11-281) | 68 (22-225) | 557 (126-1600) | 409 (134-1000) |
| ADULT | 141 (27-420) | 125 (32-401) | 492 (172-1200) | 418 (276-633) |

and Blackmore, 1981). Reinfections could also occur from the environment, or from other animal species which are the true maintenance hosts. However, in the case of S. suis pigs would appear to be true carriers of this organism. This is because of the known long duration of infection, the lack of any other obvious maintenance hosts, and the finding in the present investigation that the only pig kept on one farm was infected with both S. suis types 1 and 2. As pigs infected with S. suis type 2 can subsequently develop clinical disease (Clifton-Hadley and Alexander, 1981), a more precise definition of the carrier status of pigs is that of latent carriers. Schwabe et al (1977) classified a latent carrier as an animal with an inapparent infection that was subsequently capable of developing signs of disease probably associated with an altered host response. This was supported by Clausen (1980) who believed that infection with S. suis alone, would not produce disease. He considered that for disease to occur, secondary unknown factors must also be present. A carrier of S. suis could be defined as a pig with an infection of S. suis which is normally inapparent but is of sufficient duration to allow cross infection to a susceptible maintenance population. Thus, like any other long term carrier of an infectious agent, the duration of infection with S. suis is sufficient to allow spread between generations.

Streptococcus suis types 1 and 2 were detected in 51% and 75% respectively of the tonsils collected from slaughtered pigs. There were only minor differences between the infection rates for male and female pigs. This similarity in the sex specific infection rates was to be expected because of the similar handling both sexes receive within a modern piggery. The percentage of infected palatine tonsils for each of the three classes of pigs slaughtered (porkers, baconers and choppers) were also similar. Again these age specific rates were expected to be comparable because of the rapid spread of infection between pigs at an early age, and the long duration of infection (Clifton-Hadley and Alexander, 1984; Clifton-Hadley et al, 1984b).

Clifton-Hadley et al (1984a) reported that in 12 herds the percentage of tonsillar carriers of S. suis type 2 varied from 20% to 90%. In batches of pigs from the same piggery the rate varied from 0% to 100%. In this investigation of 40 herds, the proportion of tonsils infected with S. suis type 2 also varied from 0% to 100%. However this

marked variation appeared not to be associated with differences between piggeries, but rather with the number of pigs sampled from each piggery. The range in prevalence for 14 herds, with more than 10 pigs tested, was 64% to 92%. In herds where no infected pigs were detected only one or two animals were sampled. Similarly for S. suis type 1 (Table 5.2), the infection rate varied from 0% to 100% for the 33 herds tested. This variation was reduced to 36% to 70% when only the 10 herds were considered from which more than 10 pigs were sampled. Herds which had either no animals detected as infected with S. suis types 1 or all animals recorded as infected, also had only one or two pigs sampled. These findings differ significantly from those of Clifton-Hadley et al (1984a), who demonstrated a marked variation in the proportion of detectable carriers (0% to 100%) even when sampling batches of ten animals from the same herd. This difference in results may be associated with the use of a test of lower sensitivity by Clifton-Hadley et al (1984a) as discussed earlier in Chapter III. Based on the assumption that there is a 100% prevalence of infection with S. suis, the I.F.A.T. is 75% sensitive for the detection of S. suis type 2 and 51% for the detection of S. suis type 1 (Table 5.1 and 5.2). Therefore if only one pig was sampled from a herd there is a 25% chance of recording a false negative result for S. suis type 2 and a 49% chance of a false negative result with S. suis type 1. Similarly if two pigs are sampled the probability of detecting two negative samples is 6.25% for S. suis type 2 and 24% for S. suis type 1. These chances for detecting false negative results are certainly within the realm of biological probability. The variation in the recorded infection rate for different herds appears to stem from differences in the number of pigs sampled rather than intrinsic differences in the carrier status of the herd. Small herds of pigs are also likely to be infected because of the dispersed nature of S. suis throughout the pig herds of New Zealand and the rapid spread and long duration of the infection. In this investigation, pigs originating from some of the largest producers of breeding stock in New Zealand were tested and found to be infected. The presence of infection in these herds may provide simple and rapid dispersion of S. suis to most pig herds in New Zealand. Arends et al (1984) detected more carriers of S. suis type 2 when the palatine tonsils were sampled several times. This was because of the small numbers of S. suis present in some palatine tonsils. In retrospect, in the present study, if the tonsils collected from pigs originating from small herds had been incised and sampled in

more than one plane, it is highly probable that S. suis would have been demonstrated in all the New Zealand pig herds tested.

Streptococcus suis type 1 was detected in fewer tonsils than S. suis type 2. This could theoretically be associated with a diagnostic test of lower sensitivity (75% compared with 51%), fewer organisms present within the tonsil or an actual lower prevalence of pigs infected with S. suis type 1. However, as sampling of the tonsil in multiple planes increased the detection of S. suis type 1 as well as type 2 (Chapter III), it would appear that 100% of slaughtered pigs are infected with both S. suis types 1 and 2, although there are fewer numbers of S. suis type 1 than S. suis type 2 present in the tonsil.

Streptococcus suis types 1 and 2 were detected in 4.2% and 8.3% respectively of the submandibular lymph nodes examined. This is in agreement with the findings of Williams et al (1973) who also isolated S. suis type 1 from this lymph node. However, these results are contrary to the findings of Clifton-Hadley and Alexander (1980) who were unable to isolate S. suis type 2 from these lymph nodes. As the efferent lymphatic vessels from the tonsil drain to this lymph node (Saar and Getty, 1964; Williams and Rowland, 1972), it would be expected that infection of the palatine tonsil may occasionally lead to infection of the submandibular lymph node.

Both S. suis types 1 and 2 were detected in areas of lung with enzootic pneumonia, however neither could be found in normal lung tissue. These findings agree with the results of North American workers who frequently isolated S. suis type 2 from pneumonic lesions (Koehne et al, 1979; Sanford and Tilker, 1982). The failure to detect S. suis in apparently normal lung tissue may have been associated with the low number of samples collected, few organisms present in the tissue, an actual absence of S. suis in healthy lung or conversely an apparent ability of S. suis to survive only in damaged lung tissue. Sanford and Tilker (1982) proposed that when S. suis type 2 was isolated in mixed cultures from pneumonic lungs, the bacterium was a secondary invader after Mycoplasma hyopneumoniae had caused the initial damage. As S. suis type 2 was detected in the blood from 3% of normal, apparently healthy pigs slaughtered, it would be anticipated that S. suis type 2 may occasionally be detected in normal lung tissue due to the presence of blood in this tissue.

The detection of S. suis type 2 in the blood of apparently healthy pigs at the time of slaughter, has important public health implications. As most cases of disease in humans have originated from meat-workers following injuries (Zanen and Engel, 1975; Joynson, 1980), these bacteraemic pigs are a potential health risk. However, the risk would appear to be small as the number of reported cases of infection in humans with S. suis type 2 is less than 100 (Robertson, 1986). As 3% of pigs were bacteraemic, other factors as well as contact with organisms are involved in the development of disease of humans.

Clifton-Hadley et al (1986b) could not isolate S. suis type 2 from the muscle of infected pigs and similarly in the present investigation S. suis was not detected in this tissue. However if S. suis type 2 can be detected in the blood, some organisms must be present in all tissues including muscle, although presumably the number of organisms per unit weight of muscle was below the threshold of detection. As S. suis type 2 can survive in tissue that is either frozen or maintained at 4°C (Chapter IV; Clifton-Hadley et al, 1986b) it is possible that some cuts of retail pork could contain this organism. The public health implications of this will be discussed further in Chapter VIII.

Streptococcus suis types 1 and 2 were detected in the liver of 0.9% and 2.7% respectively of apparently normal healthy pigs. The presence of these organisms in the liver does not mean that an infectious process is occurring as the organisms may have originated from residual blood present in this tissue. However, only one of the pigs with a bacteraemia had a concurrent positive liver sample. If there are only a small number of S. suis present in the blood and consequently in other tissues, the probability of detecting organisms on an I.F.A.T. from the bacterial growth of swabs is low. Therefore the sensitivity of the test is also low as discussed earlier. This may account for the detection of positive liver samples from pigs with negative blood samples and could mean the percentage of healthy yet bacteraemic pigs slaughtered at the meatworks may be even higher than the 3% recorded here. The finding of positive liver samples with concurrent negative muscle samples could be explained by the greater blood content of liver post mortem compared with muscle post mortem (Warriss and Leach, 1978).

Streptococcus suis types 1 and 2 were found in 4.5% and 6.4% respectively of the female reproductive tracts examined. These findings may indicate either venereal transmission of S. suis or a haematogenous spread of infection to the female reproductive tract. The discovery of S. suis in apparently normal female reproductive tracts is interesting in light of the belief that the organism can be associated with vaginitis, abortions, still births and endometritis as reported by Jones (1976a), Swann and Kjar (1980) and Yurukov and Ganovski (1981). As S. suis can be isolated from healthy reproductive tracts, it is possible that they can also be isolated from "diseased" tracts. Therefore, although S. suis can be isolated and is associated with a reproductive disorder, it cannot be inferred that S. suis caused the condition. Streptococcus suis was not detected in any of the male reproductive tracts examined, other than one isolate of S. suis type 2 from a seminal vesicle. These results could indicate that although sexual transmission may be possible, long term infection of the male reproductive tract appears unlikely.

A pure growth of S. suis type 2 was detected from one arthritic joint condemned by meat inspectors at the meatworks. Turner (1978, 1982) and Turner *et al* (1980) also isolated streptococci from joints of pigs condemned for arthritis in South African meatworks. As well as causing losses from sudden deaths, it would appear that S. suis can also reduce the financial return to the pig farmer by increasing the percentage of partially condemned carcasses. However as no "normal" joints were cultured, it cannot be inferred that S. suis was the aetiological agent of the arthritis. The organism could have been an opportunistic secondary invader after initial damage or could have been present as a result of a concurrent bacteraemia.

Streptococcus suis types 1 and 2 were also detected in the blood of live pigs sampled at the piggery. Streptococcus suis type 1 could only be demonstrated in the blood of 11.1% of suckers. As S. suis type 1 can produce a vegetative valvular endocarditis (Pedersen *et al*, 1984), it is possible that organisms are shed intermittently from such lesions in a way similar to that demonstrated by Pedersen *et al* (1981) with group R/S streptococci. Streptococcus suis type 2 was found most commonly in the blood of weaned pigs (10%) which corresponds with the age group reported to have the highest level of clinical disease and

within which the spread of infection is most rapid (Clifton-Hadley and Alexander, 1981). The detection of S. suis type 2 in the blood of apparently normal pigs agrees with the findings of Clifton-Hadley and Alexander (1981) and Pedersen et al (1981). These workers found that some artificially induced bacteraemic pigs showed no obvious clinical signs. In the present study, S. suis was not detected in the blood of any of the older pigs (baconers or choppers). This may be due to the small number of pigs tested (22), a test of low sensitivity or a true absence of organisms in the blood of these pigs. As S. suis was detected in the blood of similar aged pigs at slaughter, it would appear that if more pigs of this age group had been examined, bacteraemias may have been detected.

Streptococcus suis types 1 and 2 were not detected in any of the uteri collected from porkers slaughtered at the meatworks. However S. suis types 1 and 2 were detected in 2.9% and 5.8% respectively of the uteri of baconers and both organisms were present in 11.1% of the uteri of choppers. Although these differences were not significant ($p > 0.1$) there does appear to be a trend indicating an increasing presence of S. suis in the uterus with age. This apparent increase in prevalence with age may be associated with greater exposure to the organism. The uteri could have been infected via the haematogenous route or from an ascending infection. If the duration of infection in the uterus is assumed to be infinite (restricted only by the life of the pig) and there is a constant annual incidence rate; for each year of life the prevalence of disease in a cohort should increase by that annual incidence rate. Therefore there should be a direct correlation between age and the detection of uteri infected with S. suis. Similarly, there appears to be an increase in the percentage of positive vaginal swabs with age in live healthy pigs tested in the piggery. Streptococcus suis was not detected in the vaginal swabs of the non-pregnant gilts. However, 9.3% and 12.4% of the non-lactating yet pregnant sows and gilts, and 15.7% and 15.8% of the non-pregnant lactating sows had vaginal swabs positive for S. suis types 1 and 2 respectively. Clausen (1980), Clifton-Hadley and Alexander (1980) and Rickert et al (1982) could not isolate S. suis type 2 from the vaginas of sows using their traditional microbiological techniques. This is in contrast to these results where, on average, 11.3% of vaginas were found to be infected. In the present investigation, no S. suis could be detected in the prepuce of boars which was in agreement with the

findings of the previous workers. However, Clifton-Hadley (1985) reported isolation of S. suis type 2 from the prepuce of a clinically healthy 15 week old boar. The detection of S. suis in the female reproductive tract and not in the male reproductive tract, may indicate a predilection site for the female tract similar to that of the palatine tonsil. If venereal transmission of S. suis does occur, the boar probably acts purely as a passive mechanical method of spread rather than an active source of infection. However, Carol-Dumitriu et al (1981b) isolated streptococci from 31 of 75 semen samples examined, but the specific identity of the streptococci was not reported. In Chapter VII experiments are described that investigate the possibility of sexual transmission of S. suis.

Streptococcus suis was not detected in any of the rectal swabs examined. This would indicate that S. suis is probably not part of the normal gastrointestinal flora, unlike other group D streptococci such as S. faecalis and S. faecium which are readily detected in the faeces of healthy pigs (Smith and Jones, 1963; Deibel, 1977).

Both S. suis types 1 and 2 were isolated from swabs taken from the skin surrounding the teats of lactating sows. These organisms may have originated from the environment, have been natural commensals on the skin, have come from the milk or colostrum, or most likely have been passively transferred from the infected oral cavities of sucking piglets. The presence of infection with S. suis in pigs older than two days (Table 5.6), and the frequent sucking by piglets, at least once an hour (Jeppesen, 1984), would tend to support the hypothesis of a passive spread of S. suis to the skin around the teat. The failure to detect S. suis from the skin around the teat of non-lactating sows mitigates against the possibility of infection originating from environmental sources or that S. suis is part of the normal bacterial flora of the skin. As S. suis type 2 was detected in the milk or colostrum of some pigs, it is therefore possible that organisms on the skin around the teat might have originated from the milk. Conversely, the organisms that were present in the milk may well have originated from an ascending infection up the teat canal from organisms carried by the piglets. Sala et al (1985) isolated S. suis type 2 from the milk of sows with the mastitis-metritis-agalactia syndrome. They believed S. suis type 2 played an important role in the development of this syndrome and the subsequent development of meningitis in piglets.

However the detection of S. suis in the milk or colostrum of apparently normal sows would question the validity of their hypothesis.

Streptococcus suis type 1 was not detected in nasal swabs of piglets younger than two days of age, however 2% were infected with S. suis type 2. After this age there was a rapid spread of infection, so that by weaning (35 days) over 50% of swabs of the nasal cavities were positive for both S. suis types 1 and 2. These findings support those of Clifton-Hadley et al (1984b) who showed that the palatine tonsils of non-infected pigs could become infected within five days, when the pigs were housed with carrier pigs. However, Clifton-Hadley et al (1984a) could not detect S. suis type 2 in piglets younger than three weeks, even when some of these piglets originated from infected sows. This failure to detect S. suis type 2 again may be explained by the low sensitivity of the test or it may be due to a different pattern of infection with S. suis type 2 in pigs in Britain compared with New Zealand. Once pigs were weaned (approximately five weeks of age), the percentage of infected animals remained relatively constant for both S. suis types 1 and 2. Pigs which were not detected as being infected with S. suis could, however, still have had infected palatine tonsils. The failure to detect infection was probably due to the use of a test of lower sensitivity (testing palatine tonsils for infection is more sensitive than nasal swabbing - Chapter III).

All piglets younger than two days old which were infected with S. suis type 2, originated from sows with vaginal infections of S. suis type 2. Infection may have occurred in utero, have been acquired by mechanical contamination during passage through the vagina or from post-natal infection either from the vagina or oro-nasal pharynx of the sow. As lactating sows also have the highest rate of vaginal infection, there is a strong possibility that infection occurs during or soon after the birth process. The spread of infection in litters from vaginal carriers and non-carriers is investigated further in Chapter VI.

Clifton-Hadley and Alexander (1981) and Clifton-Hadley et al (1984b) demonstrated that S. suis type 2 could persist in the tonsils of healthy carrier pigs which had circulating antibodies detectable by the bactericidal or ELISA tests. In the present work it is evident

that antibodies to S. suis are not protective. Clifton-Hadley et al (1984b) found there was no apparent correlation between the ELISA titre and the ability to detect S. suis type 2 in nasal or tonsillar swabs. In the present study, the only apparent correlation between infection and titre was an increasing titre with age.

In a cross-sectional survey of sera collected from domesticated pigs, titres to both S. suis types 1 and 2 were the highest in the older breeding stock. This increase in titres with age, could be associated with the longer period of exposure to these organisms. The frequent contact of sows with their piglets may also allow further colonization of the nasal mucosa and the subsequent stimulation of antibody production. Due to the high density of pigs in most intensive piggeries, pigs have ample opportunity to have contact with numerous other pigs, some of which would be expected to be actively shedding S. suis.

The only difference between titres for domesticated and feral pigs was with S. suis type 1. Titres in domesticated pigs were significantly higher ($p < 0.001$) than those for feral pigs. This may indicate differences in the pattern of infection for S. suis type 1 for these two types of pigs. There was no significant difference between the titres of S. suis types 1 and 2 from domesticated pigs of the same class ($p > 0.05$) and also for titres to S. suis type 2 between feral and domesticated pigs ($p > 0.2$). This may indicate that the pattern of infection with S. suis type 2 is similar in both domesticated and feral pigs. The differences in titres for S. suis type 1 could be explained if the assumption that S. suis type 1 is carried for life is incorrect. If a series of reinfections occur, the prevalence of infection to S. suis type 1 and hence the titre to this organism would be dependent on the population density as occurs in relation to infection with Leptospira interrogans serovar ballum in Rattus norvegicus (Hathaway and Blackmore, 1982). The high population density of domesticated pigs would allow the spread of S. suis type 1 from infected to non-infected pigs. This would be a dynamic system with reinfections occurring, and would therefore explain the persistence of high titres in domesticated pigs as was found in the present investigation. With the smaller population density of feral pigs, there would be less chance of reinfections occurring, therefore a lower prevalence of infection, and consequently a lower geometric

mean titre compared with domesticated pigs. Similarly smaller herds of domesticated pigs may also be expected to have lower mean geometric titres to S. suis type 1 than larger herds.

Titres to both S. suis types 1 and 2 were similar in pigs of different sexes, and pigs from different herds. These findings are to be anticipated because of the comparable management practices of most intensive piggeries, the similar methods of handling both sexes of pigs, and the similar prevalence rates in different piggeries. Titres to S. suis were also comparable in feral pigs of either sex.

CONCLUSIONS

1. Although 100% of pigs are assumed to be infected with S. suis, S. suis type 1 was detected in 51% and S. suis type 2 in 75% of palatine tonsils collected at the meatworks. These lower prevalence rates are associated with the sensitivity of the I.F.A.T.
2. Variation in the recorded prevalence of infection with S. suis in pigs from different herds was thought to be due to differences in sample sizes rather than true differences in prevalence between herds.
3. The prevalence of infection with S. suis was similar in pigs of different sex and age. This is probably a reflection of the similar handling of pigs in intensive herds.
4. As S. suis can be detected in the blood of 3% of apparently normal pigs slaughtered at a meatworks, S. suis is likely to be present in all body tissues during that bacteraemic phase.
5. The failure to detect S. suis in tissues of bacteraemic pigs is associated with the low numbers of bacteria present.
6. The presence of S. suis type 2 in edible tissue could pose a public health risk.
7. Some piglets from sows carrying S. suis type 2 in their vaginas became infected earlier than piglets from non-vaginal carriers and were probably infected at the time of birth.

8. Venereal transmission of S. suis does not appear to be an important method of spread of infection.

9. The proportion of uteri and vaginas infected with S. suis increased with the age of the pigs. These organs may be another site of carriage of infection similar to the palatine tonsil.

10. As the pattern of titres to S. suis types 1 and 2 are similar in domesticated pigs, the pattern of infection and development of immunity would appear to be similar in these pigs for both S. suis types 1 and 2.

11. As titres to S. suis type 1 were low and the range of titres large in feral pigs, there appears to be a difference between the pattern of infection by S. suis type 1 compared with S. suis type 2 in feral pigs.

12. The differences in titres of antibody to S. suis types 1 and 2 could be explained by the hypothesis that infection by S. suis type 2 was of a permanent nature, while that of S. suis type 1 was dependent on a series of reinfections.

CHAPTER VI

A LONGITUDINAL SURVEY OF INFECTION WITH STREPTOCOCCUS SUIS

INTRODUCTION

Although many workers have performed cross-sectional studies on the infection of pigs with S. suis, there have been few investigations studying the infection in individual pigs over a period of time. The present investigation was designed to study the level of antibodies to S. suis in a litter of pigs from birth to slaughter, and to follow the natural development of infection in five litters of pigs. The aim was to determine the age at which infection first occurred in piglets, to follow the spread of infection throughout the litters and to correlate this spread with the development of an immune response.

MATERIALS AND METHODS

Sows

Four sows and one gilt, from Herd 1 (Chapter V) were selected on the basis that all would farrow within a three day period. All sows were transferred to the farrowing house five days prior to their expected farrowing date. Three sows and the gilt were placed in one farrowing room whilst the remaining sow was placed in another room with three other sows which had already farrowed. All farrowing pens had previously been hosed out and disinfected with an alkaline disinfectant¹. Vaginal and nasal swabs had been collected from the four sows during a six month period prior to this farrowing. Further nasal and vaginal swabs were collected from all five breeding pigs in the four week period after farrowing. The farrowing date, litter size and the number of previous litters were recorded for each breeding animal.

¹ Multikleen, KW Products Ltd., Auckland New Zealand

Piglets

Each piglet was identified by a consecutively numbered ear tag, with each litter having a different coloured tag. Nasal swabs were collected from each piglet within 24 hours of birth and thereafter twice weekly for the first eight weeks of life. E.N.T. swabs² were used for sampling piglets younger than four weeks of age and the larger Hospiswabs² were used for older pigs. Swabs were inserted approximately one cm into the nasal chamber and rotated on the mucosa. The swab was returned to the laboratory within one hour of collection and plated onto sheep blood agar. An I.F.A.T. for both S. suis types 1 and 2 was performed on a smear of the growth as described in Chapter III.

When piglets were two days old they were injected with an iron/vitamin B12 preparation³, their tails were docked and incisor teeth clipped. The pigs under study were handled in a similar manner to other pigs in the herd except for the extra handling required for taking samples.

When the piglets were 26 days old, 21 piglets were taken without any form of selection from a cross-section of all five litters. These piglets were weaned into individual cages and housed in a building over two km from the piggery. These cages had been empty for the preceding two months and had previously housed sheep. Pigs were last kept in the pens approximately six months prior to the introduction of these pigs. At the time the 21 pigs were weaned, the gilt and one sow were returned to the dry sow accommodation. The unweaned piglets from these two animals were cross-fostered onto the three remaining sows.

At the age of five weeks, six of the segregated weaned pigs and four unweaned piglets were euthanased with an intravenous injection of sodium pentobarbitone⁴ and were autopsied. Swabs were collected from the nasal cavities, heart blood and meninges, and samples of tissue

² E.N.T. Swabs, Medical Wire and Equipment Ltd.,
Corsham, Wiltshire, England

³ Rubrafer Improved, E.R.Squibb and Sons (NZ) Ltd,
Auckland, N.Z.

⁴ Pentobarb 300, South Island Chemicals Ltd.,
Christchurch, N.Z.

from the brain, liver, kidney, tonsil and female reproductive tract were collected. In the laboratory swabs were taken aseptically from these tissues. All swabs were plated onto sheep blood agar and an I.F.A.T. for both S. suis types 1 and 2 performed on any growth present.

The rest of the sucking piglets were weaned at five and a half weeks of age and transferred into the normal weaning house of the piggery. After three weeks in isolation, the early weaned pigs were also transferred to the same weaning room and divided into two groups. When the pigs were eight weeks old they were all transferred into the growing shed and housed in two pens, with pigs of similar size being housed together. Figure 6.1 summarizes the movement and handling of pigs in the litters under investigation.

When possible, any pig that died was collected and an autopsy performed. Samples from these dead pigs were collected and handled as above.

Environmental Isolation of S. suis

Swabs were collected from the feed, water, floors, feed troughs and dust from all accommodation areas. In the farrowing shed, feed troughs were of steel construction and incorporated a nipple drinker. They were made from concrete in the grower and fattening pens and were plastic in the isolation pens.

Serological test (ELISA)

Blood was collected from piglets of the five litters by anterior vena cava puncture using the method of Mackenzie (1961). It was collected at weekly intervals for the first six weeks of the pigs' lives. Another litter of nine pigs from this herd was also routinely bled to obtain further information on serological responses to S. suis. These pigs were bled initially at weekly and then two-weekly intervals until the pigs were slaughtered at 22 weeks of age. Blood was collected from the anterior vena cava, cephalic vein, ear veins, or from the ventral coccygeal vessels. After collection all samples

FIGURE 6.1

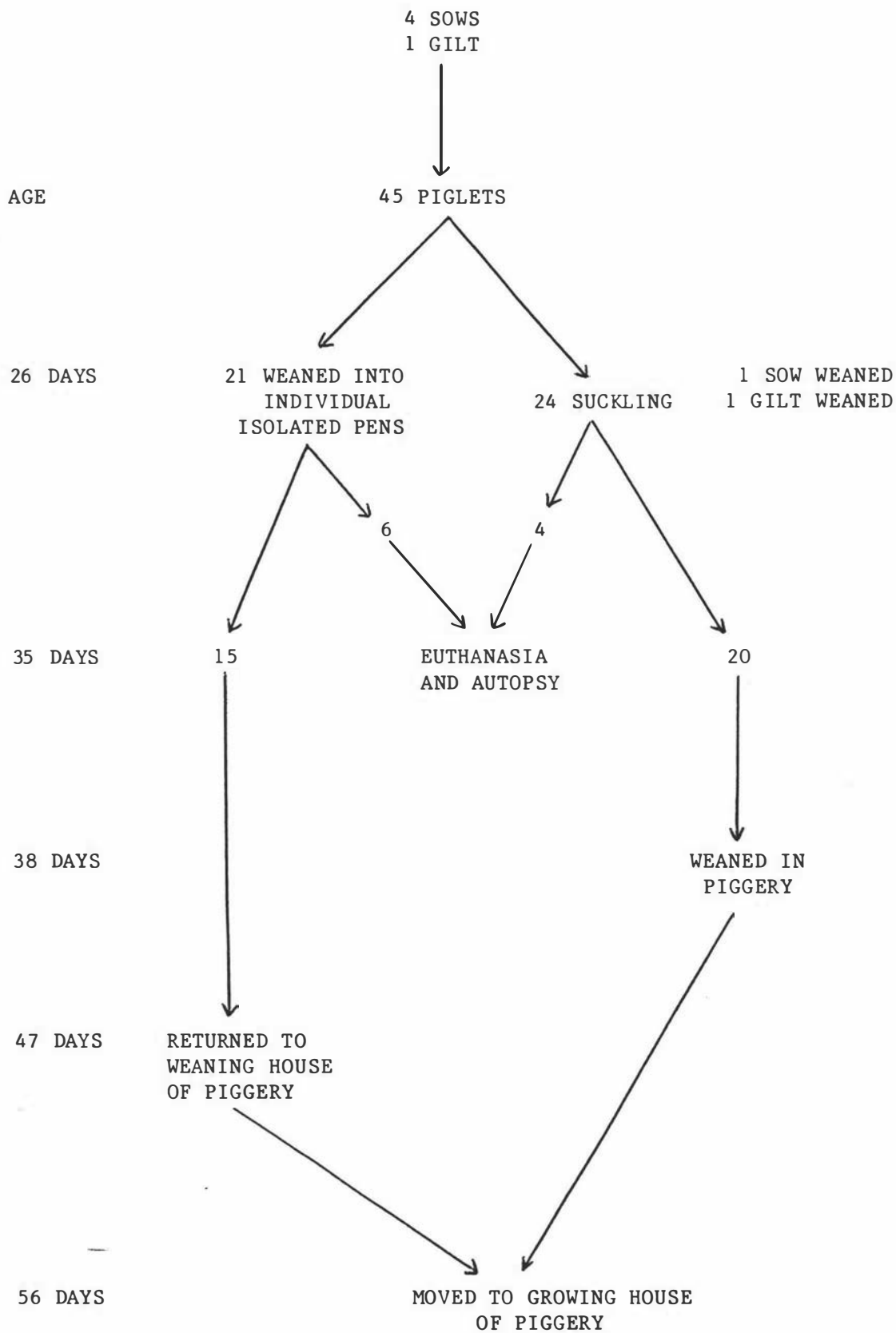
HANDLING OF PIGS IN LITTERS UNDER STUDY

were maintained at room temperature and the serum removed by pipette 24 hours later. An ELISA for detecting antibodies to S. suis types 1 and 2 was performed and titres were calculated by the methods described in Chapters III and V.

RESULTS

In Table 6.1 the reproductive history and the detection of S. suis from nasal and vaginal swabs is listed for the sows and the gilt in the six month period prior to the birth of the five litters under investigation. Both before and after farrowing positive nasal swabs, for S. suis types 1 and 2, were detected from all sows. In the week prior to farrowing, none of the sows were found to have vaginal swabs positive for S. suis. However S. suis type 2 had earlier been detected in vaginal swabs from sow A. After farrowing, vaginal swabs from sow A were found to contain S. suis type 1 and vaginal swabs from both sows A and C contained S. suis type 2 (Tables 6.2 and 6.3).

None of the one-day old piglets were infected with S. suis type 1. However by the age of four days, S. suis type 1 was detected in the nasal swabs of some piglets from four litters. At least one piglet from each litter was infected with S. suis type 1 by the age of seven days. In Figure 6.2 the prevalence of nasal infections with S. suis type 1 is compared with the age of the piglets. By the time piglets were 25 days old, 95% had recorded at least one positive nasal swab for S. suis type 1 and all were positive by the age of 38 days.

Three of the nine piglets from sow C were infected with S. suis type 2 when the piglets were only one day old. Streptococcus suis type 2 had been detected in vaginal swabs collected after farrowing from this sow. No other piglets were infected at this time, however by the age of three days, some piglets from all litters had positive nasal swabs. In Figure 6.3 the percentage of pigs infected with S. suis type 2 is plotted against their age. By the time piglets were 14 days old, 95% had recorded at least one positive nasal swab for S. suis type 2 and all were positive by the age of 26 days.

TABLE 6.1

THE REPRODUCTIVE HISTORY AND DETECTION OF S. SUIIS IN SOWS
USED IN THE COHORT STUDY

| SOW IDENTIFICATION | PARITY | NUMBER OF PIGLETS BORN IN COHORT | S. SUIIS NASAL (%) | TYPE 1# VAGINAL (%) | S. SUIIS NASAL (%) | TYPE 2# VAGINAL (%) |
|-----------------------|--------|--|--------------------------|---------------------------|--------------------------|---------------------------|
| A | 2 | 11* | 4/12 (33.3) | 0/12 (0.0) | 6/12 (50.0) | 4/12 (33.3) |
| B | 7 | 11 | 2/12 (16.7) | 0/12 (0.0) | 8/12 (66.7) | 0/12 (0.0) |
| C | 3 | 9 | 4/12 (33.3) | 0/12 (0.0) | 6/12 (50.0) | 0/12 (0.0) |
| D | 1 | 9 | - | - | - | - |
| E | 5 | 13** | 4/12 (33.3) | 0/12 (0.0) | 4/12 (33.3) | 0/12 (0.0) |

number of swabs from which S. suis was detected in the previous six months

* one pig died at two weeks with no autopsy performed

- not sampled

** only five piglets included in cohort study

TABLE 6.2

THE DETECTION OF S. SUIIS TYPE 1 IN NASAL AND VAGINAL SWABS
OF SOWS AFTER FARROWING

| SOW | SWAB | WEEKS AFTER FARROWING | | | | | | | |
|-----|---------|-----------------------|-----|---|-----|---|-----|---|---|
| | | 0 | 0.5 | 1 | 1.5 | 2 | 2.5 | 3 | 4 |
| A | Nasal | + | - | - | - | + | + | - | + |
| | Vaginal | - | - | + | - | - | + | - | - |
| B | Nasal | - | + | - | - | + | - | - | - |
| | Vaginal | - | - | - | - | - | - | - | - |
| C | Nasal | + | - | - | - | + | + | - | - |
| | Vaginal | - | - | - | - | - | - | - | - |
| D | Nasal | - | - | - | - | + | - | + | - |
| | Vaginal | - | - | - | - | - | - | - | - |
| E | Nasal | - | + | - | + | + | + | - | - |
| | Vaginal | - | - | - | - | - | - | - | - |

+ positive fluorescence
- no fluorescence

TABLE 6.3

THE DETECTION OF S. SUIIS TYPE 2 IN NASAL AND VAGINAL SWABS
OF SOWS AFTER FARROWING

| SOW | SWAB | WEEKS AFTER FARROWING | | | | | | | |
|-----|---------|-----------------------|-----|---|-----|---|-----|---|---|
| | | 0 | 0.5 | 1 | 1.5 | 2 | 2.5 | 3 | 4 |
| A | Nasal | - | + | - | + | + | - | - | + |
| | Vaginal | - | - | + | - | + | - | - | + |
| B | Nasal | - | - | - | + | + | - | + | - |
| | Vaginal | - | - | - | - | - | - | - | - |
| C | Nasal | - | + | - | + | - | + | - | - |
| | Vaginal | + | - | + | - | + | - | - | + |
| D | Nasal | - | + | - | + | - | - | - | - |
| | Vaginal | - | - | - | - | - | - | - | - |
| E | Nasal | + | - | - | - | + | - | + | - |
| | Vaginal | - | - | - | - | - | - | - | - |

+ positive fluorescence
- no fluorescence

FIGURE 6.2

THE TEMPORAL PATTERN OF INFECTION WITH S. SUIIS TYPE 1

FIGURE 6.3

THE TEMPORAL PATTERN OF INFECTION WITH S. SUIIS TYPE 2

Swabs of two of the pigs that were weaned to the isolation cages were negative for S. suis type 1 at weaning. Subsequently these pigs were detected as being infected two and 12 days after weaning. This latter animal was the last pig to be detected as infected with S. suis type 1. All piglets were infected with S. suis type 2 before weaning.

In Figure 6.4 the percentage of sucking pigs infected with S. suis types 1 and 2 is compared with the prevalence of infection in the isolated group. In the period of investigation, the mean prevalence rate for S. suis types 1 and 2 was 29.9% and 44.8% respectively for the isolated pigs and 34% and 47.6% for the conventionally reared pigs. There was no significant difference between the prevalence rate for S. suis type 1 ($p > 0.5$) or for S. suis type 2 ($p > 0.7$).

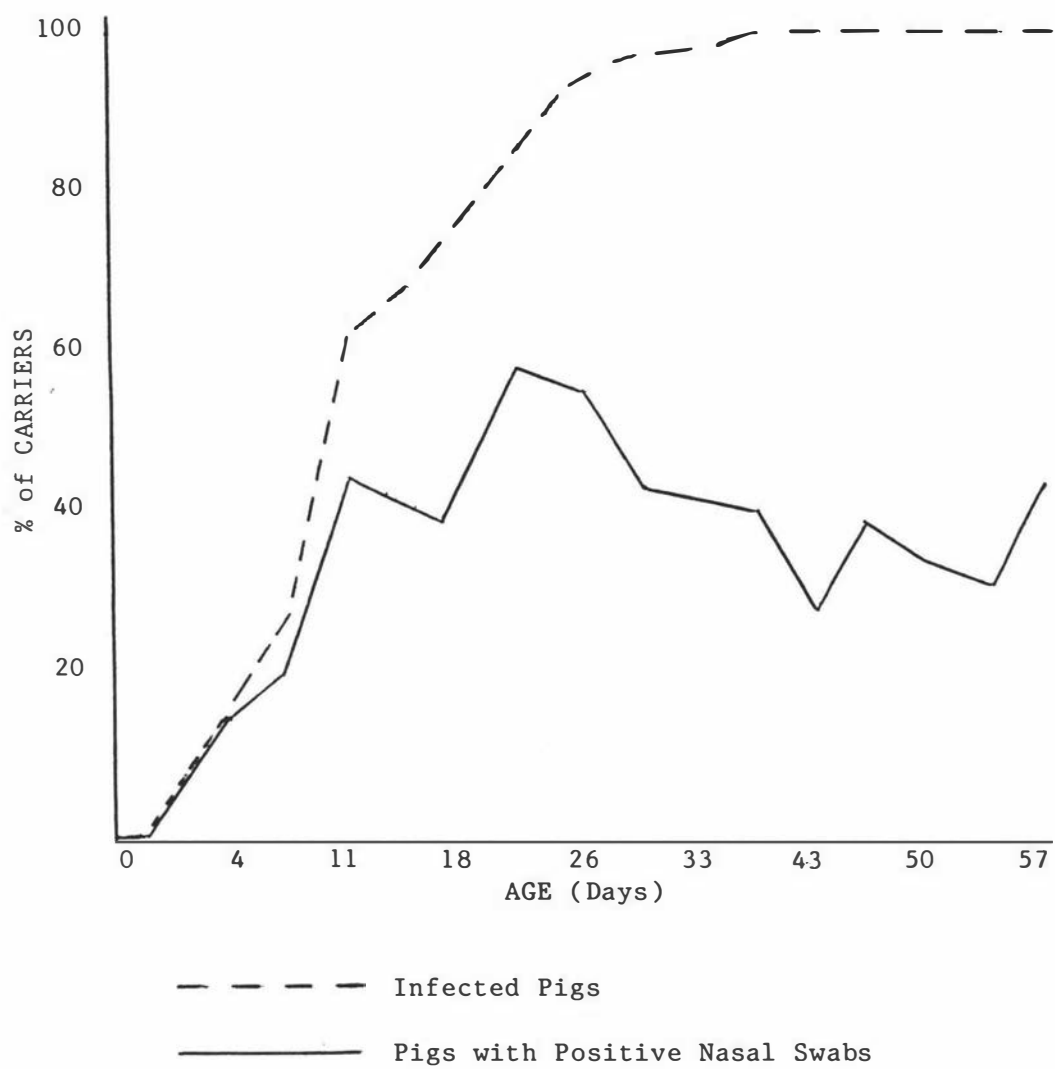
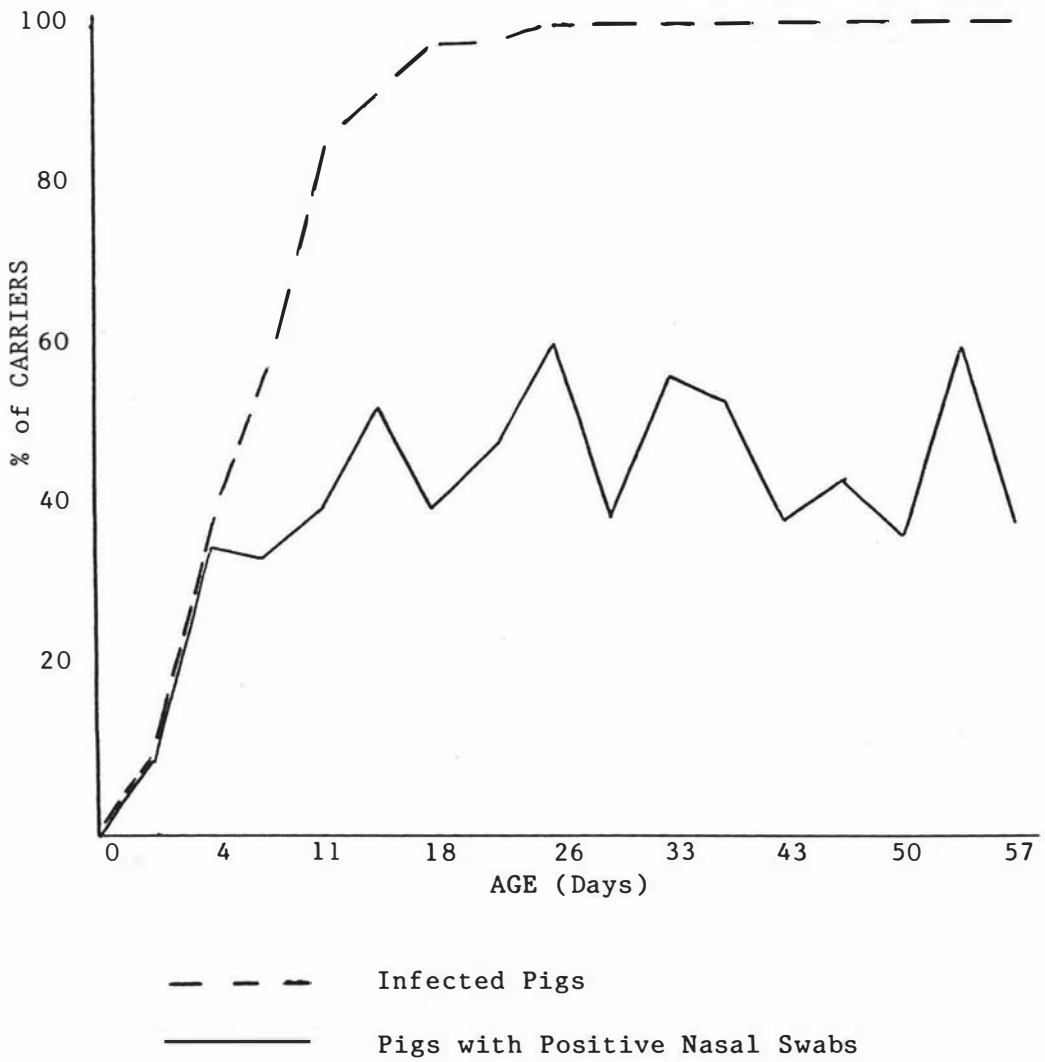
In Table 6.4 the mean ages of infection for S. suis types 1 and 2 are compared for both female and male pigs. There was no significant difference between the average age of infection in male and female pigs for S. suis type 1 ($p > 0.3$) and for S. suis type 2 ($p > 0.6$). However there was a significant difference between the age of infection for S. suis type 1 when compared with that of S. suis type 2 ($p < 0.01$) (13.5 days compared with 8.9 days).

Table 6.5 lists the results of an I.F.A.T. performed on the bacterial growth from samples collected from five week old pigs. Streptococcus suis type 2 was isolated from the kidney and liver of one pig and from the heart blood and the female reproductive tract of another. Streptococcus suis type 2 was also detected from nasal and tonsillar swabs of both these pigs. These two pigs were from the traditionally reared, unweaned group and appeared healthy prior to euthanasia. Streptococcus suis type 1 was detected in tonsillar swabs (40%) and nasal swabs (20%) but in no other samples.

One of the cohort pigs that died in the weaner shed, showed gross pathological changes of congested meninges and parenchymatous organs and severe purulent peritonitis and pleuritis. Coliforms, Proteus spp. and a few haemolytic streptococci were detected from the liver and from peritoneal and meningeal swabs. Smears of the bacterial growth from the meningeal swab, liver and tonsil were also positive for S. suis type 2, however S. suis type 1 was detected only from the

FIGURE 6.4

THE PROPORTION OF CARRIERS OF S. SUIIS TYPES 1 AND 2 IN PIGS
HOUSED UNDER DIFFERENT CONDITIONS

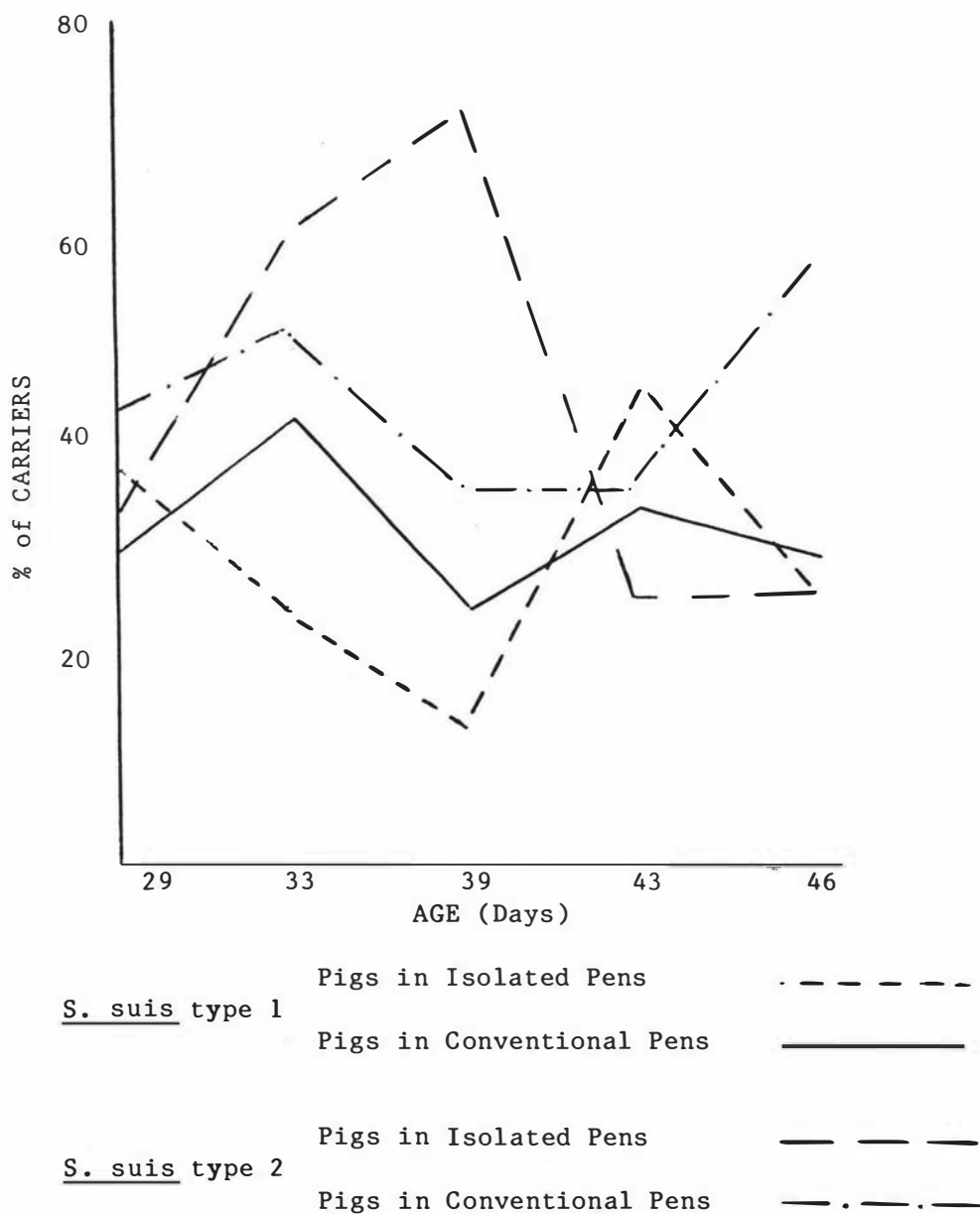

TABLE 6.4

THE MEAN AGE AT WHICH PIGS FIRST BECAME INFECTED WITH
S. SUIIS TYPES 1 AND 2

| | <u>S. SUIIS</u> TYPE 1 | | <u>S. SUIIS</u> TYPE 2 | |
|---------------|-----------------------------|-----------------------|-----------------------------|-----------------------|
| | Mean age of Infection | Standard Deviation | Mean age of Infection | Standard Deviation |
| MALE | 12.3* | 8.7 | 8.6# | 5.2 |
| FEMALE | 14.5* | 6.2 | 9.6# | 7.6 |
| BOTH SEXES | 13.5 _s | 7.5 | 8.9 _s | 6.2 |

* - No significant difference ($p > 0.3$)

- No significant difference ($p > 0.6$)

_s - Significant difference ($p < 0.01$)

TABLE 6.5

I.F.A.T. RESULTS FROM PIGLETS EXAMINED POST MORTEM

| SAMPLE | NUMBER OF PIGS | NUMBER POSITIVE FOR <u>S. SUIS</u> TYPE 1 (%) | NUMBER POSITIVE FOR <u>S. SUIS</u> TYPE 2 (%) |
|---------------------------|----------------|---|---|
| Tonsil | 10 | 5 (50) | 7 (70) |
| Nasal | 10 | 3 (30) | 5 (50) |
| Meninges | 10 | 0 (0) | 0 (0) |
| Brain | 10 | 0 (0) | 0 (0) |
| Heart Blood | 10 | 0 (0) | 1 (10) |
| Liver | 10 | 0 (0) | 1 (10) |
| Kidney | 10 | 0 (0) | 1 (10) |
| Female Reproductive Tract | 8 | 0 (0) | 1 (12.5) |

tonsil. This pig had shown signs of malaise for two days prior to death. The severe peritonitis was believed to have originated from a perforated rectum probably associated with the taking of a rectal swab by another worker investigating the gut flora of these pigs.

Environmental Isolation

Table 6.6 records the percentage of environmental swabs from which S. suis was isolated. The highest percentage of positive swabs was found in those taken from the feed-troughs of the weaner house. Of these, 7.1% were positive for S. suis type 1 and 14.2% for S. suis type 2. Fewer positive swabs were detected in the feed troughs of isolated pigs (4.7% and 7.9% for S. suis types 1 and 2 respectively) than from the troughs of the traditionally weaned pigs. Streptococcus suis types 1 and 2 were also detected more frequently in swabs taken from the floor of conventionally weaned pigs than from swabs of the floor of individually housed pigs. The feed troughs of sows A, C, D, and E all yielded one positive swab for S. suis type 2, however only the trough of sow E had a swab positive for S. suis type 1. When all pigs had been removed from the farrowing house and the pens had been hosed out, neither S. suis types 1 nor 2 could be isolated from swabs of the feed troughs and farrowing crates. Similarly, swabs taken from the floor of individually penned pigs were negative for both S. suis types 1 and 2 after all pigs had been transferred to the piggery and the pens had been washed.

Serological (ELISA) Results

Figures 6.5 and 6.6 plot the geometric mean and the range of titres to S. suis types 1 and 2 respectively for the five litters of cohort piglets between the age of one and six weeks. The antibody titre fell to the lowest level at three weeks of age for S. suis type 1 and at four weeks for S. suis type 2. After this period titres gradually increased for both S. suis types 1 and 2. Although the period of lowest titres for S. suis type 1 occurred in younger piglets, the mean age of infection for this type was older than that for S. suis type 2. As mentioned earlier, the time individual pigs were first identified as being infected with S. suis varied. This

TABLE 6.6

ISOLATION OF S. SUIS TYPES 1 AND 2 FROM THE ENVIRONMENT
OF THE STUDY PIGLETS

| SITE OF SWAB | NUMBER OF SWABS | NUMBER POSITIVE FOR <u>S. SUIS</u> TYPE 1 (%) | NUMBER POSITIVE FOR <u>S. SUIS</u> TYPE 2 (%) |
|---|-----------------|---|---|
| Sow Troughs Farrowing shed | 30 | 1 (3.3) | 2 (6.6) |
| Farrowing pen Mesh Floor | 40 | 1 (2.5) | 3 (7.5) |
| Slatted Floor of Individually Housed Pigs | 20 | 1 (5.0) | 1 (5.0) |
| Feed Troughs of Individually Housed Pigs | 63 | 3 (4.7) | 5 (7.9) |
| Solid Floor Weaning House | 14 | 0 (0.0) | 1 (7.1) |
| Slatted Floor Weaning House | 14 | 1 (7.1) | 1 (7.1) |
| Feed Troughs Weaning House | 14 | 1 (7.1) | 2 (14.2) |
| Dust Weaning House | 10 | 0 (0.0) | 0 (0.0) |
| Feed Troughs Growers | 8 | 0 (0.0) | 0 (0.0) |
| Solid Floor Growers | 16 | 0 (0.0) | 1 (6.3) |

FIGURE 6.5

INFECTION AND THE DEVELOPMENT OF ANTIBODIES TO S. SUIIS TYPE 1

FIGURE 6.6

INFECTION AND THE DEVELOPMENT OF ANTIBODIES TO S. SUIIS TYPE 2

○ Geometric Mean Titre

I Range of Titres

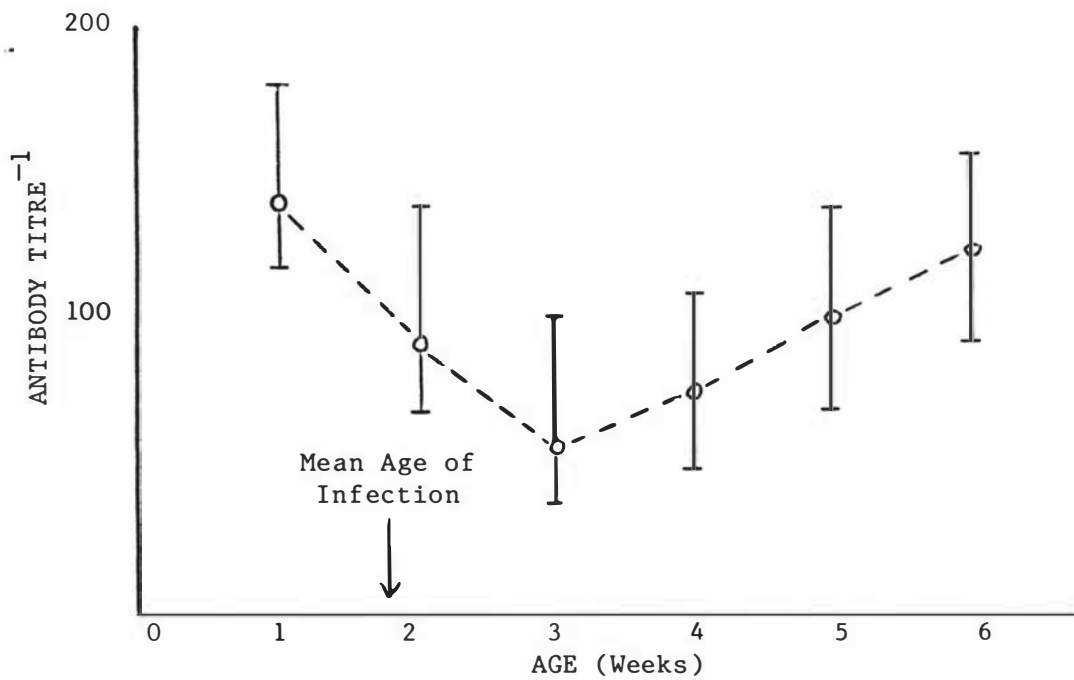
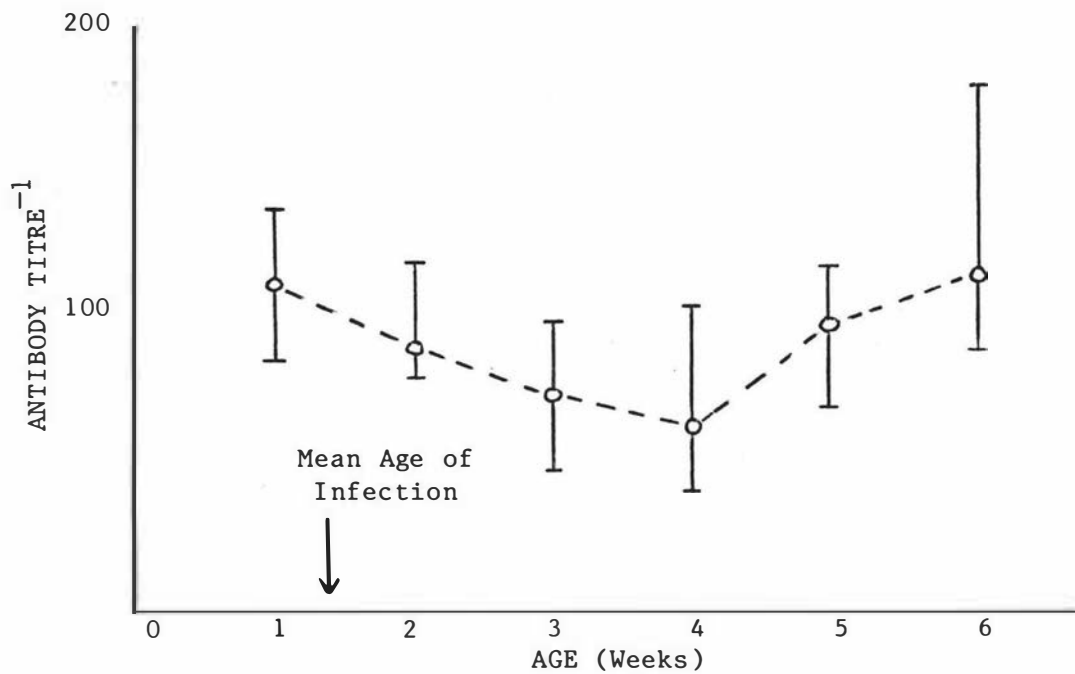
variation was associated with some pigs being detected as infected prior to the age when their titre was lowest and others being detected after this age. There was no apparent correlation between the time of first detectable infection and the titre, other than that most animals were detected as being infected prior to an increase in titre.

Figures 6.7 and 6.8 are graphs of the changes in the geometric mean and range of titres for S. suis types 1 and 2 respectively in the litter of pigs followed from birth to slaughter (22 weeks). Titres to S. suis types 1 and 2 were initially high at two days of age (1/200 and 1/180 respectively) and then fell to minimal levels (1/30 and 1/60 respectively) at similar ages to those recorded in the five cohort litters. The titres subsequently increased until the pigs were slaughtered. Concurrent cultural examination of this litter was not carried out.

DISCUSSION

Most investigations into the infection of pigs with S. suis type 2 have relied on data from cross-sectional surveys. These surveys only detect the prevalence of infection at one particular time and do not reveal the incidence of infection or the dynamics of infection within a herd. In the present study five litters, reared under natural conditions, were regularly sampled to investigate the spread of infection. Streptococcus suis type 2 was detected in the growth of nasal swabs from some one day old piglets in one litter. This litter was from a sow which previously had been shown to have S. suis type 2 present in the vagina. Similar findings were also reported in Chapter V. Streptococcus suis type 2 was not detected in nasal swabs collected from one day old piglets originating from sows without vaginal infections. However by the time these latter piglets were three days old, S. suis type 2 had been detected in at least one piglet from each litter. There was a more rapid spread of infection of S. suis type 2 in the litter from the vaginal carrier, as all piglets were infected by the age of seven days. Piglets from the other four litters were not all infected until 10, 15, 25 and 26 days post partum. If it is assumed that in fact all nine piglets from the vaginal carrier were infected at birth, then by using a test of only

FIGURE 6.7

CHANGE IN ANTIBODY TITRE TO S. SUIIS TYPE 1 IN A COHORT OF PIGS

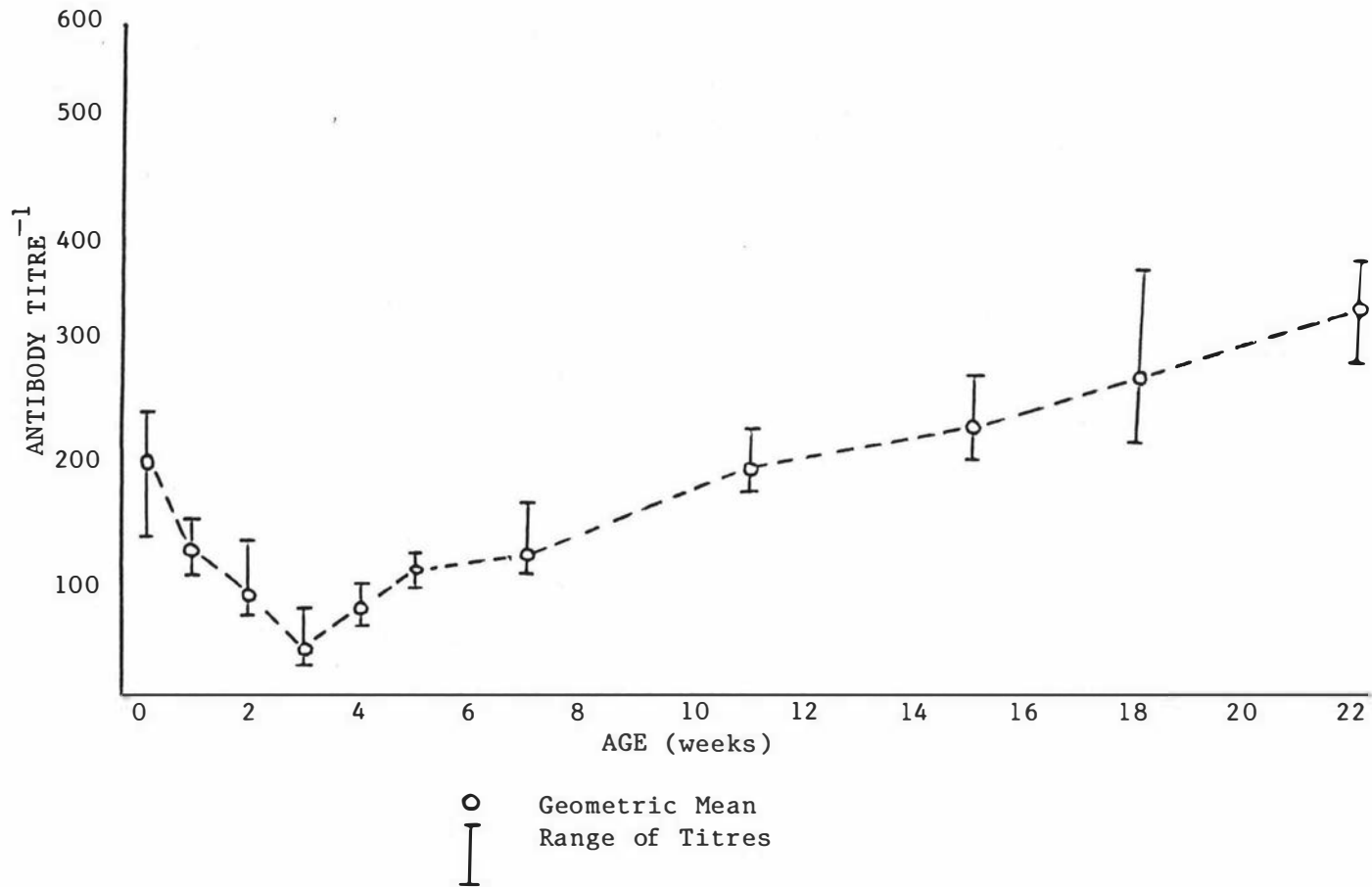
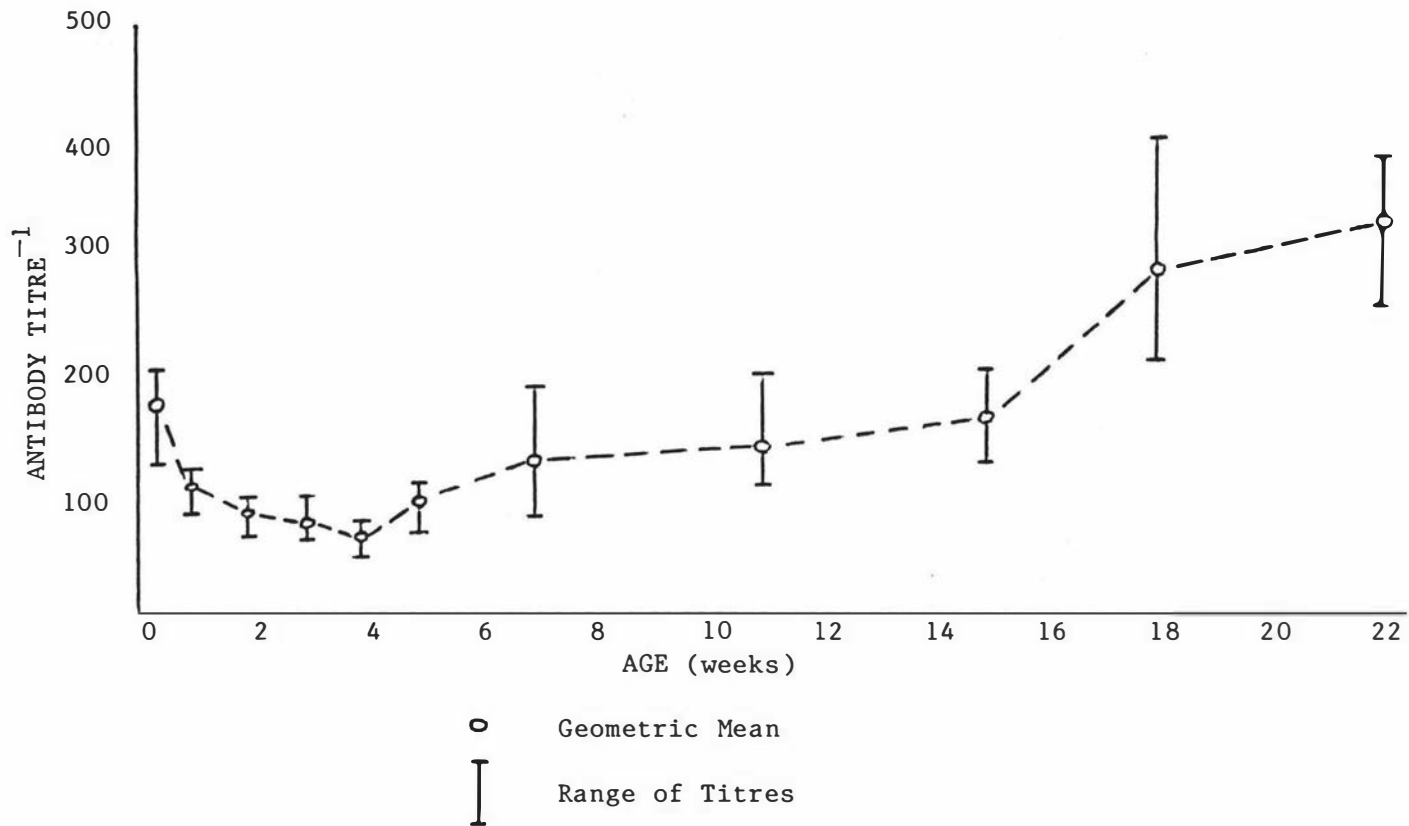

FIGURE 6.8

CHANGE IN ANTIBODY TITRE TO S. SUIIS TYPE 2 IN A LITTER OF PIGS



60% sensitivity, the chance of detecting only three infected piglets at one day of age, is only 1 in 10. Such a chance is within the realms of biological possibility. However if none were detected as being infected by this test, the chance of these results being false negatives drops to 1 in 5000. Thus it would appear that litters from non-vaginal carriers were not infected at birth and consequently negative on the first test unlike the litter from the vaginal carrier. Infection of the litter from the vaginal carrier may have been from mechanical contamination during passage through the vagina, from post-natal infection originating from either the vagina or oro-nasal pharynx of the sow, or most likely occurred in utero. If in utero infection does occur, there would be little value in performing hysterectomies on sows in an attempt to obtain uninfected piglets. In utero infection could account for the presence of infection in hysterectomy derived stock as reported by Lamont et al (1980). Hofferber (1952) believed in utero infection with streptococci was possible and considered this to be responsible for the deaths of piglets (eight days to three weeks old) with streptococcal endocarditis. The relationship between vaginal and uterine infection is reported and discussed further in the next chapter.

The sow with positive vaginal swabs for S. suis type 2 prior to farrowing, also had positive swabs after farrowing. One other sow (C - Table 6.3) had S. suis type 2 isolated from vaginal swabs only after farrowing. The presence of this organism in the vagina may have been associated with a descending uterine infection, a haematogenous infection or from an ascending infection originating either from the environment or from the piglets. However, as the organism was detected in the vagina before any of her piglets became infected, this infection could not have been of piglet origin. The farrowing shed was hosed and disinfected prior to the introduction of sows and S. suis was not detected in swabs of the environment taken prior to farrowing, therefore it seems unlikely that an ascending infection could originate from the environment. The most likely origin of the S. suis type 2 present in the vagina would have been from the uterus. If a uterine infection had been present at the time of parturition, then the relaxation of cervical musculature which occurs at this time may have allowed infection to pass into the vagina. The offspring of this sow were all infected by the age of ten days. This was the youngest age of infection other than for the litter from the persistent vaginal

carrier. However, unlike the litter from this latter sow, none of the piglets were infected before the age of three days. Although no S. suis type 1 was detected in vaginal swabs collected prior to farrowing, one sow was positive after farrowing. However unlike the sow with persistent vaginal infection by S. suis type 2, the offspring of this sow were not infected with S. suis type 1 on the first day of sampling. The first infected piglet from this litter was identified when the piglets were six days old. However in the other four litters, at least one piglet was found to be infected within three days of birth. These findings support evidence presented in previous chapters that S. suis types 1 and 2 are different in relation to the way in which pigs become infected. Vaginal or uterine spread of infection to piglets does not appear to occur with S. suis type 1 unlike that recorded with S. suis type 2.

All piglets from one litter were infected with S. suis type 1, by the age of 17 days, three litters were all infected by 21 days including the litter from the sow with a vaginal infection and all piglets in the final litter were infected by 38 days of age. If it is assumed that the sensitivity of the I.F.A.T. for detecting S. suis type 1 is 48% (Table 3.11) and that all pigs are infected, then the chance of having all false negative results is only 1 in 357. Thus it is reasonable to assume that no one-day old piglets were infected with S. suis type 1.

As reported in Chapter III, it was found that nasal swabbing was less sensitive for the detection of pigs infected with S. suis type 1 than with S. suis type 2. Therefore the apparent variation in the age of infection for S. suis types 1 and 2 may arise from the difference in the sensitivity of the I.F.A.T. for detecting these organisms.

Windsor (1977) believed that infected sows spread S. suis to their susceptible non-infected piglets. He considered that once infection by both S. suis types 1 and 2 was present in a litter, there was rapid spread of the organisms throughout the herd after the infected litter was weaned. However, in the present investigation it would appear that most litters have a 100% infection rate prior to weaning. In this case all animals would already be infected at weaning, although it is possible that reinfections could occur. The rapid spread of infection in a litter could be associated with the

frequent nose to nose contact that occurs both between sows and sucking piglets and between the piglets (Jeppesen, 1984). Watson and Bertram (1983) recorded that in a three hour period, between 10 and 30 naso-naso contacts occurred between nursing piglets and their mother.

Although the prevalence of infection with S. suis fluctuated in both the pigs reared under conventional conditions and those raised in isolated pens, there was no significant difference between the number of infected animals detected ($p > 0.5$ for S. suis type 1 and $p > 0.7$ for S. suis type 2). As most pigs were infected prior to weaning, the type of housing would not be expected to have any influence on the prevalence rate. Although pigs housed in groups would have a greater chance of becoming reinfected if this occurs. However, two pigs that were previously not infected with S. suis type 1 prior to weaning subsequently became infected two and 12 days after being transferred to the isolation pens. The last pig detected as infected with S. suis type 1 was 38 days old. This pig had been swabbed 10 times prior to this positive result. It is probable that this pig was infected prior to weaning but a combination of a test with low sensitivity and the shedding of few organisms produced results that were false negatives. The variation in the proportion of pigs detected as positive on each particular sampling day would be associated with the sensitivity of the test and the number of organisms present within the nasal cavities as discussed in Chapter III. Clifton-Hadley et al (1984b) also reported fluctuation in the infection status of individual pigs. They believed that S. suis type 2 persisted at undetectable levels deep in the tonsillar tissue with only periodic multiplication to a detectable level. If it is assumed that infection of the nose is a direct result of tonsillar infection and that intermittent shedding occurs, variations in the ability to detect organism within the nasal cavities would be expected.

As was demonstrated earlier in Chapter V, S. suis type 2 can be isolated from tissues other than the palatine tonsils of apparently healthy pigs. Streptococcus suis type 2 was detected in swabs from both the blood and female reproductive tract of one weaner pig. This finding supports the hypothesis of a haematogenous spread of infection. This is contrary to the findings reported in Chapter V, where no pigs smaller than bacon weight (six months old) were found to have either vaginal or uterine infection with S. suis type 2. If

infection of the reproductive tract can be of haematogenous origin it occurs only rarely, otherwise younger pigs, such as porkers, would have been found to be infected at the time of slaughter. Venereal transmission could obviously not have occurred in a piglet of this age. The detection of S. suis type 2 from the liver and kidney samples of another pig would also be compatible with haematogenous spread of infection. However no S. suis was identified in the blood of this pig. This was probably associated with a small number of organisms circulating in the blood and the small volume of blood collected. Although S. suis type 2 was isolated from the meninges of a dead weaner, it would appear that the primary cause of death was from peritonitis caused by a perforated rectum. In this situation S. suis type 2 may have been an opportunist secondary invader. This finding is interesting in that, as S. suis type 2 was detected in samples of this animal, it could have been incorrectly assumed to be the primary cause of disease, if the other lesions and organisms had not been considered.

As had been demonstrated in Chapter IV, S. suis types 1 and 2 were present in the environment of a piggery. The highest percentage of positive swabs for both S. suis types 1 and 2 were detected in those taken from the feed troughs in the conventional weaner house. In the individually housed pigs, S. suis type 2 was also detected most frequently in the feed troughs and for S. suis type 1 on the swabs of the slatted floor. Although more positive swabs were detected from the troughs of the weaning house than from the troughs of the isolated pigs, there was no significant difference ($p > 0.4$) between them for either S. suis types 1 or 2. The higher rate of detection of S. suis from the environment of the conventional weaner house, was probably associated with the greater number of pigs housed in this building. It would appear that the more pigs there are, the greater the chance of detecting S. suis in the environment. The high levels detected in swabs of the plastic feed troughs would be associated with the frequent feeding and nuzzling of the troughs by pigs. As S. suis is found in the tonsils and nasal cavities of pigs, saliva and nasal discharges are also likely to contain these organisms. Streptococcus suis was not isolated from the pens and troughs after hosing out. This is probably associated with a dilution factor from the water as reported by Clifton-Hadley and Enright (1984).

Clifton-Hadley et al (1984b) followed the spread of infection of S. suis type 2 in nine week old previously uninfected pigs. Unlike the present investigation, they did not study the natural spread of infection through a herd, but rather the artificial spread to non-infected pigs originating from another herd. However the results recorded were similar. In their experiment, five previously uninfected pigs became infected after between five and 25 days after contact with the infected pigs. Streptococcus suis type 2 was detected in nasal swabs from two pigs, seven and 12 days after mixing. However some pigs that were subsequently shown to have infected tonsils never had S. suis type 2 isolated from nasal swabs. In the present investigation, excluding the litter from the sow with a persistent vaginal infection, 36 piglets were detected as having positive nasal swabs between three and 26 days after birth and therefore contact with their infected mother. The detection of S. suis in some pigs earlier than that recorded by Clifton-Hadley et al (1984b) is likely to be due to the use of a more sensitive test.

The sera from the five cohort litters showed initially a high level of antibody to both S. suis types 1 and 2. The titre fell in the first three to four weeks of life and then gradually increased. The serological results obtained from the litter of nine pigs was almost identical to that of the five cohort litters. Although the former litter was not cultured, there is no apparent reason to believe the onset and pattern of infection with S. suis was any different to the litters examined in detail. The initial antibody would have been passively acquired from the sow via colostrum (Porter, 1975). Windsor (1977) proposed that a carrier sow will infect her litter but at the same time confer a passive immunity until the piglets develop their own active immunity. The subsequent decrease in titre corresponds with the catabolism of immunoglobulins. Tizard (1977) reported that the half-life of IgG, the major immunoglobulin present in the colostrum of pigs, was between 6.5 and 22.5 days. This period corresponds with the fall in titre demonstrated in the present study. The increase in titre in the present studies would coincide with a declining passive maternal antibody level and increased susceptibility to infection. This pattern in the level of antibody would support the belief that the ELISA was specific and measured antibody to S. suis.

The average age of first detectable nasal infection corresponded with the period of decreasing levels of antibody. Although titres to S. suis type 1 started to increase before those of S. suis type 2, the mean age of infection with S. suis type 2 was earlier than that for S. suis type 1. With S. suis type 1 there was a seven day lag phase between the mean age of infection and the increase in titre, however for S. suis type 2 this period was increased to approximately 18 days. This may indicate a difference between the actions of S. suis type 1 and S. suis type 2 for infecting piglets and the subsequent development of an immune response. The general rise in titre of antibody was similar for pigs that were first infected with S. suis prior to the time of the lowest titre, as well as those infected after this point. This finding would support the belief that most pigs are infected with S. suis before the age of three to four weeks. Therefore the pig that was first detected as being infected with S. suis type 1 at the age of 38 days would have had several false negative results before the first positive swab was detected.

CONCLUSIONS

1. Pigs raised under traditional conditions in an intensive piggery are all infected with S. suis by weaning (five weeks of age).
2. There is a faster spread of infection in the piglets of sows with vaginal swabs positive for S. suis type 2 than in piglets of non-vaginal carriers.
3. Early infection of piglets with S. suis type 2 may occur from in utero infection.
4. Vaginal carriers of S. suis type 1 do not produce piglets infected with S. suis type 1 earlier than piglets from non-vaginal carriers.
5. The proportion of carriers of S. suis in pigs is the same irrespective of their housing conditions or population density.
6. Streptococcus suis is more readily detected in the environment of a piggery in an area with a higher density of pigs.

7. Pigs become infected with S. suis type 2 earlier (8.5 days) than with S. suis type 1 (13.5 days).
8. Antibody to S. suis is transferred passively in the colostrum.
9. Antibody to S. suis is produced by pigs as they become infected by the organisms.
10. Antibodies to S. suis type 1 develop earlier than antibodies to S. suis type 2.
11. Antibodies to S. suis, detected by an ELISA, are not protective against infection with S. suis.

CHAPTER VII

EXPERIMENTAL INFECTION WITH STREPTOCOCCUS SUIS

INTRODUCTION

The present chapter presents the results of attempts to infect pigs and other animals with different isolates of S. suis types 1 and 2. It is believed these results can be used to explain some of the unanswered questions concerning the epidemiology of this intriguing disease. Many other workers have also carried out experiments on the artificial infection of pigs. Their work will be summarized before describing the results from the present study. The experiments reported in this chapter are basically of five types:

1. intravaginal and intrapreputial infection of bacon weight pigs with both S. suis types 1 and 2.
2. intranasal infection of two litters with S. suis types 1 and 2.
3. intravenous infection of weaned pigs with S. suis type 2.
4. subarachnoid infection of weaned pigs with S. suis type 2.
5. infection of mice, rats, guinea pigs and rabbits with S. suis.

PREVIOUS EXPERIMENTAL INFECTION OF PIGS WITH S. SUISInfection with S. suis type 1

Field et al (1954) performed one of the earliest experiments by infecting piglets with a culture of an alpha haemolytic streptococcus. This streptococcus, isolated from field cases of meningitis, was later shown to belong to Lancefield's group S (De Moor, 1963). Four pigs were infected with a 24 hour culture by the intravenous route. Five

days after inoculation, two of these pigs developed febrile reactions and one subsequently showed "classical" nervous signs. Group S streptococci were cultured from the brain and joints of this pig. Although the other febrile pig did not show nervous signs, group S streptococci were isolated from its brain, cerebro-spinal fluid and joints. Streptococci were also isolated from a joint of one of the apparently normal pigs, whilst none could be cultured from tissues of the other healthy pig. Two pigs were also inoculated subdurally with this field isolate. One developed signs of meningo-encephalitis similar to the field cases whilst the other showed only mild ataxia. Examination post mortem revealed a fibrino-purulent meningitis with streptococci being isolated from the brains of both pigs.

Zhelev et al (1960) used the intraperitoneal route to inoculate two piglets with a diplococcus. This organism had been isolated from piglets with a purulent meningo-encephalitis. Both piglets subsequently developed signs similar to those seen in field cases of the disease.

Elliot et al (1966) detected a streptococcal bacteraemia in all of the eight piglets (less than 11 days old) infected with S. suis type 1. These piglets were infected by either spraying their throats and noses with a 12 hour culture of S. suis type 1, or by feeding milk containing the centrifuged deposit of 100 ml of this culture. Four of these pigs subsequently died and S. suis type 1 was isolated from the brains of all clinically affected pigs. Two piglets dosed with a gelatin capsule containing S. suis type 1, failed to develop either clinical signs or a bacteraemia, however S. suis type 1 was isolated from the throat of one of these piglets. Older piglets (21 days) failed to develop clinical signs when infected by nasal and throat sprayings. Further experiments showed that S. suis type 1, isolated from the nose of a clinically normal sow, was capable of infecting piglets with the subsequent development of bacteraemia. As isolates without capsules were non-infective, these workers believed the invasiveness of S. suis type 1 was associated with the presence of a capsule. The serum of piglets, collected three to four weeks after infection with S. suis type 1, was shown to protect other piglets against infection with this organism. Piglets that received this serum did not develop a bacteraemia following artificial infection, however a bacteraemia developed in nine of eleven non-protected piglets.

Agarwal (1968; 1969a; 1969b) and Agarwal et al (1969) also demonstrated the protective nature of serum from "normal" sows. Of 14 piglets that received a subcutaneous injection of 20 ml of sow serum, only one developed a bacteraemia following artificial infection with S. suis type 1. However, ten of 14 piglets that did not receive the serum developed a bacteraemia after artificial infection. This bacteriostatic property of sow serum was neutralized by the addition of the purified capsular polysaccharide of S. suis type 1. Agarwal et al (1969) believed that this protective ability was from antibody directed specifically against the capsule of S. suis type 1. They proposed that this antibody belonged to the IgM class of immunoglobulins. The sera of most pigs reared under conventional conditions developed bacteriostatic activity against S. suis type 1 by the age of four weeks. However sera from hysterectomy derived, colostrum deprived piglets, reared in a "pathogen free" environment, had no bacteriostatic effect, even when collected from pigs which were six months old. Strojna et al (1978) similarly demonstrated that S. suis type 1, although pathogenic for three week old piglets, was non-pathogenic for older pigs. Non-capsulated strains of S. suis type 1 were susceptible to phagocytosis in vitro by piglet neutrophils without the addition of the protective sow serum, and it was assumed that these strains were non-infective (Agarwal et al, 1969)

Elliot et al (1966) found that when S. suis type 1 was sprayed into the nasopharynx of piglets, there was rapid invasion of the blood. However, most piglets continued to thrive even when more than 300 organisms per ml of blood could be detected for a period of up to three weeks. The disappearance of S. suis type 1 from the blood was believed to be associated with the development of active immunity. Susceptible piglets were protected against infection with S. suis type 1 after receiving sera from convalescent piglets.

In the experiment of Williams et al (1973) only one of four, ten day old piglets developed clinical signs of meningitis and arthritis after oral infection with S. suis type 1. Although this organism could be detected in the tonsils and submandibular lymph nodes of all piglets, bacteraemia was detected only in the piglet with clinical signs. This bacteraemia developed eleven days after infection with S. suis type 1 and was detected for nine days.

In an attempt to induce endocarditis in pigs, Cotchin and Hayward (1953) gave a single intravenous injection of streptococci to two, 14 week old pigs, and a series of eleven intravenous injections to another two pigs. Although the streptococcus could not be grouped with any of the antisera available at the time, the organism produced biochemical reactions similar to those now recognized for S. suis type 1. One of the pigs that received a single injection of more than 10^{10} streptococci, subsequently developed arthritis and a mitral valve endocarditis whilst the other pig showed only histological evidence of endocarditis. One of the pigs that received a series of injections also developed an arthritis whilst the other remained apparently normal. Hont and Banks (1944) also artificially produced streptococcal endocarditis in two pigs. They followed a regime of five intravenous injections using increasing doses of their streptococcal isolate. One pig lost weight and developed severe endocarditis of the atrio-ventricular valve whilst the other pig developed slight endo and pericarditis.

Infection with S. suis type 2

Windsor and Elliot (1975) reported the first clinical cases of infection with S. suis type 2 in pigs in Britain. They infected four, ten week old pigs by spraying a field isolate of S. suis type 2 into the pigs' throats and noses. Initially 10^6 organisms were administered followed by a further 10^9 organisms ten days later. Only one pig developed a meningitis and arthritis, five days after the second inoculation. Streptococcus suis type 2 was isolated from the heart blood, peritoneum, pericardium, brain and inflamed joints of this pig. Streptococcus suis type 2 was not cultured from the nasal cavities or throats of the three apparently normal pigs.

Friend and Sims (1978) reported difficulties in consistently reproducing disease in pigs after artificial infection with S. suis type 2. They could produce disease in three day old colostrum deprived piglets, by either tonsillar or intravenous inoculation. However, they were able to infect only one, three week old piglet reared under conventional conditions. Similarly Clausen (1980) and Pedersen (1983) reported difficulties in artificially producing disease with S. suis type 2. Clausen (1980) found that meningitis could only be produced by

subarachnoid inoculation. However, several pigs did develop a mild polyarthritis after intravenous infection. All three pigs that were infected by the subarachnoid route developed nervous signs 16 hours after infection. When two of these pigs were euthanased 20 hours after infection, there was histological evidence of meningitis, however the meningitis was not as severe as that found in field cases. The third pig recovered 40 hours after infection and subsequently remained apparently normal. Because of the difficulty in reproducing clinical disease, Clausen (1980) believed that other unknown factors, as well as infection with S. suis type 2, were involved in the development of disease.

Clifton-Hadley and Alexander (1980) infected 20 weaned pigs with S. suis type 2 by either the intranasal or intravenous route. Seven pigs developed clinical signs with four subsequently dying. At autopsy S. suis type 2 was only isolated from the tonsils of two pigs which had recovered from infection, and four healthy pigs. These six pigs had all developed opsonic antibodies to S. suis type 2. On the basis of these findings, they proposed that the tonsil may act as a carrier site for S. suis type 2 in the healthy pig.

Pedersen et al (1981) used the intradermal and subcutaneous routes to inoculate seven pigs with S. suis type 2 isolated from a human case of meningitis. All pigs developed a local inflammatory reaction, at the site of injection. This inflammatory reaction persisted for several days. One pig subsequently developed arthritis eight days after infection. When this pig was autopsied, four weeks after infection, the joints contained a copious, cloudy exudate. Streptococcus suis type 2 was cultured from one of these arthritic joints. No other pigs developed clinical signs or had lesions detectable at post mortem. However, two apparently healthy pigs repeatedly gave positive blood cultures of S. suis type 2. These bacteraemias developed seven and nine days after infection. Streptococcus suis type 2 was also cultured from the blood of three other pigs, 24 hours after infection.

Unlike other workers, Swe (1976) recorded more obvious pathological changes when 21 weaned pigs, aged between four and eight weeks, were infected with S. suis type 2. He used four different routes of inoculation and the results obtained are summarized in

Table 7.1. Clinical signs of meningitis, arthritis and septicaemia were detected in most conventionally reared pigs that were infected by the intravenous, intranasal or percutaneous routes. No disease was evident in pigs infected by the pharyngeal route. Clifton-Hadley and Alexander (1981) repeated these experiments, but were unable to reproduce the same level of disease as Swe (1976). Their results are listed in Table 7.2. The proportion of pigs that developed meningitis in the intranasally inoculated group was similar to that in the intravenously infected group. All pigs developed a septicaemia and subsequently an arthritis following intravenous infection. However, it was not stated if the reported "septicaemias" were clinically diseased animals or microbiologically detected bacteraemias in apparently normal pigs. These artificially induced bacteraemias persisted for between ten and 24 days. These findings indicated that meningitis did not necessarily occur even when S. suis type 2 was present in the blood in large numbers and for prolonged periods. Streptococcus suis type 2 was also isolated from the joints and cerebro-spinal fluid of experimentally infected pigs that did not have apparent clinical disease. The tonsils were infected with S. suis type 2 in 48% of the experimentally infected pigs. Most of these carriers also had developed opsonic antibodies against S. suis type 2. However, these antibodies did not appear to provide the same protection as similar antibodies against S. suis type 1. Hysterectomy derived, colostrum deprived piglets appeared more susceptible to disease from S. suis type 2 than did pigs reared under conventional conditions. In an attempt to determine the pathway of infection to the meninges, cultures of S. suis type 2 were deposited either in the anterior nares or in the region of the cribriform plate. Results indicated that there was no apparent difference in the onset of clinical disease from infection by either route. Intramuscular injections of a corticosteroid (beta methasone sodium phosphate) were administered to pigs infected with S. suis type 2 in an attempt to simulate stress or interfere with the immune defenses of the body. However, when these pigs were infected via the intranasal route none developed clinical disease (Clifton-Hadley, 1984).

In the United States, Shuman et al (1972) infected five hysterectomy derived, colostrum deprived pigs with group R streptococci by the intravenous route. They inoculated two doses of a culture containing 12.55×10^8 organisms at three day intervals. All

TABLE 7.1

SUMMARY OF TRANSMISSION EXPERIMENTS OF SWE (1976)

| INOCULATION ROUTE | NUMBER OF PIGS INOCULATED | NUMBER OF PIGS DEVELOPING DISEASE | | | TOTAL NUMBER AFFECTED |
|----------------------|------------------------------|-----------------------------------|-----------|------------|-----------------------------|
| | | SEPTICAEMIA | ARTHRITIS | MENINGITIS | |
| Intravenous | 10 | 8 | 8 | 7 | 8 |
| Intranasal | 3 | 2 | 1 | 3 | 3 |
| Castration Wounds | 4 | 2 | 3 | 2 | 3 |
| Intrapharyngeal | 4 | 0 | 0 | 0 | 0 |

TABLE 7.2

SUMMARY OF TRANSMISSION EXPERIMENTS OF CLIFTON-HADLEY AND ALEXANDER (1981)

| INOCULATION ROUTE | NUMBER OF PIGS INOCULATED | NUMBER OF PIGS DEVELOPING DISEASE | | | TOTAL NUMBER AFFECTED |
|---|------------------------------|-----------------------------------|-----------|------------|-----------------------------|
| | | SEPTICAEMIA | ARTHRITIS | MENINGITIS | |
| CONVENTIONAL PIGS | | | | | |
| Intranasal | 21 | 4 | 3 | 4 | 4 |
| Intravenous | 18 | 18 | 18 | 5 | 18 |
| HYSTERECTOMY DERIVED COLOSTRUM DEPRIVED PIGLETS | | | | | |
| Intranasal | 7 | 6 | 3 | 6 | 6 |

pigs showed reduced appetites, were listless and developed slight lameness in the first week after infection. Three pigs became more lame five weeks after inoculation. When these pigs were autopsied their joints contained an excess of thin cloudy synovial fluid from which group R streptococci were isolated. Prior to the experiment, group D streptococci had been detected in the tonsils, however on autopsy group R streptococci were also present. These findings differed significantly from those of Clifton-Hadley and Alexander (1984) who found that hysterectomy derived, colostrum deprived piglets appeared to be more susceptible to clinical disease following intravenous infection than did conventionally reared pigs. It is possible that the American strains of S. suis type 2 were of lower virulence than the strains used by the British workers.

Experimental infection with group R-S streptococci

Pedersen et al (1980, 1981) inoculated 35 specific pathogen free pigs with group RS streptococci (the streptococci with Lancefield extracts which react with antisera to both groups R and S). The eight to 15 week old pigs were inoculated (0.1 ml intradermally and 0.4 ml subcutaneously) with a culture at the end of its exponential growth phase. All pigs developed a local inflammatory reaction at the site of injection. One pig developed meningitis and died within two days of inoculation, whilst another nine developed arthritis. Four pigs were also found to have an endocarditis on examination post mortem. The pigs with arthritis had bacteraemias for between three and 33 days. However pigs with endocarditis repeatedly gave positive blood cultures for up to 50 days until the pigs were either killed or died. The group RS streptococci that were isolated from the blood of three pigs with endocarditis, lost its specific polysaccharide antigen. The workers considered this loss was important because of the impossibility in differentiating between streptococci belonging to groups R and RS on biochemical tests alone. Nine pigs were also inoculated by the intranasal route with one ml of group RS streptococci. Only one pig was affected, dying suddenly 36 hours after inoculation. This pig was found to have congestion of the meninges and group RS streptococci were isolated from most organs of the body.

The one common factor in most experiments involving the artificial infection of pigs with S. suis types 1, 2 or 1/2, has been the difficulty in consistently reproducing disease. The use of hysterectomy derived, colostrum deprived pigs has produced more repeatable results, however, these pigs are costly to produce and maintain. Most workers have found that subarachnoid and intravenous inoculation of S. suis produces clinical disease more frequently than does intranasal, subcutaneous or intradermal inoculations. From the results of these workers it would appear that other factors are involved, besides the presence of infection with S. suis, in the development of clinical disease.

ARTIFICIAL INFECTION OF THE REPRODUCTIVE TRACT

INTRODUCTION

In Chapter V it was shown that both S. suis types 1 and 2 could be isolated from the vaginas and uteri of female pigs slaughtered at the meatworks. However, only one isolate (S. suis type 2) was obtained from the male reproductive system. In Chapter VI it was shown that piglets from a vaginal carrier were infected with S. suis type 2 at an earlier age than piglets from non-vaginal carriers. These vaginal infections were believed to have originated from either uterine or haematogenous infections. The aim of this experiment was to determine if ascending genital infection of S. suis could occur.

MATERIALS AND METHODS

Pigs

Twenty-four pigs (12 males and females) were selected for infection with S. suis from five litters of herd 1. The selection was made on the basis that all pigs would be slaughtered four to five weeks after the start of the experiment. All pigs were identified by ear tags and housed in three pens. One pen contained eight other pigs, as well as the infected pigs. These pigs were used as non-infected

controls. All experimental pigs were handled in a similar manner to the rest of the pigs, except for the routine sampling as described below. Pigs were slaughtered in two batches four and five weeks after infection.

Sampling Technique

All pigs were sampled prior to the experiment and then at twice weekly intervals until they were slaughtered. A swab¹ was inserted approximately four cm into the vagina or prepuce of each pig and rotated on the mucosa. These swabs were returned to the laboratory within one hour of collection. They were plated onto sheep blood agar, incubated for 18 hours at 37°C and an I.F.A.T. for both S. suis types 1 and 2 was performed on the bacterial growth as described earlier.

At slaughter, the total female reproductive tract or both testes, epididymides and seminal vesicles were collected from the pigs. These were returned to the laboratory within two hours of collection. The external surface of the samples was flamed and incised with a sterile scalpel. Swabs were taken from the vagina, cervix, and both uteri or from both testes, epididymides and seminal vesicles. These were plated onto sheep blood agar and an I.F.A.T. performed on the bacterial growth.

Infection

Isolates of both S. suis types 1 and 2 were cultured from the tonsils of apparently healthy pigs originating from this herd. Cultures of these isolates were grown overnight in Todd Hewitt Broth. The number of organisms present in each ml of broth was determined by the technique described in Chapter IV. Pigs were randomly divided into two groups containing equal numbers of males and females and infected with either S. suis type 1 or 2. One ml of broth, containing either 6.4×10^9 S. suis type 1 or 3.5×10^{10} S. suis type 2, was infused into the vagina or prepuce. The broth was administered by a syringe with a piece of plastic tubing securely fitted over the hub. The tubing was inserted approximately four cm into the vagina or prepuce before the culture was deposited.

¹ Hospiswab, Medical Wire and Equipment Ltd, Corsham
Wiltshire England

RESULTS

Tables 7.3 and 7.4 record the isolation of S. suis types 1 and 2 respectively from vaginal and preputial swabs of live pigs as well as from samples of the reproductive tracts collected after slaughter. Streptococcus suis was not isolated from any preputial or vaginal swabs prior to artificial infection. Streptococcus suis was also not isolated from any of the testes, epididymides or seminal vesicles collected after slaughter. However prior to slaughter, S. suis type 1 had been detected in preputial swabs taken from five of the six pigs inoculated with this type and S. suis type 2 from all of the six pigs inoculated. There was no spread of infection to non-infected male pigs. At slaughter, S. suis type 1 was found in the vagina of only one of the six females inoculated with this type and was not isolated from the vaginas of any other pigs. Prior to slaughter S. suis type 1 had been detected in at least one of the vaginal swabs from five of the six pigs inoculated with this type. In the week before slaughter, only one of these six pigs was identified as having swabs positive for S. suis type 1. This pig was the one subsequently recorded as having a positive vaginal swab after slaughter. At slaughter, S. suis type 2 was detected in the vaginas of three of six pigs inoculated with this type as well as from one non-infected control. All six females inoculated with S. suis type 2 had previously yielded at least one positive vaginal swab for S. suis type 2. However, only the three pigs which were subsequently shown after slaughter to have infected vaginas, had positive vaginal swabs in the week before slaughter. The non-infected control gilt that was positive for S. suis type 2 at slaughter, was initially identified as being infected 15 days after her pen mates had been artificially infected. Streptococcus suis type 2 was also isolated from the vagina of this pig in the week prior to slaughter. Streptococcus suis was not found in any of the cervixes or uteri collected at slaughter. There were also no obvious body discharges from pigs of either sex during the period of experimentation.

DISCUSSION

In the present experiment, it must be considered whether the detection of S. suis in the vaginal and preputial swabs was an

TABLE 7.3

ISOLATION OF S. SUIS TYPE 1 FROM THE REPRODUCTIVE TRACT
OF ARTIFICIALLY INFECTED PIGS

| ANIMAL NUMBER | SEX | TYPE OF S.SUIS INOCULATED | I.F.A.T. ON VAGINAL/PREPUTIAL SWABS | | | | | | | | | I.F.A.T. ON SAMPLES COLLECTED AT THE MEATWORKS | | | | | |
|------------------|-----|---------------------------------|-------------------------------------|---|---|----|----|----|----|----|----|--|--------|--------|--------|---------------------|--------------|
| | | | 0 | 4 | 8 | 12 | 15 | 19 | 22 | 26 | 30 | VAGINA | CERVIX | UTERUS | TESTES | SEMINAL VESICLES | EPIDIDYMIDES |
| 1 | M | 1 | - | + | - | - | - | - | - | - | - | - | - | - | - | - | - |
| 2 | M | 1 | - | + | + | + | + | + | + | + | + | + | - | - | - | - | - |
| 3 | M | 1 | - | + | + | + | - | + | + | + | - | - | - | - | - | - | - |
| 4 | M | 1 | - | - | + | + | - | - | - | - | - | - | - | - | - | - | - |
| 5 | M | 1 | - | - | - | - | - | - | - | - | - | - | - | - | - | - | - |
| 6 | M | 1 | - | + | + | + | - | + | - | + | - | - | - | - | - | - | - |
| 7 | F | 1 | - | + | + | + | - | + | - | - | - | - | - | - | - | - | - |
| 8 | F | 1 | - | + | - | - | - | - | - | - | - | - | - | - | - | - | - |
| 9 | F | 1 | - | + | - | - | - | - | - | - | - | - | - | - | - | - | - |
| 10 | F | 1 | - | - | - | - | - | - | - | - | - | - | - | - | - | - | - |
| 11 | F | 1 | - | + | - | - | - | - | - | - | - | - | - | - | - | - | - |
| 12 | F | 1 | - | + | - | - | + | - | - | + | + | + | - | - | - | - | - |

(CONTINUED)

TABLE 7.3 (CONTINUED)

| ANIMAL NUMBER | SEX | TYPE OF <u>S.SUIS</u> INOCULATED | I.F.A.T. ON VAGINAL/PREPUTIAL SWABS | | | | | | | | | I.F.A.T. ON SAMPLES COLLECTED AT THE MEATWORKS | | | | | |
|------------------|-----|--|-------------------------------------|---|---|----|----|----|----|----|----|--|--------|--------|--------|---------------------|--------------|
| | | | 0 | 4 | 8 | 12 | 15 | 19 | 22 | 26 | 30 | VAGINA | CERVIX | UTERUS | TESTES | SEMINAL VESICLES | EPIDIDYMIDES |
| 13 | M | 2 | - | - | - | - | - | - | - | - | | | | | - | - | - |
| 14 | M | 2 | - | - | - | - | - | - | - | - | | | | | - | - | - |
| 15 | M | 2 | - | - | - | - | - | - | - | - | | | | | - | - | - |
| 16 | M | 2 | - | - | - | - | - | - | - | - | | | | | - | - | - |
| 17 | M | 2 | - | - | - | - | - | - | - | - | | | | | - | - | - |
| 18 | M | 2 | - | - | - | - | - | - | - | - | | | | | - | - | - |
| 19 | F | 2 | - | - | - | - | - | - | - | - | - | - | - | | | | |
| 20 | F | 2 | - | - | - | - | - | - | - | - | - | - | - | | | | |
| 21 | F | 2 | - | - | - | - | - | - | - | - | - | - | - | | | | |
| 22 | F | 2 | - | - | - | - | - | - | - | - | - | - | - | | | | |
| 23 | F | 2 | - | - | - | - | - | - | - | - | - | - | - | | | | |
| 24 | F | 2 | - | - | - | - | - | - | - | - | - | - | - | | | | |
| 25 | F | - | - | - | - | - | - | - | - | - | - | - | - | | | | |
| 26 | F | - | - | - | - | - | - | - | - | - | - | - | - | | | | |
| 27 | F | - | - | - | - | - | - | - | - | - | - | - | - | | | | |
| 28 | F | - | - | - | - | - | - | - | - | - | - | - | - | | | | |
| 29 | F | - | - | - | - | - | - | - | - | - | - | - | - | | | | |
| 30 | M | - | - | - | - | - | - | - | - | - | | | | | - | - | - |
| 31 | M | - | - | - | - | - | - | - | - | - | | | | | - | - | - |
| 32 | M | - | - | - | - | - | - | - | - | - | | | | | - | - | - |

TABLE 7.4

ISOLATION OF S. SUIS TYPE 2 FROM THE REPRODUCTIVE TRACT
OF ARTIFICIALLY INFECTED PIGS

| ANIMAL NUMBER | SEX | TYPE OF <u>S.SUIS</u> INOCULATED | I.F.A.T. ON VAGINAL/PREPUTIAL SWABS | | | | | | | | | I.F.A.T. ON SAMPLES COLLECTED AT THE MEATWORKS | | | | |
|------------------|-----|--|-------------------------------------|---|---|----|----|----|----|----|----|--|--------|--------|--------|---------------------|
| | | | 0 | 4 | 8 | 12 | 15 | 19 | 22 | 26 | 30 | VAGINA | CERVIX | UTERUS | TESTES | SEMINAL VESICLES |
| 1 | M | 1 | - | - | - | - | - | - | - | - | - | - | - | - | - | - |
| 2 | M | 1 | - | - | - | - | - | - | - | - | - | - | - | - | - | - |
| 3 | M | 1 | - | - | - | - | - | - | - | - | - | - | - | - | - | - |
| 4 | M | 1 | - | - | - | - | - | - | - | - | - | - | - | - | - | - |
| 5 | M | 1 | - | - | - | - | - | - | - | - | - | - | - | - | - | - |
| 6 | M | 1 | - | - | - | - | - | - | - | - | - | - | - | - | - | - |
| 7 | F | 1 | - | - | - | - | - | - | - | - | - | - | - | - | - | - |
| 8 | F | 1 | - | - | - | - | - | - | - | - | - | - | - | - | - | - |
| 9 | F | 1 | - | - | - | - | - | - | - | - | - | - | - | - | - | - |
| 10 | F | 1 | - | - | - | - | - | - | - | - | - | - | - | - | - | - |
| 11 | F | 1 | - | - | - | - | - | - | - | - | - | - | - | - | - | - |
| 12 | F | 1 | - | - | - | - | - | - | - | - | - | - | - | - | - | - |

(CONTINUED)

TABLE 7.4 (CONTINUED)

| ANIMAL NUMBER | SEX | TYPE OF S.SUIS INOCULATED | I.F.A.T. ON VAGINAL/PREPUTIAL SWABS | | | | | | | | | I.F.A.T. ON SAMPLES COLLECTED AT THE MEATWORKS | | | | | |
|------------------|-----|---------------------------------|-------------------------------------|---|---|----|----|----|----|----|----|--|--------|--------|--------|---------------------|--------------|
| | | | 0 | 4 | 8 | 12 | 15 | 19 | 22 | 26 | 30 | VAGINA | CERVIX | UTERUS | TESTES | SEMINAL VESICLES | EPIDIDYMIDES |
| 13 | M | 2 | - | + | - | - | - | - | - | - | - | - | - | - | - | - | - |
| 14 | M | 2 | - | + | + | + | + | + | + | + | + | + | - | - | - | - | - |
| 15 | M | 2 | - | + | + | + | + | - | + | + | + | - | - | - | - | - | - |
| 16 | M | 2 | - | + | + | - | - | - | - | - | - | - | - | - | - | - | - |
| 17 | M | 2 | - | + | - | + | + | + | + | + | - | - | - | - | - | - | - |
| 18 | M | 2 | - | + | + | - | - | + | - | - | - | - | - | - | - | - | - |
| 19 | F | 2 | - | + | + | - | - | - | - | - | - | - | - | - | - | - | - |
| 20 | F | 2 | - | + | - | + | - | + | - | - | - | - | - | - | - | - | - |
| 21 | F | 2 | - | - | + | - | - | - | - | - | - | - | - | - | - | - | - |
| 22 | F | 2 | - | + | + | + | + | + | + | + | + | + | - | - | - | - | - |
| 23 | F | 2 | - | + | + | - | - | + | + | + | - | + | - | - | - | - | - |
| 24 | F | 2 | - | + | + | + | - | + | + | - | + | + | - | - | - | - | - |
| 25 | F | - | - | - | - | - | + | - | - | + | - | + | - | - | - | - | - |
| 26 | F | - | - | - | - | - | - | - | - | - | - | - | - | - | - | - | - |
| 27 | F | - | - | - | - | - | - | - | - | - | - | - | - | - | - | - | - |
| 28 | F | - | - | - | - | - | - | - | - | - | - | - | - | - | - | - | - |
| 29 | F | - | - | - | - | - | - | - | - | - | - | - | - | - | - | - | - |
| 30 | M | - | - | - | - | - | - | - | - | - | - | - | - | - | - | - | - |
| 31 | M | - | - | - | - | - | - | - | - | - | - | - | - | - | - | - | - |
| 32 | M | - | - | - | - | - | - | - | - | - | - | - | - | - | - | - | - |

indication of a true infection in which multiplication of the organism occurred, or purely its persistence from the initial inoculum. In Chapter IV it was found that S. suis survived in vitro for up to five days in a solution of physiological saline maintained at 37°C. In the present experiment, the swabs from six animals (four males and two females) were detected as positive for S. suis type 1, and the swabs of 11 animals (five males and six females) positive for S. suis type 2 for more than five days after the inoculation procedure. Due to the presence of viable S. suis in the vagina and prepuce for periods longer than was demonstrated in the in vitro studies, it was concluded that S. suis was "infecting" these organs.

In the present experiment, S. suis could not be identified in vaginal or preputial swabs collected from 32 pigs prior to inoculation. These findings agree with those recorded in Chapter V where no S. suis were found in vaginal swabs collected from bacon weight pigs or from any preputial swabs. Of the 12 pigs inoculated with S. suis type 1, 10 (83.3%) produced positive swabs for this type, and of 12 pigs infected with S. suis type 2 all subsequently gave at least one positive swab for this type. No S. suis were detected in samples of the male reproductive tract (testes, epididymides and seminal vesicles) even when preputial swabs had been positive on the day prior to slaughter. However after slaughter S. suis were detected in some vaginas, but not from any cervixes or uteri. Therefore in this investigation there was no evidence of ascending infection of S. suis from the vagina to the uterus or from the prepuce to the testes. However, in Chapter V no bacon weight pigs were found to have uteri infected with S. suis. Infection of the uterus may be via a haematogenous route or if it is via an ascending infection it may not occur until the animal farrows or has had several oestrus cycles. During ovulation and farrowing there is relaxation of the musculature of the reproductive tract and therefore there would be a greater chance for ascending infection to occur. One female control pig also had S. suis type 2 isolated from the vagina, two weeks after inoculation of her pen mates. This may have been caused by mating or being mounted by an artificially infected male. There was no evidence of an ascending infection in the males, therefore if venereal transmission of S. suis occurs, the boar probably acts purely as a mechanical transmitter. These findings are compatible with those reported in Chapter V.

As there were no obvious discharges or clinical illness seen in these infected pigs or those identified in Chapter V, it would appear that S. suis can be carried in the reproductive tract without causing disease. In this respect this carrier site may be similar to the palatine tonsil. However in retrospect, histological sections of the infected and non-infected reproductive tracts should have been examined to see if there were any histopathological abnormalities. Yurukov and Ganovski (1981) and Jones (1966, 1976b) also found that streptococci could frequently be isolated from the genital tract of adult female pigs. Koppang and Filseth (1958) isolated streptococci from the semen of ten boars examined and Jones (1976b) found that streptococci could be cultured from 20% of the pre-sperm fractions of the ejaculates of boars. However neither of these workers specifically identified S. suis in their samples. The isolation of S. suis from the normal reproductive tract may not necessarily imply the organisms involvement in a disease process, but rather its presence as a commensal. The present results would seriously question the validity of the findings of Sanford *et al* (1982) and Sala *et al* (1982) who isolated S. suis from cases of vaginitis, endometritis and infertility and believed this organism was the cause of these conditions. Swann and Kjar (1980) reported that streptococci could be isolated from a high percentage of breeding sows experiencing infertility and abortions. However they demonstrated that there was no significant difference between the number of live and dead piglets born to infected or non-infected sows. This finding is compatible with the findings of the present experiment, where S. suis was isolated from healthy sows and gilts. Preputial cultures by Swann and Kjar (1980) indicated that 75% of boars were infected with haemolytic streptococci. Although these authors did not use antisera for groups R and S streptococci in their grouping procedure, it is possible that members of these groups could have been present as 41% of their isolates could not be grouped with antisera from the streptococcal groups A to H, K, L, N, and O.

In a herd with serious preweaning losses from streptococcal septicaemia, Maclean and Thomas (1974) demonstrated an increase in the number of farrowing sows carrying alpha haemolytic streptococci in their vaginas. Although it would appear that vaginal infection of S. suis can lead to clinical disease, the interpretation of such an

isolation from a "diseased" reproductive tract should be treated cautiously.

CONCLUSIONS

1. Ascending infection of S. suis from the vagina to the uterus does not occur in female bacon weight pigs. However, cross infection of S. suis type 2 from pigs with infected vaginas or prepuces to the vagina of a non-infected female is possible.
2. Infection of the prepuce with S. suis does not lead to infection of other organs of the male reproductive tract, and the male pig does not appear to play an important role in venereal transmission of S. suis.
3. Infection of the reproductive tract with S. suis does not produce gross pathological changes. Streptococcus suis would appear to act as a commensal organism in this site and therefore the association of this organism with diseased or abnormal reproductive tracts does not imply causation.

INTRANASAL INFECTION OF PIGLETS

INTRODUCTION

Many experiments have been performed to investigate the pathogenicity of S. suis when inoculated intranasally into pigs. However, there have been few studies on the infectivity of this organism for pigs. The aim of this experiment was to investigate the infectivity and possible pathogenicity of field isolates of S. suis when administered intranasally to piglets in two litters. Daily nasal swabs and blood samples were collected to follow the spread of infection throughout the litters. This experiment was conducted conjointly with Mr Z.F. Fu who concurrently investigated the spread of rota virus in these litters.

MATERIALS AND METHODS

Sows

Two breeding sows were selected from Herd 1 (Chapter V) on the basis that both would farrow at similar times. Vaginal, nasal and rectal swabs had been collected from these sows at two-weekly intervals in the six month period prior to their selection. Further swabs were collected daily in the period from one week prior to farrowing to one week after farrowing. Milk, colostrum and swabs of the skin around the teat were also collected after farrowing. One week before the expected farrowing date, the sows were washed and thoroughly scrubbed with soap and water and disinfected with Savlon². This cleaning procedure was performed to remove external dirt and faeces in an attempt to have sows free from externally carried rota virus. It was not aimed at removing or destroying streptococci, if present, from the skin or body of the sow. After disinfection, the sows were transported to an isolation unit approximately one km from the piggery. This building had been vacant for the previous six months and prior to this had housed sheep. Before the sows arrived, the isolation unit was washed and hosed with water and disinfected with Multikleen³. After disinfection, the unit was closed up and fumigated with formaldehyde vapour produced by heating a 37% solution of formalin. Swabs of the floor and walls were taken after fumigation but before the arrival of the sows.

The sows were housed in individual pens approximately three metres square with a vacant pen between sows. Sows were fed on the floor and had a metal trough filled with water for drinking. Heaters were installed in the unit to raise the ambient temperature to approximately 22°C. When the sows farrowed, extra heaters were installed to provide warmth for the piglets. A partitioned off zone was constructed to provide the piglets with a safe sleeping area away from the sow.

² ICI Tasman, ICI NZ Limited, Upper Hutt, New Zealand

³ KW Products Ltd, Auckland

Piglets

The number of piglets, date of farrowing and sex of each piglet were recorded. Each piglet was identified by a consecutively numbered ear tag inserted when the piglets were three days old. Different coloured tags were used for each litter (orange for litter 1 and red for litter 2). Prior to ear tagging, pigs were identified by a number written in indelible ink on their sides. At three days of age the piglets had their tails docked, incisor teeth clipped and were injected with one ml of a Vitamin B12/iron complex⁴. When the piglets were one week old, creep feed was provided in a plastic trough. For the first two weeks of life, swabs⁵ were collected daily from both nasal chambers of the piglets. Blood samples were also collected daily from the cephalic vein until the pigs were eight weeks old. When the piglets were four and a half weeks old they were weaned and the sows returned to the herd of origin. After weaning, the two litters were housed together and remained in the isolation unit until they reached the age of eight weeks.

Infection

When the piglets were one day old, two piglets from litter 1 were inoculated with 5.5×10^9 organisms of S. suis type 2 and two others with 12×10^9 organisms of S. suis type 1. Nasal swabs and blood samples had been collected from all piglets prior to inoculation. The strains used for the experiment had been isolated from the palatine tonsils of apparently healthy pigs from this herd. The organisms were grown overnight in a Todd Hewitt Broth and enumerated by the technique described in Chapter IV. A 0.5 ml volume of this broth was infused into the right nostril using a syringe and a 25 gauge needle with plastic tubing placed snugly over the needle. The tubing was advanced approximately one cm into the nasal cavity prior to inoculation.

At two days of age, two piglets in litter 2 were inoculated with approximately 100 organisms of S. suis type 2 and two other piglets with approximately 80 organisms of S. suis type 1. The initial broth

⁴ Rubrafer Improved, E.R.Squibb and Sons (NZ) Ltd,
Auckland

⁵ Medical Wire and Equipment Ltd, Corsham, Wiltshire,
England

culture was diluted in physiological saline to obtain the required number of organisms. These piglets were also inoculated via the intranasal route as described above.

Samples

All swabs were cultured onto sheep blood agar and an I.F.A.T. performed on the primary growth as described in Chapter III.

Each day, 0.5 ml of blood was collected from each piglet and dispensed into universal bottles containing 10 ml of sterile Todd Hewitt Broth. This blood-broth suspension was incubated for 18 hours at 37°C and an I.F.A.T. performed on any bacterial growth.

Piglets that died or were born dead were submitted to an autopsy and microbiological examination.

RESULTS

No S. suis were isolated from vaginal and rectal swabs collected from sows in the six month period prior to farrowing. In this period, S. suis type 1 had been detected in 33% and 50% of the twelve nasal swabs collected from both sows and S. suis type 2 in 50% and 66%. After farrowing, S. suis type 1 was detected in 43% and 57% of the nasal swabs and S. suis type 2 in 57% and 71%. No S. suis were detected in swabs of the teat skin collected one week before farrowing. However in the week following parturition, S. suis type 1 was detected in 14% of the swabs of the teat skin from one sow. Streptococcus suis type 2 was also detected in 14% and 28% of the swabs of the two sows in this period. Streptococcus suis type 2 was detected in only one sample of colostrum.

Before sows were introduced, 24 swabs of the floor and walls were negative for both S. suis types 1 and 2. Swabs collected after the sows had arrived but before they had farrowed, were also negative. However after parturition, S. suis type 1 was detected in 4% and S. suis type 2 in 5.5% of 72 swabs collected from the pens housing the pigs. Streptococcus suis type 1 was detected in 6% and S. suis type 2

in 9% of 32 swabs taken from the rim of the water trough. Both organisms had been detected on the trough before and after farrowing.

In Figure 7.1 the spread of the detectable infection of S. suis types 1 and 2 is recorded for the litter containing the piglets infected with a high dose of organisms. All swabs collected before artificial infection were negative for both S. suis types 1 and 2. However, after infection of two piglets with over 10^9 organisms of S. suis type 1 and a different two with a similar number of S. suis type 2, there was rapid spread of infection through the litter. One day after artificial infection, 88% (8/9) and 78% (7/9) of pigs were found to be infected with S. suis types 1 and 2 respectively. Two days after infection, all piglets had recorded at least one positive nasal swab for both S. suis types 1 and 2. The lower curves in Figure 7.1 represent the percentage of positive swabs (both nostrils were sampled in all piglets) on each sampling day. In the first two days after inoculation, there was a sudden rise in the percentage of positive swabs to 72% (13/18) and 88% (16/18) for S. suis types 1 and 2 respectively. This was followed by a decrease in the percentage of positive swabs to a more constant level of between the 30 and 60 percentile range, seven days after infection.

Figure 7.2 is a graph of the spread of infection through the second litter after two piglets received approximately 100 organisms of S. suis type 2 and another two piglets approximately 80 organisms of S. suis type 1. In this litter there were also no positive nasal swabs before artificial infection. After inoculation there was a sharp rise in the percentage of infected piglets, so that one day after infection 82% (10/11) and 64% (7/11) were infected with S. suis types 1 and 2 respectively. However, these levels were not as high as those detected in the litter receiving the high dose. Two days after infection, all pigs in the litter had at least one positive swab for S. suis type 2 and all had one swab positive for S. suis type 1 three days after infection. The percentage of swabs positive for S. suis types 1 and 2 rose to the highest levels of 68% (15/22) and 64% (14/22) respectively two days after infection. The proportion of positive swabs then stabilized in the 30 to 60 percent range.

Four pigs from the litter infected with the high dose and three from the litter receiving the low dose developed a bacteraemia of

FIGURE 7.1

SPREAD OF INFECTION OF S. SUIIS TYPES 1 AND 2 IN A LITTER

INTRANASALLY INFECTED WITH 10^9 ORGANISMS

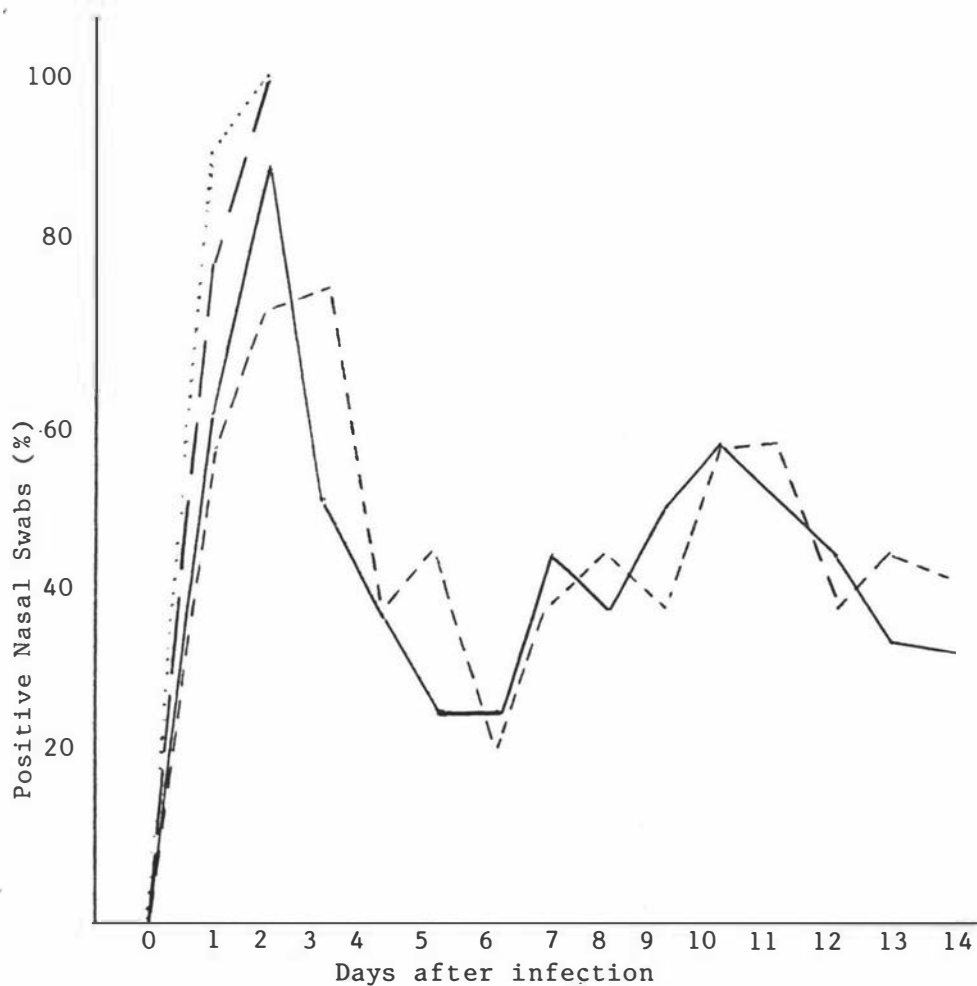

% Swabs Positive
at each Test

S. suis type 1

S. suis type 2

—————

% Infected Pigs

S. suis type 1

.....

S. suis type 2

—————

FIGURE 7.2

SPREAD OF INFECTION OF S. SUIIS TYPES 1 AND 2 IN A LITTER

INTRANASALLY INFECTED WITH 100 ORGANISMS

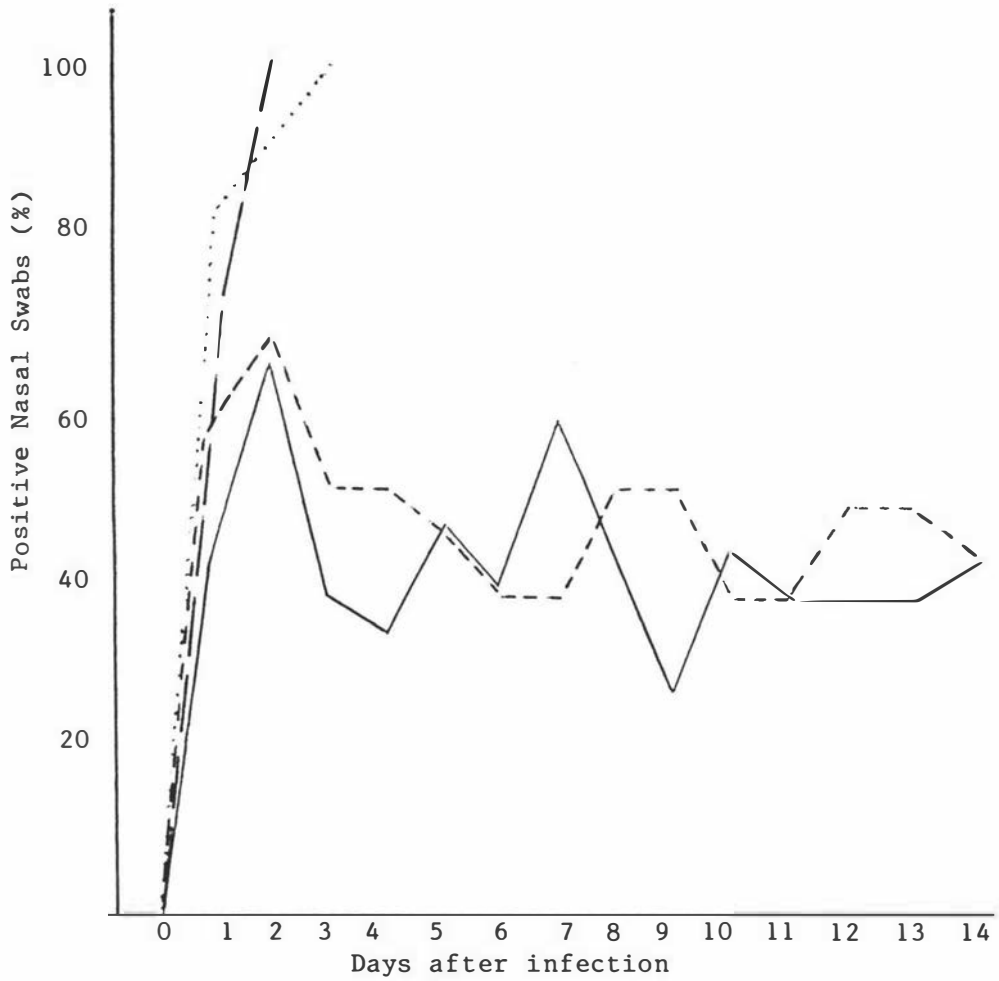

| | | |
|-------------------------------|-----------------------|-------|
| % Swabs Positive at each Test | <u>S. suis</u> type 1 | ----- |
| | <u>S. suis</u> type 2 | ————— |
| % Infected Pigs | <u>S. suis</u> type 1 | |
| | <u>S. suis</u> type 2 | ————— |

S. suis type 2. Two of these bacteraemias persisted for two days whilst the rest were detected for only one day. Thirteen pigs were not detected as having a bacteraemia of S. suis type 2 during the eight weeks of sampling. Two pigs from the litter receiving the high dose, and three from the litter infected with the low dose, developed a bacteraemia of S. suis type 1. Three of these bacteraemias were detected for only one day whilst the other two persisted for two and three days. Fifteen piglets did not have a detectable bacteraemia of S. suis type 1 during the period of sampling. All bacteraemias of S. suis type 1 were detected in the first eight days of the pigs life (within one week of artificial intranasal infection) whilst the bacteraemias to S. suis type 2 were distributed over the eight weeks.

Two dead, full term piglets and one mummified foetus were found after the sows had farrowed. The full term piglets were born dead as the lungs had not inflated. Streptococcus suis types 1 and 2 were not detected in swabs of the body organs of these three pigs. Two, one day old piglets were also found dead. These piglets had sucked and had extensive haemorrhages throughout the body which were probably caused from overlaying by the sow. Streptococcus suis was not isolated from any swabs of the body organs. Another piglet subsequently died at the age of four days old. This piglet was a litter mate to the piglets infected with the high dose of S. suis. The palatine tonsils of this piglet were infected with both S. suis types 1 and 2. Nasal swabs, collected in the two days prior to death, had also been positive for S. suis types 1 and 2. Streptococcus suis was not detected in any of the other organs cultured. The cause of death in this pig was again believed to be overlaying by the sow.

DISCUSSION

The results of these experiments are similar to the findings of other workers (Friend and Sims, 1978; Clifton-Hadley and Alexander, 1981) in that they illustrate the difficulty of producing clinical disease in pigs after artificial infection with S. suis. Although no clinical disease was produced, it was evident that when only a few pigs in a litter were intranasally inoculated with S. suis, there was rapid spread of infection to the other piglets of the litter. There was a slightly faster spread of infection in the litter receiving a

high dose of S. suis (10^9 organisms) than in the litter receiving a low dose (10^2 organisms). However, the spread of infection in the litter receiving the low dose was still faster than that recorded in a naturally infected litter. In Chapter VI, 100% of pigs were naturally infected with S. suis types 1 and 2 by the age of 38 and 26 days respectively. However in the present experiment, piglets in the litter receiving a high dose of S. suis types 1 and 2 were all infected by three days of age and piglets in a litter receiving a low dose were all infected by four and three days of age with S. suis types 1 and 2 respectively. These results would indicate that the minimum infective dose for S. suis, when administered by the intranasal route, is less than 100 organisms. The rapid spread of infection between piglets can again be explained by the frequent nasal contact both between piglets and between piglets and sows (Watson and Bertram, 1982).

Clifton-Hadley et al (1984b) reported the spread of S. suis type 2 from naturally infected pigs to non-infected pigs within five days of mixing the two groups. However, they identified infected pigs by the detection of organisms in the palatine tonsils and not in the nose as was done here. In the present experiment, the faster spread of infection may have been associated with the inoculation of piglets with a dose of organisms far in excess of the minimum infective dose, or from the rapid multiplication and colonization of the nasal cavities with organisms in previously uninfected piglets. It is possible that piglets which had positive nasal swabs after one day of contact with artificially infected pigs, may not have had infected tonsils. In the present experiment, it is likely that ascending infection of the tonsils from the nose occurred rather than the "typical" descending infection of the nose from the tonsil. There was a greater proportion of pigs with positive swabs in the first four days after infection in the litter that received the high dose, than in the group that received the low dose. However one week after infection, the proportion of positive swabs was similar in both litters. After artificial infection, there was probably an abnormally large number of organisms present. This number would then have reduced to a level which was "normally" present in a naturally infected animal. The subsequent minor fluctuations in the prevalence of infection were probably associated with the sensitivity of the test and the number of organisms shed into the nasal cavity as discussed earlier in Chapter III.

Streptococcus suis was not detected in the environment prior to the introduction of pigs. Only after the sows were introduced and had farrowed was S. suis detected from environmental swabs.

The detection of S. suis only after farrowing is probably associated with the increased population density or due to the presence of organisms shed by the artificially infected piglets immediately after inoculation. As S. suis was also detected in swabs of the environment of the litter infected with the low dose of organisms, the former hypothesis is more likely.

Streptococcus suis type 1 was found in the blood of 25% of these pigs. The bacteraemias were all detected in the first ten days of life. This age corresponds with the period when disease from this type is most prevalent (Anon, 1979a). Streptococcus suis type 2 was detected in the blood of 35% of these pigs. Unlike S. suis type 1, these bacteraemias were detected over a wide period (5 to 37 days), occurring both before and after weaning. These results are similar to those recorded in Chapter V where a bacteraemia of S. suis type 1 was only detected in sucking piglets, whilst bacteraemias of S. suis type 2 were found in suckers, weaners and porkers. Most bacteraemias were of short duration of only one to two days. Because of this short duration and the small volume of blood collected, it is possible that the true level of bacteraemias may be higher than that detected. All pigs that developed a bacteraemia were apparently normal and healthy. This absence of obvious clinical signs was similar to the findings of Clifton-Hadley and Alexander (1981) who found that the presence of S. suis type 2 in the blood, even in large numbers for prolonged periods, did not necessarily result in clinical disease. Clausen (1980) proposed that as well as infection with S. suis, other unknown secondary factors must also be present for disease to develop. There was no apparent pattern or correlation between the development of a bacteraemia and the time of initial infection with S. suis. Similar results were reported by Clifton-Hadley and Alexander (1981) who found that one pig subsequently developed a bacteraemia of S. suis type 2, eighteen days after intranasal infection. These pigs that have bacteraemias could be a possible human health risk as discussed further in Chapter VIII. The high proportion of bacteraemias of S. suis type 2 in young pigs may account for the high prevalence of

disease reported in humans in Hong Kong (Chau et al, 1983). As these people have a preference for eating suckling and weaner pigs, those involved in the slaughtering and handling of the carcasses of such young pigs would have a greater risk of contracting an infection with S. suis type 2.

CONCLUSIONS

1. Clinical disease could not be produced by merely the intranasal inoculation of field isolates of S. suis types 1 and 2 into piglets.
2. The infective dose of S. suis, when administered via the intranasal route, is less than 100 organisms.
3. S. suis types 1 and 2 are rapidly spread between pigs in a litter after artificial infection of some pigs in that litter.
4. A bacteraemia of S. suis can occur in a young pig without the presence of obvious clinical signs. These pigs could pose a public health risk if slaughtered.

INTRAVENOUS INFECTION OF PIGS WITH STREPTOCOCCUS SUIS

A. SENSITIVITY OF DETECTING S. SUIS IN BLOOD SAMPLES

INTRODUCTION

The experiment described here was performed to determine the number of organisms of S. suis type 2 that could be recovered from the blood of pigs after a known number had been injected intravenously. The sensitivity for detecting S. suis type 2 in the blood, could therefore be calculated by determining the ratio of the number of S. suis recovered from the blood to the initial number injected into the animal.

MATERIALS AND METHODS

Pigs

Five week old, weaned pigs from Herd 1 were housed in individual metabolism crates for two weeks prior to the experiments described here. In this period, pigs were fed a heat treated milk diet as part of a digestibility trial. On the day of experimentation, the sex and weight of each pig were recorded. The total volume of blood of each pig was calculated by using the approximation that pigs of their weight range had 80 ml of blood for every kg of live body weight (Bush et al, 1955; Swenson, 1970; 1975).

Infection Procedure

Pigs were anaesthetized with halothane⁶ administered by mask from a closed circuit anaesthetic machine⁷. After anaesthesia, pigs were inoculated with S. suis type 2 by an intravenous injection into their cephalic vein. In one pig this injection route was not achieved so the bacteria were inoculated into the anterior vena cava. An isolate of S. suis type 2 recovered from the palatine tonsil of an apparently normal bacon weight pig was used in this experiment. A culture of this organism was grown overnight in Todd Hewitt Broth and either injected directly into the pig or diluted prior to injection in physiological saline. Each pig was inoculated with one ml. The number of organisms in the inoculum was determined by a series of dilutions as described in Chapter IV. Three pigs were infected with 9.6×10^6 , two with 1.8×10^6 , three with 8.8×10^4 , four with 4.8×10^3 and three with 4.4×10^2 organisms of S. suis type 2.

Two to three minutes after infection, five ml of blood was collected from either the anterior vena cava or from the heart by direct cardiac puncture. The animal was then euthanased with an intravenous injection of sodium pentobarbitone⁸.

⁶ Fluothane, ICI Ltd, Macclesfield, Cheshire

⁷ Fluotec 3, Cyprane Keighley, England

⁸ Pentobarb 300, South Island Chemicals Ltd,
Christchurch New Zealand

Samples

Immediately following the collection of blood, duplicate one ml volumes of blood were evenly distributed over sheep blood agar plates. These plates were incubated for 18 hours at 37°C and the number of colonies of S. suis type 2 counted. Duplicate volumes of 0.5 ml of blood were also inoculated into a 4.5 ml solution of sterile physiological saline. These samples were similarly diluted a further two times. One ml of each dilution was plated onto sheep blood agar and handled as above. The number of S. suis type 2 originally present in the blood was calculated by adjusting the number of colonies for the dilution factor.

Samples of liver were also collected from each pig following euthanasia. These samples were flamed, incised and a swab taken of the cut surface and plated onto sheep blood agar. After incubation the colonies of S. suis type 2 were also counted.

Survival of S. suis type 2 in fresh blood

To study the survival and ability to isolate S. suis type 2 from the blood, an in vitro investigation was performed. Blood from weaners was collected aseptically into tubes containing the anticoagulant sodium EDTA. These samples were returned to the laboratory within 15 minutes of collection. A known number of S. suis type 2 were added to duplicated volumes of three ml of blood. Two minutes after the addition of the organisms, samples of blood were taken from this mixture. The number of S. suis type 2 present in the blood was determined by the methods described earlier. This number was compared with the initial number of organisms inoculated into the blood.

RESULTS

In Table 7.5 the number of S. suis type 2 inoculated into each pig and the subsequent number isolated from the blood and liver is recorded. Three minutes after inoculation, 6.6% (range of 0.0% to 7.8%) of the organisms initially injected into the pigs were recovered. No organisms were detected in the blood of pigs infected with less than 4.8×10^3 organisms (5 organisms per ml).

TABLE 7.5

THE RECOVERY OF S. SUIIS TYPE 2 FROM THE BLOOD AND LIVER
AFTER INTRAVENOUS INOCULATION

| NUMBER OF ORGANISMS INJECTED | WEIGHT OF PIG | NUMBER OF ORGANISMS/ML BLOOD | ORGANISMS ISOLATED/ML BLOOD (%) | NUMBER OF COLONIES RECOVERED FROM THE LIVER |
|------------------------------|---------------|------------------------------|---------------------------------|---|
| 9.6×10^6 | 12.5 | 9.6×10^3 | 7.5×10^2 (7.8) | 14 |
| 9.6×10^6 | 10.7 | 11.2×10^3 | 8.0×10^2 (7.1) | 20 |
| 9.6×10^6 | 12.2 | 9.8×10^3 | 5.3×10^2 (5.4) | 6 |
| 1.8×10^6 | 11.3 | 2.0×10^3 | 1.1×10^2 (5.5) | 0 |
| 1.8×10^6 | 10.2 | 2.2×10^3 | 1.1×10^2 (5.0) | 8 |
| 8.8×10^4 | 11.9 | 92 | 5 (5.4) | 0 |
| 8.8×10^4 | 11.9 | 92 | 6 (6.5) | 0 |
| 8.8×10^4 | 11.5 | 96 | 4 (4.2) | 0 |
| 4.8×10^3 | 12.3 | 5 | 0 (0) | 0 |
| 4.8×10^3 | 14.0 | 4 | 0 (0) | 0 |
| 4.8×10^3 | 13.0 | 5 | 0 (0) | 0 |
| 4.8×10^3 | 13.0 | 5 | 0 (0) | 0 |
| 4.4×10^2 | 13.1 | 0.4 | 0 (0) | 0 |
| 4.4×10^2 | 11.6 | 0.5 | 0 (0) | 0 |
| 4.4×10^2 | 11.3 | 0.5 | 0 (0) | 0 |

Only 2.2% of the number of S. suis type 2 actually isolated from each ml of blood could be isolated from liver swabs.

Two minutes after S. suis type 2 had been added to freshly collected blood containing anticoagulant, only 24% of the organisms could be recovered.

DISCUSSION

When a known number of S. suis type 2 were injected into the circulatory system of weaner pigs, only 6.6% of these organisms could be detected in blood collected within two to three minutes of the injection. When less than 10,000 organisms were injected, no organisms could be detected either from the blood samples or liver sections. As the test detected only 6.6% of the injected organisms, at least 15 organisms must be inoculated per ml of blood to detect one organism in a one ml sample of blood. Bull (1914, 1916) reported a ten fold reduction in the number of streptococci and pneumococci in the blood of rabbits and dogs one minute after intravenous infection. Wilson and Miles (1955) and Wright (1927) similarly demonstrated a large reduction in the numbers of circulating bacteria, with only 0.002% of avirulent bacteria, 2% of slightly virulent bacteria and 12.8% of highly virulent bacteria being isolated two hours after inoculation. They believed the reduction in bacteria was associated with phagocytosis by polymorphonuclear cells. In the present situation, with the short period between inoculation and sampling, it would seem unlikely that the drop in numbers is associated with phagocytosis. As the number of organisms isolated after in vitro inoculation with S. suis type 2 was 24% of the initial dose, it would appear that the further reductions in the numbers found in vivo may be associated with the adherence of streptococci to the walls of capillaries. Most of the initial reduction in numbers would appear to be from inactivation of viable streptococci by serum components. Bull (1915a; 1915b; 1915c) believed that the rapid removal of bacteria from the blood of rabbits was due to serum components leading to agglutination of bacteria and subsequent phagocytosis. As this experiment only detected viable S. suis type 2, organisms that were inactivated yet still circulating in the blood system, would not have been detected.

Only a small percentage (2.2%) of blood borne organisms were detected in swabs taken from the liver. As the number of S. suis type 2 present in the blood was determined by the number present in a one ml volume of blood, the difference in these results may only indicate the amount of blood absorbed by the swab and not a true absence of S. suis type 2 from this organ. If the volume absorbed by a swab was as low as 0.02 ml, only 2% of the organisms present in one ml of blood would have been detected.

In Chapter V it was shown that 2.7% and 3% of pigs slaughtered at a meatworks had S. suis type 2 present in the liver and blood respectively. From the present results, it would appear that samples of liver are a poor indicator of the presence of a bacteraemia. In Chapter V the livers of some pigs were identified as positive for S. suis type 2 and yet the pigs had negative blood cultures. This may indicate an infective process involving the liver or more likely is associated with a test of low sensitivity. The present findings would support the belief that the proportion of bacteraemias in slaughtered pigs is higher than that detected.

CONCLUSIONS

1. There was a rapid reduction in the number of viable circulating S. suis type 2 after artificial intravenous infection. This was probably associated with inactivation by serum components and adherence to capillary walls.
2. Swabs of liver tissue are a poor indicator of the presence of a bacteraemia in pigs.

B. INTRAVENOUS INFECTION WITH S. SUIS TYPE 2

INTRODUCTION

As outlined in the introduction to this chapter, attempts to produce disease in pigs by artificial infection with S. suis type 2 have had variable results. However it appeared that apart from direct

inoculation into the cerebro-spinal fluid, the intravenous route most frequently induced a pathological response. The present experiment was designed to study the pathogenicity and infectivity of S. suis type 2 for pigs when administered by the intravenous route. In this experiment the jugular veins were catheterized. This allowed routine sampling of the blood and provided an easy and accurate method for administering intravenous inoculations. This allowed both the numbers of S. suis present in the blood and the duration of bacteraemia to be studied.

MATERIALS AND METHODS

Animals

Piglets that had been weaned for one week (five to six weeks old) and were of a similar size were used in this experiment. The pigs originated from two litters of herd 1. The pigs were fasted for 18 hours prior to surgery but were allowed access to water.

Catheters

Catheters, approximately 30 cm long, were made from medical grade silicone rubber tubing⁹. The end that was to be inserted into the vein was bevelled to an angle of 60 degrees. Two collars were made with silicone medical adhesive⁹ on the tubing. These were placed three cm apart and two cm from the end of the catheter (Plate 7.1). Catheters were sterilized in Zephiran¹⁰ for 24 hours and were flushed with heparinized saline (Appendix VI) before use.

⁹ Dow Corning Corporation, Medical Products, Midland
Michigan U.S.A.

¹⁰ Winthrop Laboratories, Sterling Pharmaceuticals
(N.Z.) Ltd., Auckland

Anaesthesia

Pigs were sedated with a 0.5 ml intramuscular injection of azaperone¹¹. Surgical anaesthesia was induced using 5% halothane administered by a face mask. Anaesthesia was maintained with 1 to 2% halothane on a closed circuit anaesthetic machine¹².

Surgical Technique of Jugular Catheterization

The ventral neck region and the area between the shoulder blades were clipped and disinfected with a hibitane/methylated spirits solution (Appendix VI). The pig was placed in dorsal recumbency and maintained in this position by leg ties, with the fore limbs tied beside the rib cage.

A three to four cm incision was made through the skin, over the jugular groove. The jugular vein was reached by blunt dissection through the fat and fascia. A three cm section of the vein was released by further blunt dissection and the vein exteriorized. A bulldog clamp was placed on the cranial end of the vein, and a loose absorbable suture¹³ placed around its caudal end. A small incision was made in the jugular vein and the catheter inserted towards the heart so that the second collar was just within the lumen of the vein. The stay suture was then tightened and secured around the vein, caudal to the second collar. Another suture was placed cranial to this collar to encompass both the jugular and the catheter. A further suture was used to both ligate the jugular cranial to the catheter and to help stabilize the cannula. Suction was applied from a syringe and heparinized saline (Appendix VI) was flushed through the cannula to ensure the patency of the catheter. The cannula was temporarily clamped with a haemostat whilst the other jugular vein was exteriorized and catheterized. After both veins were catheterized, a blunt hollow probe with a removable tip was inserted at the site of incision. This probe was directed subcutaneously, laterally and dorsally to emerge between the shoulder blades. An incision was then

¹¹ Stresnil Smithkline and French Laboratories
(Australia) Limited, French's Forest, N.S.W.

¹² Fluotec 3, Cyprane Keighley, England

¹³ Dexon, Davis and Geck Inc, Manati, U.S.A.

made onto the end of the probe, the tip removed and a catheter passed through (Plate 7.2). The probe was then removed, with care being taken to avoid kinking of the cannula and the procedure repeated for the other side. The patency of the cannulae were again assessed by flushing and suction (Plate 7.3). Catheters were cut so that approximately two cm were protruding from the skin of the pig. A sterile 15 gauge luer-lock needle, that had previously had its point ground flat, was inserted into the cannula to provide a tight secure fit. An injection cap¹⁴ was placed on the needle to help maintain asepsis and to allow for easy access to the cannula and consequently blood. Horizontal mattress sutures¹⁵ were used to fix the cannulae in place on the back of the pig and to close the jugular furrow incision. A stretch stocking net¹⁶ was used to stabilize and protect the cannulae. This netting was placed over the pigs forequarter, with holes cut for the legs as shown in Plate 7.4. Pigs were given a single intramuscular injection of 2 ml of a streptomycin-penicillin¹⁷ mixture.

Housing

After the pigs had recovered from general anaesthesia, they were transported to a temperature controlled room maintained at 22°C. Pigs were housed in individual wire cages with their own feed troughs and nipple drinkers. There was a vacant cage between pigs so that there was no direct contact with other pigs. This was to prevent pigs from interfering with the catheters of neighbouring pigs.

Experimental Infection

Following the operation, pigs were initially inspected twice daily and then at daily intervals. Samples of blood (5 ml) were taken at each inspection and the cannulae flushed with sterile heparinized physiological saline (Appendix VI). Six days after surgery, the pigs

¹⁴ Jelco Intermittent Injection Cap, Critikon, Tampa, Florida

¹⁵ Vicryl 3.0 metric. Ethicon, Somerville, New Jersey

¹⁶ Surgifix size 7, F.R.A. Production, Italy

¹⁷ Streptopen, Glaxo New Zealand Limited, Palmerston North, N.Z.

PLATE 7.1

CANNULAE USED FOR JUGULAR CATHETERIZATION

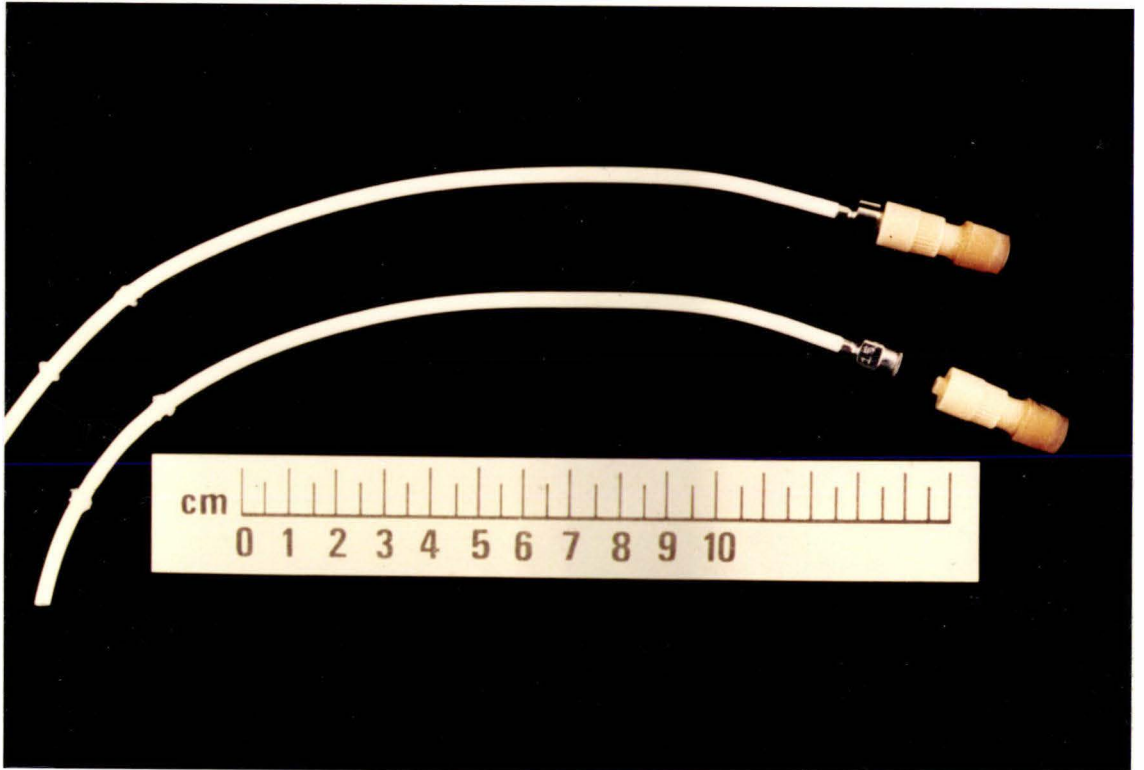

PLATE 7.2

DIRECTING THE CANNULA FROM THE JUGULAR FURROW TO THE DORSAL MIDLINE

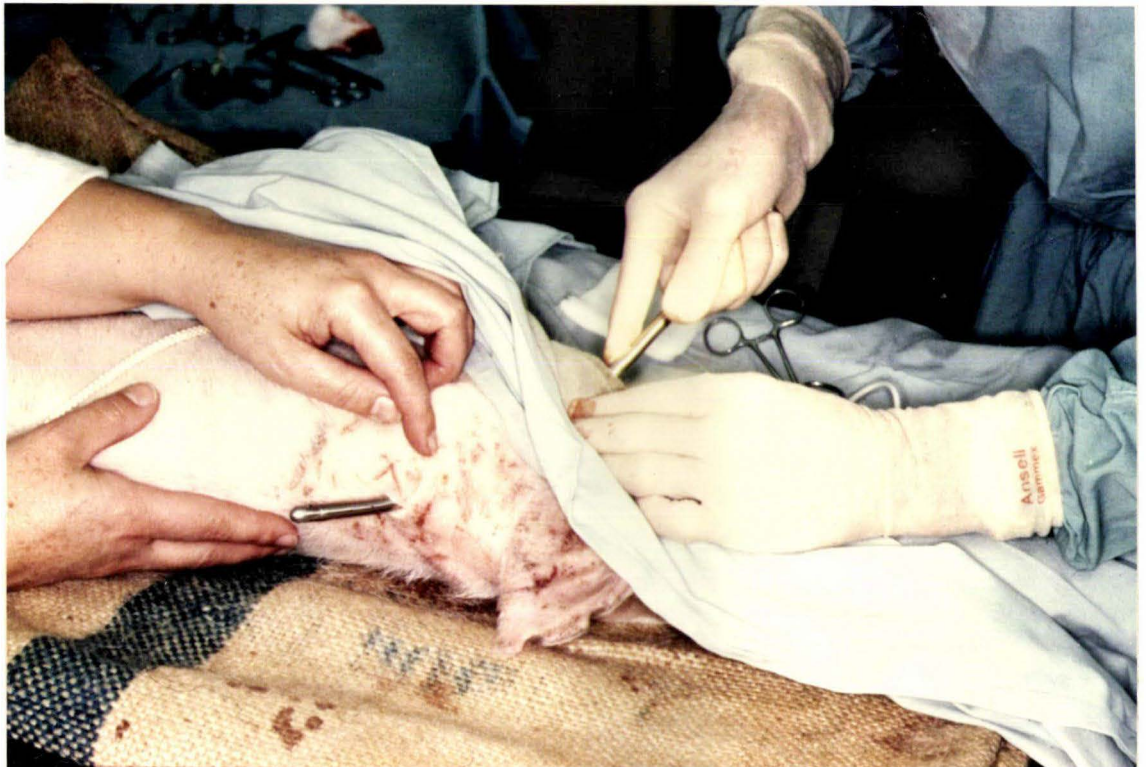

PLATE 7.3

FLUSHING OF THE CANNULA WITH HEPARINIZED SALINE

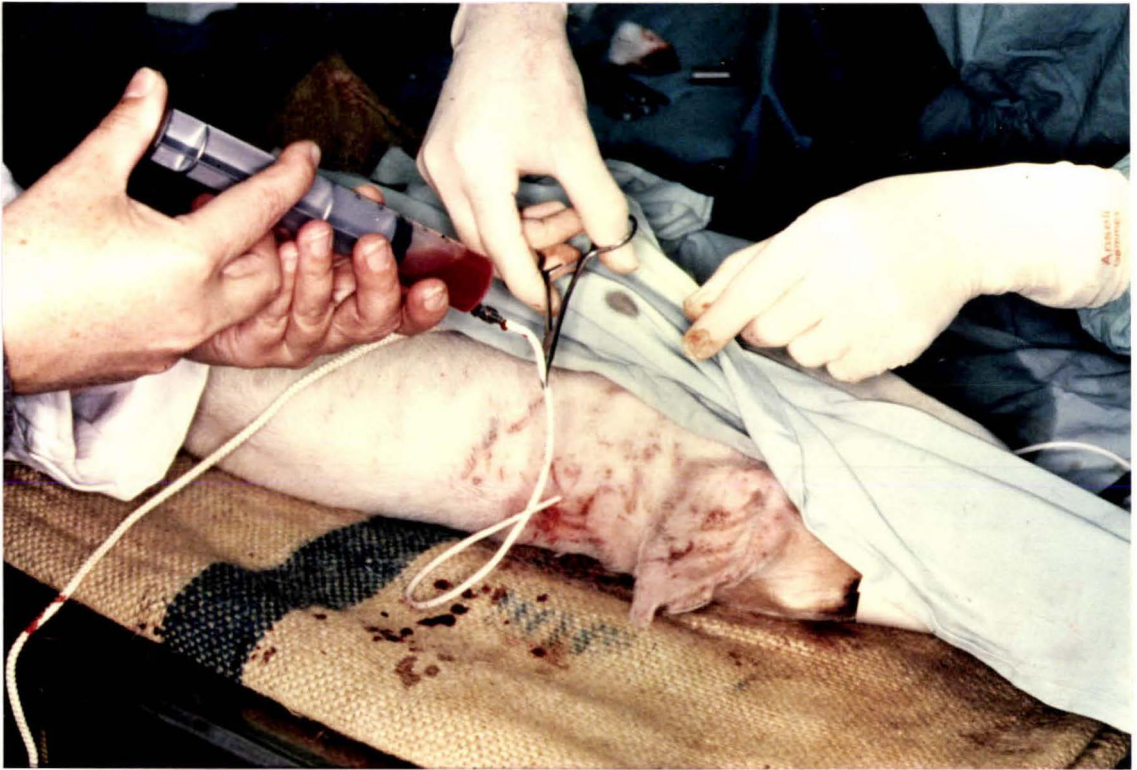

PLATE 7.4

THE PIG FOLLOWING JUGULAR CATHETERIZATION WITH A STRETCH STOCKING TO PROTECT THE CANNULAE



were inoculated with S. suis type 2. A field isolate of S. suis type 2 was grown overnight in Todd Hewitt Broth. This culture was diluted in physiological saline to obtain the approximate number of organisms required. The exact number of organisms injected was determined by a series of dilutions as described in Chapter IV.

In a preliminary trial to determine if the cannulation method would be successful, two pigs were inoculated with 200 organisms of S. suis type 2, seven days after surgery. These pigs were inoculated with a second dose of 2×10^4 organisms one week after the initial dose. A further three pigs (two females and one male) were inoculated with 3.5×10^7 organisms and another three (two males and one female) with 4.5×10^3 . In these pigs only one dose was administered, seven days after cannulation. All organisms were administered in a one ml volume into the catheters which were then flushed with two ml of sterile heparinized saline.

Blood samples were collected immediately prior to infection; one minute, ten minutes and one hour after infection; and then at daily intervals. In the first day after infection, blood was collected from the cannula that had not been used for the inoculation. This was done to reduce the possibility of detecting S. suis type 2 that may have remained within the cannula. After the collection of blood, the cannulae were flushed with two ml of heparinized saline to ensure that patency was maintained. Rectal temperatures were taken at approximately the same time each day.

Blood Samples

At each sampling, the first ml of blood was discarded to reduce the possibility of having blood diluted by the heparinized saline retained in the cannula. Two, one ml aliquots of blood were collected and evenly dispersed onto sheep blood agar plates. These plates were incubated for 18 hours at 37°C and the average number of colonies of S. suis type 2 determined. Approximately five ml of blood was also collected for the removal of serum. This blood was placed in sterile plastic bottles, left overnight at room temperature and the serum collected and stored at -20°C. An ELISA, to detect antibodies to both S. suis types 1 and 2, was performed as described in Chapter III.

An extra five ml of blood was collected and dispensed into a venoject¹⁸ tube containing 15 mg of sodium EDTA granules. This sample was gently rocked to ensure thorough mixing of the blood and anti-coagulant. The total number of white blood cells were counted using an automatic white cell counter¹⁹ and a differential white cell count was carried out on blood smears stained with a Wright Stain (Modified)²⁰.

Pathological Investigation

After the completion of the experiment, all pigs were euthanased with intravenous sodium pentobarbitone and autopsied. Organs were cultured for S. suis type 2 and segments of tissue fixed in 10% formalin for subsequent histopathological examination.

RESULTS

In Table 7.6, the number of S. suis type 2 isolated from each ml of blood at different intervals after intravenous inoculation is listed. Only 10.3% of the injected organisms were detected one minute after infection, 1.5% after ten minutes and 0.7% after one hour. Of the three pigs which received the high dose (10^7 organisms), two (6 and 5) remained bacteraemic for six and seven days respectively, whilst the other pig was still bacteraemic one day after infection when both cannulae became occluded. Streptococcus suis type 2 was detected in the blood for up to one hour in pigs receiving 10^4 organisms. However, S. suis type 2 could not be isolated from the blood at any time in two pigs infected with only an estimated 200 organisms. One of the pigs (7) that was infected with 10^4 organisms, subsequently developed a bacteraemia, seven days after the initial infection. This bacteraemia was detected for two days before the pig was euthanased. This pig was the only one to develop the "classical" clinical signs of infection by S. suis type 2. On the day before the bacteraemia developed, the pig showed front leg lameness, anorexia and

¹⁸ Terumo Corporation, Tokyo, Japan

¹⁹ Cell-Dyn 900, Sequoia-Turner Corporation, Mountain View California

²⁰ Accustain, Sigma Diagnostics, St Louis, USA

TABLE 7.6

NUMBERS OF S. SUIIS TYPE 2 ISOLATED FROM THE BLOOD AFTER
INTRAVENOUS INFECTION

| ANIMAL NUMBER | 1# | 2# | 3 | 4 | 5 | 6 | 7 | 8 |
|--|---|------------------------|--------|--------|-------------------|------------------|-----------------------|-----------------|
| NUMBER OF <u>S. SUIIS</u> INJECTED | 200 2×10^4 | 200 2×10^4 | 10^4 | 10^4 | 10^7 | 10^7 | 10^4 | 10^7 |
| NUMBER OF <u>S. SUIIS</u> INJECTED/ML BLOOD | 0.4 42 | 0.4 42 | 21 | 21 | 2×10^4 | 2×10^4 | 21 | 2×10^4 |
| DAYS AFTER OPERATION | NUMBER OF <u>S. SUIIS</u> TYPE 2 ISOLATED FROM EACH ML OF BLOOD | | | | | | | |
| 1 to 6 | 0 | 0 | 0 | 0 | 0 | 0 | 0 | 0 |
| 7 days & 1 min | 0 | 0 | 5 | 3 | 3×10^3 | 2×10^3 | 3 | 10^3 |
| 7 days & 10 min | 0 | 0 | 1 | 0 | 1.6×10^2 | 90 | 1 | 80 |
| 7 days & 60 min | 0 | 0 | 0 | 1 | 55 | 40 | 0 | 40 |
| 8 | 0 | 0 | 0 | 0 | 1.6×10^2 | 2×10^3 | 0 | 2×10^2 |
| 9 | 0 | 0 | 0 | 0 | 8×10^4 | 16×10^4 | 0 | - |
| 10 | 0 | 0 | 0 | 0 | 6.6×10^2 | 4×10^2 | | - |
| 11 | 0 | 0 | 0 | 0 | 4×10^2 | 50 | 0 | - |
| 12 | 0 | 0 | 0 | 0 | 2.4×10^2 | 80 | 0 | - |
| 13 | 0 | 0 | 0 | 0 | 1×10^2 | 30 | 0 | - |
| 14 days & 1 min | 7 | 2 | 0 | 0 | 20 | 0 | 2 | - |
| 14 days & 10 min | 4 | 2 | | | | | | |
| 14 days & 60 min | 1 | 0 | | | | | | |
| 15 | 0 | 0 | 0 | 0 | 0 | 0 | 2.4×10^3 ##* | - |
| 16 | 0 | 0** | 0 | 0 | - | 0 | | - |
| 17 | 0 | | 0 | 0 | -## | 0 | | - |
| 18 | 0 | | 0 | 0 | | 0 | | - |
| 19 | 0 | | 0 | 0 | | 0 | | - |
| 20 | 0 | | 0 | 0 | | 0 | | - |
| 21 | 0## | | 0 | 0## | | 0## | | - |
| 22 | | | 0 | | | | | - |
| 23 | | | 0 | | | | | - |
| 24 | | | 0 | | | | | - |
| 25 | | | 0 | | | | | - |
| 26 | | | 0## | | | | | -## |

pigs infected with two doses of S. suis type 2_

euthanasia

* clinical meningitis

- blocked canula no blood sample collected

** death

depression. These signs persisted for two days and were accompanied by incoordination, staggering and lateral recumbency with paddling and opisthotonus. The following day the pig was brighter, in sternal recumbency and was eating and drinking before being subsequently euthanased. After the second inoculation, pigs 1 and 2 which both received two doses of S. suis type 2, showed signs of rapid respiration, dyspnoea, anorexia and a fever of up to 42°C. Pig number 2 subsequently died whilst pig number 1 was euthanased seven days after the second injection. In these pigs S. suis type 2 was not detected in the blood one hour after the second inoculation. The gross pathological changes detected at autopsy for all pigs are listed in Table 7.7 and the subsequent microbiological findings in Table 7.8. The severe pneumonia found in two pigs (1 and 2) appeared to be caused by a secondary infection of C. pyogenes associated with an infection by the organism around the tract of the catheter. The only other pig to show any evidence of clinical abnormality was pig number 4 which developed forelimb lameness. Streptococcus suis type 2 was subsequently cultured from the right shoulder joint and a meningeal swab of this pig, although it did not show any nervous signs. The brain of this pig also showed histopathological changes of congested meninges and spongiosis of the white and grey matter (Table 7.9). On autopsy, the pigs that received two doses of S. suis type 2 and subsequently developed respiratory signs, had a purulent bronchopneumonia with an acute necrotizing bronchitis. One of these pigs had a jugular phlebitis and the presence of necrotic tissue in sections of the cannula site. The pig that developed nervous signs had a meningitis and encephalitis characterized by vacuolation of white matter of the brain, mild gliosis and infiltration of the cerebellum with neutrophils. Three pigs (3, 5, 8) did not show obvious clinical signs, had no significant histopathological changes and S. suis type 2 was not isolated from any of the organs sampled.

The body temperature of the pigs fluctuated between 38.9°C and 41.1°C. When pig 7 developed clinical signs of meningitis, its body temperature was raised by only 0.4°C to 40.3°C. There appeared no obvious correlation between the body temperature and the presence of clinical disease in these pigs.

In Figure 7.3 the total white cell count for pigs 3 to 8 is shown with respect to the time after intravenous infection. There was no

TABLE 7.7

MACROSCOPIC LESIONS DETECTED IN PIGS INFECTED WITH
S. SUIIS TYPE 2 VIA THE INTRAVENOUS ROUTE

| PIG NUMBER | GROSS PATHOLOGICAL FINDINGS |
|------------|--|
| 1 | Enzootic pneumonia with necrotizing pneumonia, lung abscesses and pleuritis. Slight meningeal congestion. Sinuses along catheter pathways. |
| 2 | Severe necrotizing pneumonia. Congested brain. Fibrin strands on parenchymatous organs. Sinuses along catheter pathways. |
| 3 | None |
| 4 | Fibrin tags on peritoneum. Fibrinopurulent arthritis of right elbow. |
| 5 | None |
| 6 | Small amounts of fibrin on peritoneum |
| 7 | Congested meninges. Changes typical of enzootic pneumonia. Excess peritoneal fluid. Fibrinopurulent tags of right elbow (radio-humeral joint). |
| 8 | None |

TABLE 7.8

MICROBIOLOGICAL FINDINGS FROM PIGS INFECTED WITH
S. SUIS TYPE 2 VIA THE INTRAVENOUS ROUTE

| PIG NUMBER | BRAIN | MENINGES | LIVER | KIDNEY | SPLEEN | LUNG | JOINTS | JUGULAR CANULA SITE |
|------------|-------|--|---|--------|--------------------|---|---|---------------------|
| 1 | - | <u>S. suis</u> type 2 <u>C. pyogenes</u> | <u>C. pyogenes</u> <u>P. multocida</u> | - | <u>C. pyogenes</u> | <u>C. pyogenes</u> <u>P. multocida</u> | - | <u>C. pyogenes</u> |
| 2 | - | - | - | - | - | <u>C. pyogenes</u> | - | - |
| 3 | - | - | - | - | - | - | - | - |
| 4 | - | <u>S. suis</u> type 2 | - | - | - | - | <u>S. suis</u> type 2 | - |
| 5 | - | - | - | - | - | - | - | - |
| 6 | - | - | - | - | - | - | - | - |
| 7 | - | <u>S. suis</u> type 2 | <u>S. suis</u> type 2 | - | - | Coliforms group B streptococcus | <u>S. suis</u> type 2 from carpus | - |
| 8 | - | - | - | - | - | - | - | - |

- no organism isolated

TABLE 7.9

HISTOPATHOLOGICAL FINDINGS IN PIGS INFECTED WITH
S. SUIIS TYPE 2 BY THE INTRAVENOUS ROUTE

| PIG NUMBER | HISTOPATHOLOGICAL FINDINGS |
|---------------|--|
| 1 | <p>Lung - severe purulent bronchopneumonia bronchi and bronchioles filled with large numbers of neutrophils and mild hyperplasia of epithelium</p> <p>mediastinal lymph nodes - neutrophil infiltration and microabscess formation</p> <p>liver - mild diffuse vacuolation of hepatocytes</p> |
| 2 | <p>Lung - acute necrotizing bronchitis with congestion and oedema. Large numbers of neutrophils and mononuclear cells in airways.</p> <p>Liver - congested with neutrophils, plasma cells and macrophages infiltrating the hepatic sinuses.</p> <p>Kidney - moderate intertubular congestion and focal haemorrhage</p> <p>Jugular vein - loss of endothelium and replacement with necrotic tissue</p> <p>Brain - severe and widespread congestion in parenchyma and meninges</p> |
| 3 | No abnormalities detected |
| 4 | <p>Brain - diffuse congestion of meninges with occassional focal haemorrhage. Mild spongiosis in both grey and white matter in cerebrum.</p> <p>Spleen - proliferation of reticular cells</p> <p>Liver - diffuse migration of leucocytes into the sinuses</p> |

(continued)

TABLE 7.9 (CONTINUED)

| PIG NUMBER | HISTOPATHOLOGICAL FINDINGS |
|---------------|--|
| 5 | No abnormalities detected |
| 6 | Liver - mild hydropic change of hepatocytes with local infiltration of mononuclear cells into parenchyma and around the portal triads. Spleen - mild lymphoid hyperplasia |
| 7 | Meninges - moderate congestion with moderate diffuse infiltration by macrophages, mononuclear cells and occasional neutrophils throughout the subarachnoid space. Brain - mild widespread vacuolation in the white matter of the brain with occasional spheroid formation and perivascular mononuclear cuffing. Vacuolation of subcortical white matter. Mild gliosis with diffuse infiltration by neutrophils in the cerebellum. Lung - collapse of alveoli together with hypertrophy of alveolar epithelium and interstitial thickening with mononuclear cells and fibroblasts. Liver and Spleen - as for number 6 Jugular Vein - fibrinopurulent inflammation of the tunica interna |
| 8 | No abnormalities detected |

FIGURE 7.3

TOTAL WHITE CELL COUNTS OF PIGS INTRAVENOUSLY INFECTED
WITH S. SUIIS TYPE 2

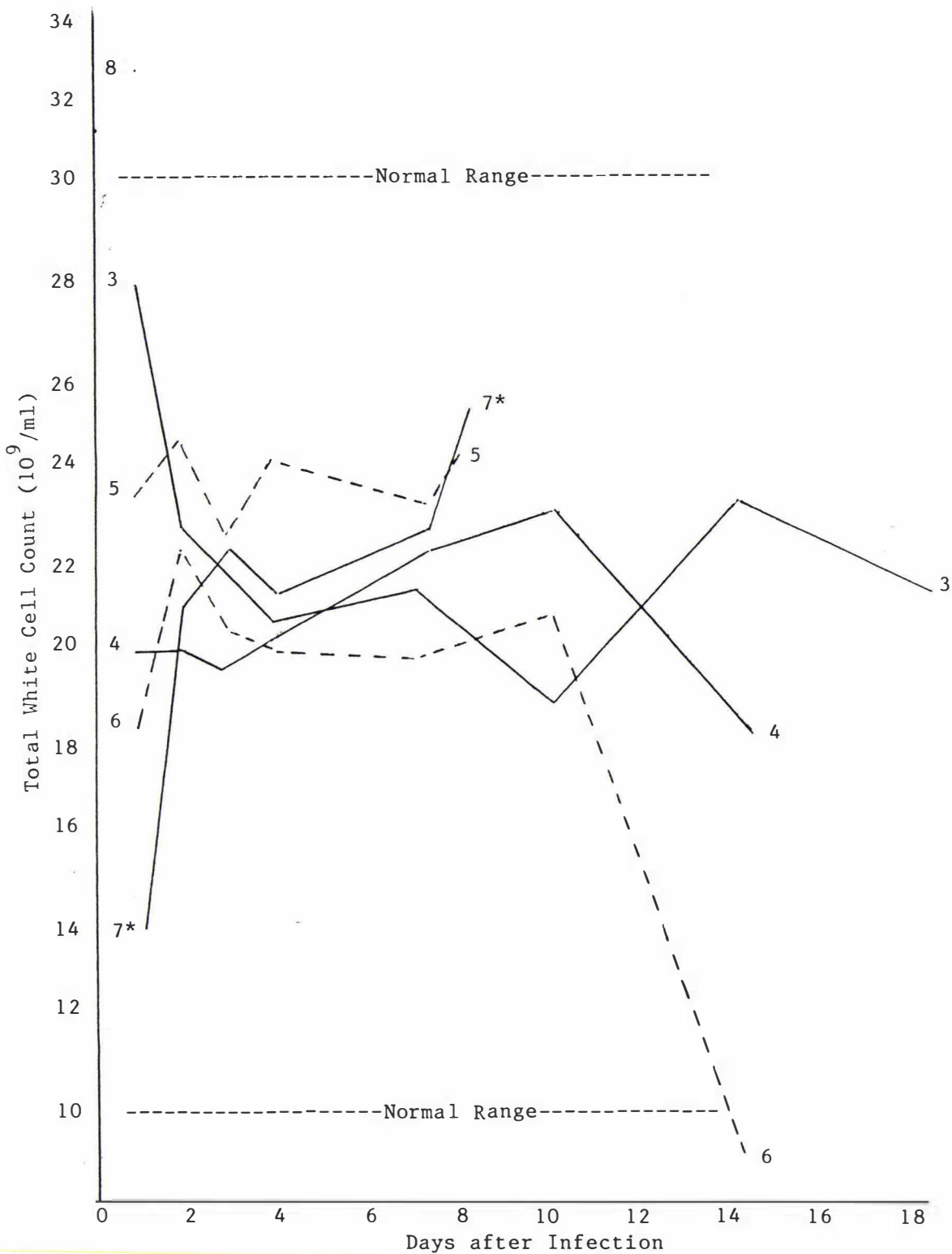

Numbers 5,6 & 8 - 10^7 Organisms - - - -

Numbers 3,4 & 7 - 10^3 Organisms ———

* - pig with clinical meningitis

Normal Range - 10 to $30 \times 10^9/\text{ml}$

obvious pattern in the total white cell count when compared with either body temperature or the presence of clinical signs. Only two samples were outside the "normal" range of 10 to 30×10^9 cells per ml of blood (Dunne, 1963; Coles, 1974).

Figures 7.4 and 7.5 demonstrate the titres of antibodies to S. suis types 1 and 2 respectively over the period of experimentation for pigs 3 to 8. There was a gradual rise in the antibody titre after infection. In the pig that developed signs of meningitis, there was a slight drop in the titre to S. suis type 2 after the onset of clinical disease. No decrease in titre to S. suis type 1 was seen in this pig.

DISCUSSION

Cannulation of the jugular vein offers the advantages of access to a plentiful supply of blood, an easy method of sampling and the minimizing of stress during collection of blood (Folley and Knaggs, 1966; Shearer and Neal, 1972; Pento, 1974). In the present experiment, the value of performing bilateral cannulations was evident with the failure of some catheters to remain patent. Although both cannulae in pigs 8 and 5 became blocked nine and sixteen days after the operation, at least one cannula remained patent in all other pigs for the duration of the experiment (up to 26 days). With two indwelling catheters, the chances of both becoming blocked are obviously less than if only one catheter had been used. However, pigs did require to be separated to prevent neighbouring pigs from chewing the catheter and interfering with its patency.

The results of this experiment support the findings of Friend and Sims (1978) and Clifton-Hadley and Alexander (1981) in demonstrating the difficulty in consistently reproducing disease after artificial infection with S. suis type 2. Only one of eight pigs, infected by the intravenous route, developed the "classical" clinical signs of meningitis and arthritis. However, another pig did develop arthritis in one joint apparently associated with infection by S. suis type 2. None of the twelve litter mates to the experimental pigs developed any obvious nervous signs or lameness during the course of these experiments. (The normal post weaning mortality for this herd is 1.57% with most of these losses being associated with enteric diseases).

FIGURE 7.4

ANTIBODY TITRE TO S. SUIIS TYPE 1 IN PIGS INTRAVENOUSLY INFECTED
WITH S. SUIIS TYPE 2

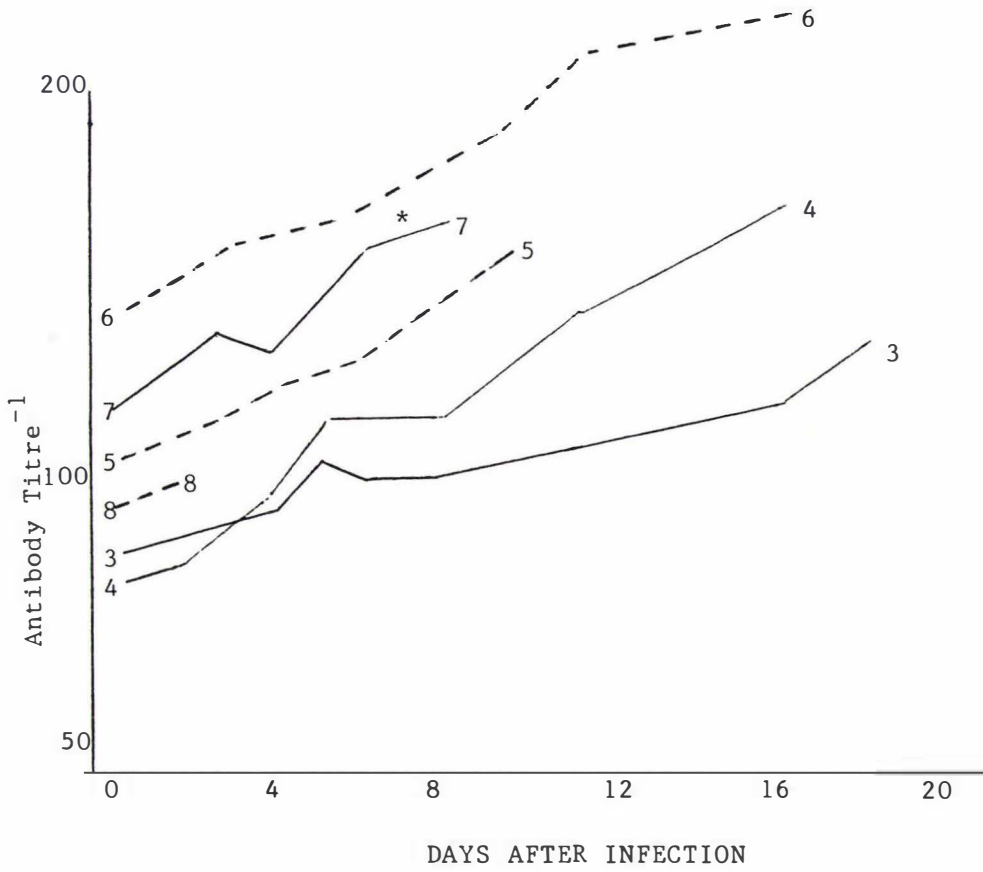

* - Clinical Meningitis

FIGURE 7.9

ANTIBODY TITRE TO S. SUIIS TYPE 2 IN PIGS INTRAVENOUSLY INFECTED

WITH S. SUIIS TYPE 2

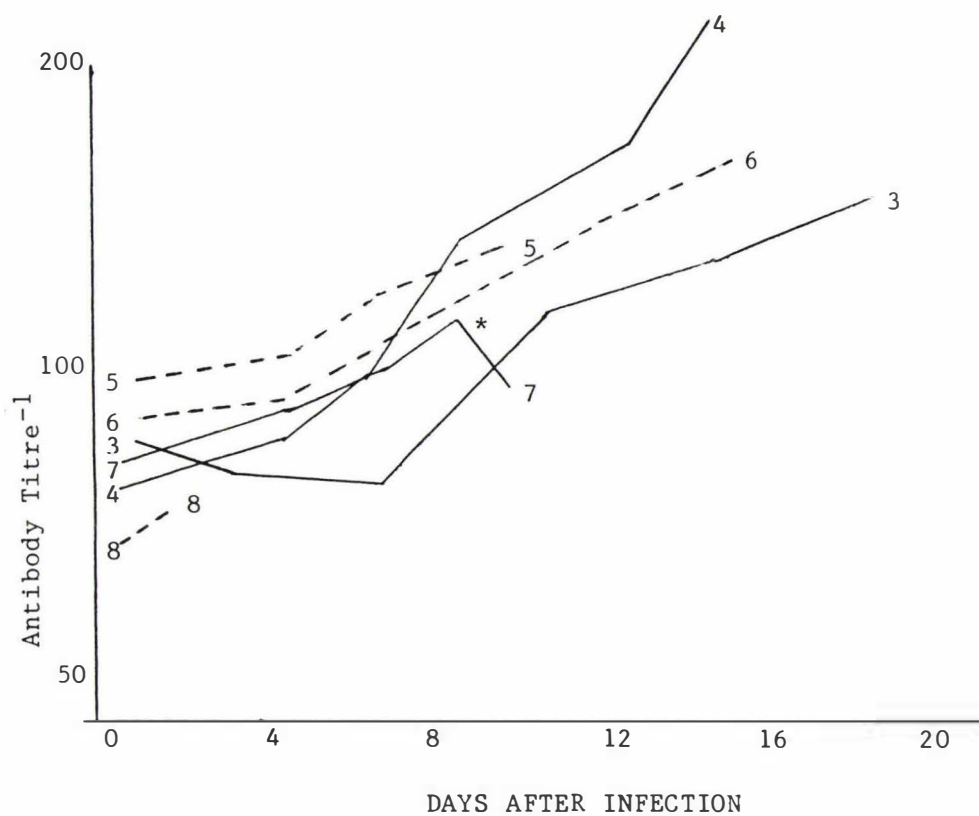

* - Clinical Meningitis

Although the pig that developed meningitis was showing signs of recovering when it was euthanased, it is highly probable that this pig would have died if it had been housed with other pigs because of their aggressive nature (Putten, 1981). In this pig, the artificially induced bacteraemia was detected for only ten minutes after infection. However seven days after the initial infection, a second bacteraemia developed coinciding with the occurrence of clinical signs. This second bacteraemia may have originated from organisms still present in the blood yet not detected because of a test with low sensitivity, or from an undetected focus of infection elsewhere in the body such as the palatine tonsil. These findings were similar to those of Clifton-Hadley and Alexander (1981) who found that one pig developed a fever and bacteraemia, eighteen days after intranasal infection. In the present experiment two pigs also developed a severe necrotizing pneumonia. However, this was probably caused by a secondary infection with C. pyogenes originating from infection around the catheters.

Streptococcus suis type 2 was isolated from the joints as well as the meninges of both pigs with signs of lameness. The isolation of S. suis type 2 from the meninges of pigs without neurological signs was also reported by Clifton-Hadley and Alexander (1981). The isolation of this organism from the meninges does not therefore necessarily imply the presence of clinical disease. This could mean that either secondary factors or more virulent strains of S. suis type 2 are necessary for the more consistent development of "classical" disease.

In the present experiment S. suis type 2 were detected in the blood of apparently normal pigs for up to eight days. Up to 10^5 organisms/ml of blood were detected in pigs without signs of clinical disease. However, the pig that did show clinical disease, only had a bacteraemia of just greater than 10^3 organisms/ml of blood. This would support the hypothesis of Clausen (1980) who believed secondary factors were necessary for the development of disease.

As S. suis type 2 was isolated from the blood of apparently normal pigs it is equally possible that it could be isolated from the blood of "diseased" pigs. Due to the rich blood supply of most organs in the body, the finding of this organism in tissues of diseased pigs should therefore be interpreted cautiously. Similarly, detection of

S. suis type 2 in the brain or meninges does not necessarily infer a disease process is occurring. Therefore, the association of S. suis type 2 with diseased tissue does not imply causation.

In this study the proportion of viable S. suis type 2 recovered from the blood one minute after inoculation (10%), was slightly greater than that recovered after two to three minutes (6.6%) as described in the previous section. In the first ten minutes after infection, the reduction in the number of organisms would possibly be associated with the action of factors in the serum as described by Bull (1915a, 1915c) and discussed earlier. However one hour after infection, phagocytosis could be helping reduce this number of bacteria (Bull, 1915a). Wright (1927) found that in his experiment, the initial rapid clearing of virulent pneumococci could be reduced when a culture in its logarithmic phase was inoculated. In this experiment, all streptococci inoculated were from an 18 hour culture and the organisms would therefore be reaching the end of their logarithmic phase.

The number of S. suis type 2 isolated from the blood would be determined by the rate of bacterial multiplication and the rate of removal from the blood stream. In pigs which repeatedly gave positive blood cultures, S. suis type 2 probably both multiplied and was removed at a similar rate as the number of organisms per ml of blood was relatively constant. There was no apparent dose response for the development of disease. In fact, the pig that did develop meningitis received the "lower" dose of 10^4 organisms. This finding also supports the belief that secondary factors must also be present, as well as infection with S. suis type 2, for the subsequent development of disease.

Wilson and Miles (1955) believed that the injection of a potentially virulent organism into an animals blood stream produced greater dissemination of the organism. This caused the organisms to be "diluted" in the healthy "antibacterial tissues" of the animal. This may allow for easier access to, and destruction of organisms by phagocytes than if they were localized in one particular site. They believed that localization could allow the multiplication of organisms to produce a focus of infective particles which could later disseminate throughout the body. This may have occurred in the pig

that subsequently developed a bacteraemia and meningitis, however no obvious focus of infection was found. Although the tonsil acts as a reservoir of infection, it appears there are not large numbers of organisms present in normal tonsillar tissue as Arends *et al* (1984) could find only a few colonies of S. suis type 2 in most tonsillar sections.

The total and differential white cell counts did not appear to have any correlation with either the development of clinical signs or the presence of S. suis type 2 in the blood. Only two total white cell counts were outside the normal range expected for pigs of this age (Dunne, 1963; Coles, 1974; Calhoun and Brown, 1975). This could again indicate that humoral rather than cellular components initially played an important role in the inactivation of viable S. suis type 2.

There was a gradual increase in the titres to S. suis type 2 during the experiment. Antibodies against both S. suis types 1 and 2 appeared to increase at similar rates. These findings are consistent with those reported in Chapter VI for naturally infected piglets. However, the pig that developed meningitis developed a slight drop in titre corresponding with the period of clinical signs and bacteraemia. This fall in titre may have been associated with the presence of excess antigen. No similar drop in titre to S. suis type 1 was recorded. This further supports the belief that the antibody measured by the ELISA was specific for S. suis.

CONCLUSIONS

1. An isolate of S. suis type 2 cultured from the palatine tonsils was capable of producing clinical signs after intravenous inoculation into pigs. There was no apparent dose response to the number of organisms injected.
2. Other unknown factors are required for the development of clinical disease besides the presence of S. suis type 2 in the blood even when in large numbers and for long periods.
3. Streptococcus suis type 2 can survive in the bloodstream of pigs without any apparent pathological effect and therefore the isolation

of this organism from "diseased" tissue does not necessarily imply causality.

INFECTION OF THE CEREBRO-SPINAL FLUID (CSF) WITH S. SUIIS TYPE 2

INTRODUCTION

The difficulty in consistently reproducing clinical disease after infection with S. suis type 2 has been demonstrated earlier in this chapter and also by Friend and Sims (1978). Clausen (1980) demonstrated that meningitis could only be produced when S. suis type 2 was injected directly into the subarachnoid space. The aim of the present experiment was to investigate if

1. disease could be reproduced consistently by the injection of S. suis type 2 into the C.S.F.
2. if different isolates of S. suis type 2 had differing degrees of pathogenicity.

MATERIALS AND METHODS

Animals

Piglets that had been weaned for three days (five weeks old) were used in this experiment. All sixteen pigs originated from herd 1 and were from four litters. After inoculation, pigs were housed in individual pens approximately one metre by two metres in size. Pens had solid walls and there was no direct contact between neighbouring pigs. Each pig was fed weaner pellets in an open concrete trough and water was provided from a nipple drinker.

Infection Procedure

Pigs were fasted for 18 hours prior to infection but were allowed access to water. The pigs were initially sedated with an intramuscular

injection of 0.5 ml of azaperone²¹ and surgical anaesthesia was induced with 5% halothane administered by a face mask. Anaesthesia was maintained with 1% to 2% halothane on a closed circuit anaesthetic machine.

The dorsal region of the neck, from the nuchal crest to the fifth cervical vertebrae, was clipped and disinfected with a solution of hibitane and methylated spirits (Appendix VI). Pigs were placed in right lateral recumbency and the head flexed so that the long axis of the head was at a right angle to the cervical vertebrae. This position helped maximize the dorsal space between the occipital condyles and the first vertebra. A 22 gauge, two and a half inch (6.3 cm) needle²² containing a steel stiletto was inserted in the midline at right angles to the skin approximately three cm caudal to the nuchal crest. To assist in the positioning of this needle and to show the anatomical structure, a radiograph had initially been taken of the skull and cervical vertebrae of an anaesthetized pig (Plate 7.5). When the needle was believed to be situated in the subarachnoid space, the inner stiletto was removed, and if the needle was correctly positioned C.S.F. would drip from the hub (Plate 7.6). In several pigs repositioning was necessary to ensure correct placement of the needle. S. suis type 2 was then gently administered in a volume of 0.5 ml. After inoculation the needle was withdrawn and the pig disconnected from the anaesthetic machine and allowed to recover.

Two pigs were inoculated with approximately 2.5×10^5 organisms of a non-capsulated strain of S. suis type 2. This isolate had been cultured from the palatine tonsils of apparently healthy pigs slaughtered at a meatworks. The isolate had been subcultured for approximately six months and it was during this period of subculturing that the capsule was lost.

Five pigs were inoculated with approximately 2.4×10^5 and another five with approximately 8×10^2 capsulated organisms of S. suis type 2. This isolate had been cultured from the palatine tonsils approximately three months prior to this experiment.

21 Stresnil, Smithkline and French Laboratories
(Australia) Limited, French's Forest, N.S.W.

22 Monoject, Sherwood Medical Industries Inc.,
Deland, Florida

PLATE 7.5

RADIOGRAPH OF THE PIG HEAD FOR POSITIONING OF THE NEEDLE
INTO THE SUBARACHNOID SPACE



PLATE 7.6

POSITIONING OF THE NEEDLE IN THE SUBARACHNOID SPACE



Two pigs were also inoculated with approximately 8×10^5 organisms of S. suis type 2 which had been isolated from a human patient with a bacteraemia (Dickie et al, 1987).

Two pigs were injected with 0.5 ml of Todd Hewitt Broth diluted in physiological saline to a concentration of 1/400. These pigs were used as controls and were handled in a similar manner to the infected pigs.

All isolates of S. suis type 2 were initially grown in Todd Hewitt Broth for 18 hours. This culture was diluted in physiological saline to obtain the required number of bacteria. The approximate number of bacteria present in each inoculum was determined by a series of dilutions as described in Chapter IV.

Clinical Signs, Microbiology and Pathology

During the experiment, pigs were examined at least twice daily for the development of clinical signs. All pigs were euthanased with intravenous sodium pentobarbitone within three weeks of infection and were autopsied and examined for gross pathological changes. Portions of brain, spinal cord, liver, spleen and kidney were fixed in 10% formalin and examined for histopathological changes. A swab of the meninges and tissue from the brain, liver, kidney and spleen were cultured on sheep blood agar.

RESULTS

Table 7.10 summarizes the clinical signs, microbiological results and pathological findings for the 16 pigs used in this experiment. Although several pigs showed signs of excitability two to three hours after the inoculation, only the two pigs that received the human strain developed an obvious persistent nervous disorder. These pigs showed the "classical" signs of opisthotonus, paddling and tetanic spasms (Plate 7.7). The initial excitability shown by some pigs may have been associated with the injection technique as one control pig also showed these signs. Two other pigs did show signs of slight hind leg incoordination and depression. Streptococcus suis type 2 was isolated from the brain or meninges of all pigs other than one pig

TABLE 7.10

CLINICAL, MICROBIOLOGICAL AND PATHOLOGICAL FINDINGS OF SUBARACHNOID INOCULATION WITH S. SUIS TYPE 2

| <u>ISOLATE OF S. SUIS TYPE 2</u> | DOSE | SEX | TIME OF EUTHANASIA AFTER INFECTION | CLINICAL SIGNS | RECOVERY OF <u>S. SUIS</u> | GROSS PATHOLOGICAL LESIONS | HISTOPATHOLOGICAL LESIONS |
|--|-----------------------|-----|---|--------------------------|-------------------------------|----------------------------------|--|
| Non-capsulated | 2.5 x 10 ⁵ | M | 8 | Slight incoordination | Brain Meninges | - | Mild subacute meningitis Vacuolation of white matter |
| Non-capsulated | 2.5 x 10 ⁵ | F | 8 | Normal | - | - | Focal axonopathy in cerebellar peduncle |
| Porcine Field Strain | 2.4 x 10 ⁵ | M | 5 | Normal | Brain Meninges | - | Occasional glial nodule with infiltration of mononuclear cells Subacute interstitial nephritis |
| Porcine Field Strain | 2.4 x 10 ⁵ | M | 3 | Slight incoordination | Meninges | - | Occasional glial nodule congestion of meninges |
| Porcine Field Strain | 2.4 x 10 ⁵ | F | 19 | Normal | Brain | - | Occasional mononuclear infiltration into portal sinusoids |
| Porcine Field Strain | 2.4 x 10 ⁵ | M | 19 | Normal | - | - | Occasional glial nodule with infiltration of mononuclear cells subacute interstitial nephritis |
| Porcine Field Strain | 2.4 x 10 ⁵ | F | 5 | Normal | Meninges | - | Occasional glial nodule with infiltration of mononuclear cells Subacute interstitial nephritis |

(CONTINUED)

TABLE 7.10 (continued)

| <u>ISOLATE OF S. SUIS TYPE 2</u> | DOSE | SEX | TIME OF EUTHANASIA AFTER INFECTION | CLINICAL SIGNS | RECOVERY OF <u>S. SUIS</u> | GROSS PATHOLOGICAL LESIONS | HISTOPATHOLOGICAL LESIONS |
|--|-----------------|-----|---|-------------------------|-----------------------------------|----------------------------------|---|
| Porcine Field Strain | 8×10^2 | M | 3 | Initial excitability | C.S.F., meninges spleen, blood | - | Mild infiltration of mononuclear cells into subarachnoid space |
| Porcine Field Strain | 8×10^2 | M | 10 | Normal | Brain | - | Mild infiltration of mononuclear cells into subarachnoid space Occasional glial nodule Subacute interstitial nephritis |
| Porcine Field Strain | 8×10^2 | M | 10 | Initial excitability | Brain Meninges | - | Occasional glial nodule with infiltration of mononuclear cells subacute interstitial nephritis |
| Porcine Field Strain | 8×10^2 | M | 5 | Normal | Brain, meninges kidney, blood | - | Occasional glial nodule with infiltration of mononuclear cells subacute interstitial nephritis |
| Porcine Field Strain | 8×10^2 | F | 19 | Initial excitability | - | - | subacute interstitial nephritis |

(CONTINUED)

TABLE 7.10 (continued)

| ISOLATE OF S. SUIS TYPE 2 | DOSE | SEX | TIME OF EUTHANASIA AFTER INFECTION | CLINICAL SIGNS | RECOVERY OF S. SUIS | GROSS PATHOLOGICAL LESIONS | HISTOPATHOLOGICAL LESIONS |
|---------------------------------|-----------------|-----|---|--|---------------------------|----------------------------------|--|
| Control 1/400 broth | 0 | M | 19 | Initial excitability | - | - | subacute interstitial nephritis |
| Control 1/400 broth | 0 | F | 5 | Normal | - | - | Occasional glial nodules subacute interstitial nephritis |
| Human Isolate | 8×10^5 | M | 1 | Initially normal 8 hrs depression 12 hrs lateral recumbency 24 hrs opisthotonus padding, tetanic spasms | Brain, C.S.F. meninges | Opaque congested meninges | Lepto/pachymeningeal infiltration by neutrophils and mononuclear cells. Laminar necrosis of superficial cerebral cortex. Inflammation of cerebellum. |
| Human Isolate | 8×10^5 | F | 5 | Initially normal 8 hrs incoordination 24 hrs splayed legs, tremour incoordination 48-72 hrs head tremour slight improvement | Meninges C.S.F. | - | Lepto/pachymeningeal infiltration by neutrophils and mononuclear cells. Severe destruction of molecular layer of cerebellum with vacuole formation |

PLATE 7.7

PIG WITH SIGNS OF PADDLING AND OPISTHOTONUS AFTER INJECTION
WITH THE HUMAN ISOLATE OF S. SUIIS TYPE 2 INTO THE C.S.F.



infected with the low dose (8×10^2), one pig that received the non-capsulated strain and the two control pigs.

Only the two pigs with the "classical" nervous signs showed gross pathological changes of the brain in which the meninges were opaque and oedematous. On histopathological examination, these pigs also had the most severe lesions of acute suppurative meningoenkephalitis. There was extensive leptomenigeal and pachymenigeal infiltration by neutrophils and some mononuclear cells, with severe destruction of the molecular layer and Purkinje's layer in the cerebellum (Plate 7.8). Most other pigs showed occasional glial nodule formation and infiltration of mononuclear cells in the brain (Plate 7.9). However, some glial nodules were also found in one of the control pigs.

DISCUSSION

Previous workers have recorded difficulties in consistently reproducing disease in pigs after artificial infection with S. suis type 2 (Friend and Sims, 1976; Clifton-Hadley and Alexander, 1981). These difficulties were demonstrated earlier in this chapter in relation to intranasal and intravenous infection of pigs. As Clausen (1980) found that meningitis could only be produced in pigs after subarachnoid inoculation, it was decided to infect some pigs by this route. Although an inconsistent production of clinical signs was again demonstrated, some important factors were recognized in the pattern of disease.

In the present experiment, three different isolates of S. suis type 2 were used. Only the isolate cultured from a human was capable of reproducing the "classical" clinical disease. Pedersen et al (1981) also demonstrated that S. suis type 2 isolated from humans was pathogenic for pigs, when administered by the intradermal and subcutaneous routes. Strains of S. suis type 2 isolated from pigs, appeared non-pathogenic even when administered at comparable doses to the human isolate. This would indicate that the pathogenicity of isolates of S. suis type 2 can vary. Further evidence to support this variable pathogenicity will be discussed in the next section of this chapter. The human strain was presumed to have originated from pigs as the patient enjoyed eating pork and would frequently cut up pig heads

PLATE 7.8

MENINGITIS OBSERVED IN A PIG WITH CLINICAL SIGNS INFECTED
WITH THE HUMAN ISOLATE OF S. SUIIS TYPE 2 INTO THE C.S.F.

Magnification x 25

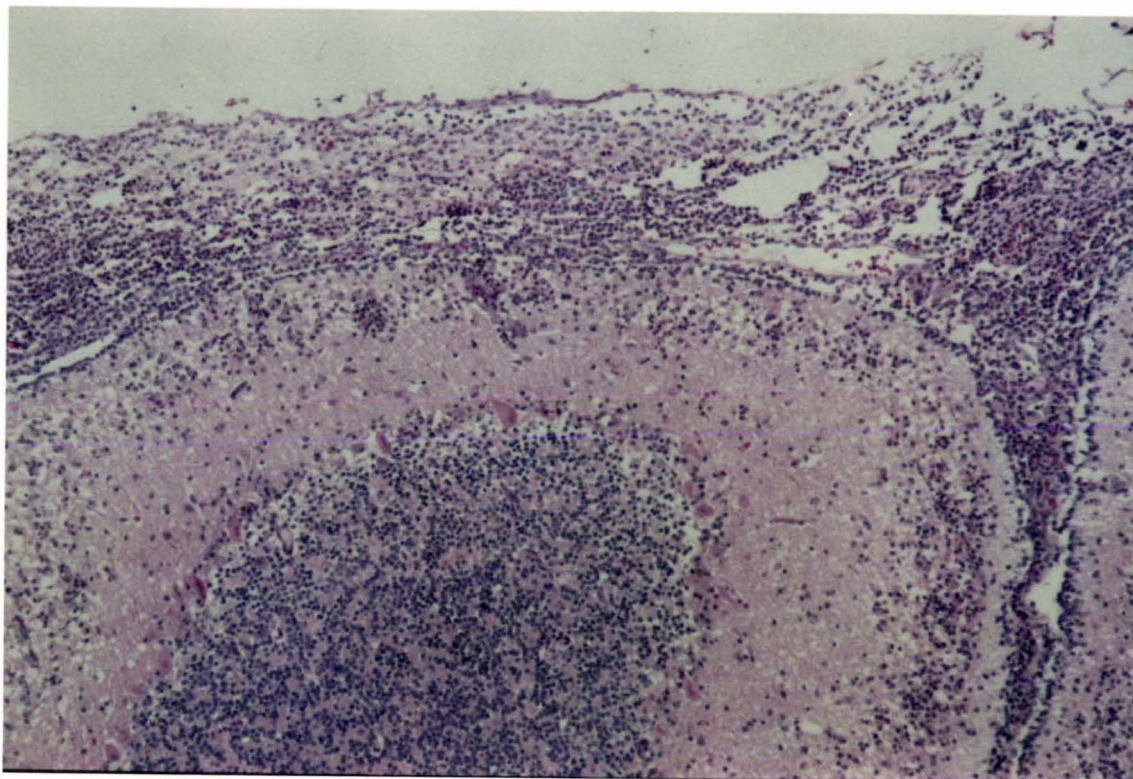
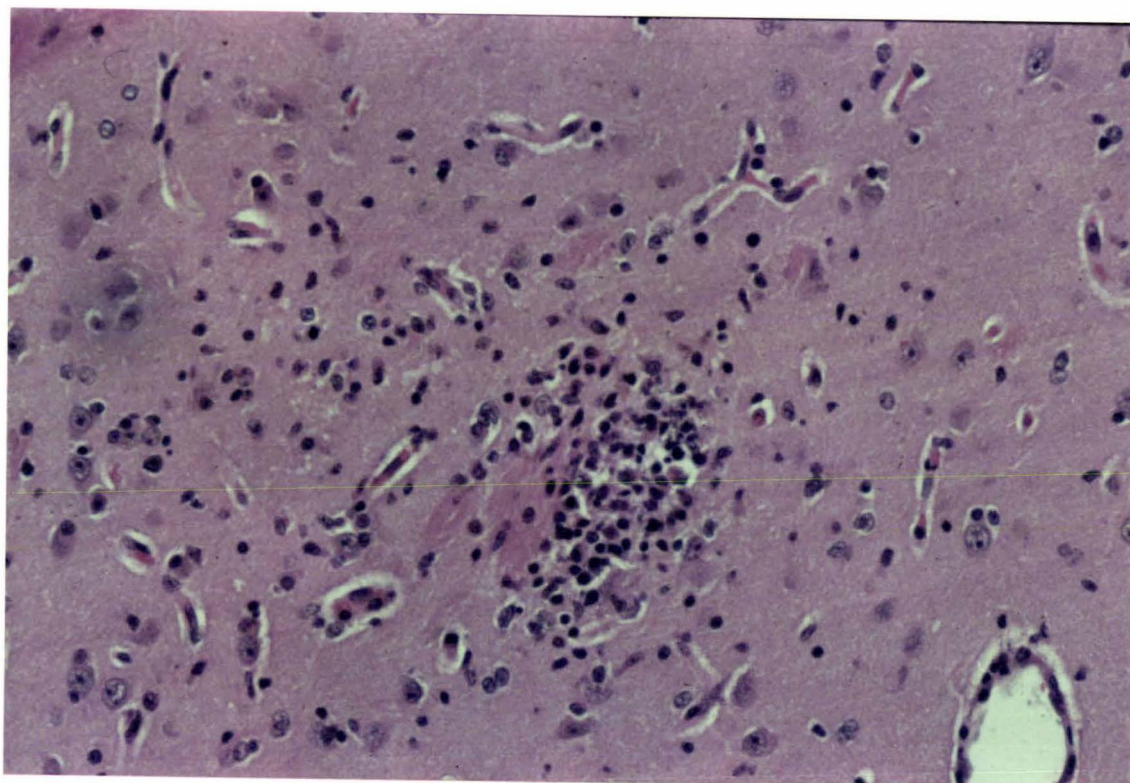

PLATE 7.9

A GLIAL NODULE IN A PIG WITHOUT CLINICAL SIGNS AFTER INFECTION
WITH A PORCINE ISOLATE OF S. SUIIS TYPE 2

Magnification x 62.5



for meat. The region from where this person originated does not have a higher morbidity or mortality rate of nervous or arthritic disease in pigs than does the rest of New Zealand. This may indicate that certain pathogenic strains of S. suis type 2 may not be carried by 100% of pigs unlike the "non-pathogenic" strains, or that if pathogenic strains are present in all pigs, secondary factors are needed for the development of clinical disease.

The presence of mild histopathological changes in the pigs inoculated with porcine isolates of S. suis, was probably associated with the injection of foreign material rather than the organism itself, as one control pig also developed these changes. Similarly, the initial excitability after infection was also seen in one control pig. The two pigs infected with the human strain appeared normal two to three hours after anaesthesia indicating that the signs subsequently seen were caused by the organism rather than from the inoculation technique. The isolation of S. suis type 2 from the brain or meninges of apparently normal, yet infected pigs, is identical to the findings reported earlier. It would appear that S. suis type 2 can be present in the meninges without causing overt clinical signs. Secondary factors may therefore be needed for the development of clinical disease or some strains of S. suis type 2 may not be pathogenic for pigs. However, as the porcine isolate was the same one that produced nervous signs in a pig infected via the intravenous route, it would appear that this isolate can be pathogenic but only in particular circumstances.

Streptococcus suis type 2 were also isolated from the blood of two pigs infected with the low dose (8×10^2). The bacteraemia in these pigs was detected three and five days after infection. This bacteraemia may have arisen from the inoculation, either if part of the dose had been accidentally injected into a blood vessel or if organisms had entered the blood stream from the brain, or alternatively it could have been a totally unconnected finding. In Chapter V, 10% of weaner pigs were found to have a bacteraemia of S. suis type 2. At this prevalence rate, there is a one in four chance of detecting a bacteraemia in two of the 16 inoculated pigs. Therefore it is quite possible that these bacteraemias were unrelated coincidental findings.

From these results it is obvious that the detection of S. suis type 2 from the brain of either normal or diseased pigs does not necessarily infer that S. suis type 2 was a causal agent of disease. The presence of this organism in a diseased brain could be purely coincidental and therefore microbiological results that include the isolation of S. suis type 2 should be treated with caution. However in the present experiment, the sudden onset of clinical signs in the pigs inoculated with a human strain and the lack of clinical disease in pigs infected with porcine strains would support the belief that some strains of S. suis type 2 are more virulent than others.

CONCLUSIONS

1. Different strains of S. suis type 2 have different degrees of pathogenicity for pigs.
2. Other factors, besides the presence in the brain of porcine strains of S. suis type 2, are needed for clinical disease to develop in pigs.
3. Isolation of S. suis type 2 from the brain of pigs does not necessarily imply the presence of a pathological process.

INFECTION OF LABORATORY ANIMALS WITH STREPTOCOCCUS SUIS

INTRODUCTION

Streptococcus suis types 1 and 2 have mainly been associated with diseases of pigs, with S. suis type 2 only rarely being a zoonotic agent and producing disease in humans or other animals (Robertson, 1986).

Field et al (1954) and Strojna et al (1978) reported that S. suis type 1 was non-pathogenic for mice, guinea pigs and rabbits when inoculated by the subcutaneous, intra-peritoneal, intravenous and intracranial routes. However, Zhelev et al (1960) produced disease in mice following intraperitoneal inoculation of an unspecified

diplococcus isolated from piglets with meningoencephalitis (presumably S. suis type 1). Hont and Banks (1944) also produced some fatalities in mice following intraperitoneal infection with a strain of streptococci (biochemically similar to S. suis), isolated from a pig with endocarditis. McErlean (1956) was able to infect young rabbits, mice and guinea pigs with a streptococcus isolated from piglets with meningo-encephalitis. He showed that the organism had a tendency to infect the brain and joints of the laboratory animals examined.

Streptococcus suis type 2 has also been isolated from a raccoon dog (Nyctereutes procyonoides) that died suddenly without showing any clinical illness. The animals diet included uncooked pig meat from pigs which had died. These pigs originated from piggeries with endemic streptococcal meningitis. On necropsy of the raccoon dog, there were no gross lesions other than a slight alveolar emphysema. However on bacteriological examination a heavy growth of S. suis type 2 was obtained from the liver and cerebrum. Other raccoon dogs, wolves (Canis lupus) and lynxes (Felis lynx) which had also been fed similar pig meat, failed to show any clinical signs (Keymer et al, 1983). To investigate the possible role of dogs acting as carriers of S. suis type 2, tonsillar swabs were taken from four domestic dogs on a pig farm with a history of disease from S. suis type 2. Although S. suis type 2 was not isolated, Keymer et al (1983) believed that S. suis type 2 should be considered a potential pathogen of domestic dogs in pig rearing areas and they believed there were possible dangers in feeding uncooked pig meat to carnivores.

The aim of the present experiment was to determine if S. suis was capable of producing disease in laboratory animals and to investigate if there were differences in the pathogenicity of isolates of S. suis for these animals.

MATERIALS AND METHODS

Experimental Animals

Laboratory mice (N.O.S.), rats (Sprague Dawley), guinea pigs and rabbits (New Zealand whites) were infected with S. suis in this experiment. The mice were six to twelve weeks old, the rats and guinea

pigs ten weeks old and the rabbits 12 to 26 weeks old. Female guinea pigs and rats were used, however the mice and rabbits were of both sexes. All animals were apparently healthy prior to experimentation. The mice, rats and guinea pigs all originated from the Small Animal Breeding Colony, Massey University, whilst the rabbits were obtained from two local breeders with the same genetic stock.

All stock were housed in a heated isolated room and regularly examined for evidence of clinical signs of disease. Animals that survived were autopsied within three weeks of infection, except for the offspring of some of the infected mice born during the experiment, which were killed between the age of one day and one month. Mice, rats and guinea pigs were euthanased by gassing in a carbon dioxide chamber, whilst rabbits were destroyed with an intravenous injection of sodium pentobarbitone. The liver, kidney, spleen, heart blood, brain and the major joints (hip, shoulder, stifle and elbow) were cultured from each animal autopsied.

Infection Procedure

In these experiments, field strains of both S. suis types 1 and 2 were used. These had been isolated from the palatine tonsils of apparently healthy pigs and a human strain isolated from a patient with bacteraemia. The isolates were grown overnight in Todd Hewitt Broth and the number of organisms present in each ml of broth determined by the technique described in Chapter IV. The culture was either diluted in phosphate buffered saline or injected directly into the laboratory animals.

Mice were infected by either the intraperitoneal route or by an intravenous injection into the coccygeal vein. Rats and guinea pigs were infected by direct intra-cardiac injection. They received the same dose as that given to the mice. All rabbits were infected by an intravenous injection into the marginal ear vein. Prior to inoculation, xylene was rubbed on the ear to produce vasodilation of the veins.

Porcine strains of S. suis

Eleven mice were intravenously inoculated with 0.1 ml containing 1.2×10^7 organisms of the porcine strain of S. suis type 2. Rats and guinea pigs were infected with 6×10^7 organisms in a volume of 0.5 ml. Four rabbits were infected with 6×10^7 S. suis type 2. One of these rabbits received a second dose of 1.2×10^7 S. suis type 2, 14 days after the initial infection. Another three rabbits initially received 6.6×10^7 organisms of S. suis type 1 followed by 1.2×10^7 S. suis type 2 eight days later.

Human strain of S. suis type 2

Fourteen mice were inoculated with 0.1 ml containing 4.6×10^7 organisms in 0.1 ml, nine with 23×10^7 (0.5ml), ten with 7.2×10^6 , ten with 1.8×10^4 and ten with 45 organisms (0.1 ml) by the intravenous route. The intraperitoneal route was also used with ten mice receiving 4.6×10^7 organisms (0.1 ml), eight with 23×10^7 (0.5ml), seven with 7.2×10^6 , 14 with 1.8×10^4 and ten with 45 organisms (0.1 ml). Rats and rabbits were infected with 23×10^7 organisms of S. suis type 2 in a volume of 0.5 ml.

RESULTS

Mice, Rats and Guinea Pigs

Table 7.11 summarizes the morbidity and mortality associated with infection by S. suis in the laboratory animals. No clinical signs were observed in the mice, rats and guinea pigs that received the porcine strains of S. suis type 2. However, two rats died immediately after being injected with this isolate. One rat had a haemopericardium and the other was believed to have died from anaphylactic shock. Streptococcus suis type 2 were isolated from the heart, blood and liver of both these rats. Streptococcus suis type 2 was not cultured from any of the other mice, guinea pigs and rats inoculated with this porcine strain. Clinical signs of disease and deaths occurred in the mice infected with the human strain of S. suis type 2. Signs of twitching, head bobbing and violent head movements were recorded from some (31%) of the mice infected by either the intravenous or

TABLE 7.11

A SUMMARY OF THE FINDINGS IN LABORATORY ANIMALS INOCULATED WITH S. SUIS

| LABORATORY ANIMAL | NUMBER OF ANIMALS | NUMBER OF ORGANISMS INOCULATED | ROUTE OF ADMINISTRATION | NUMBER WITH CLINICAL DISEASE (%) | NUMBER OF DEATHS (%) | NUMBER WITH POSITIVE CULTURES (%) |
|--------------------------------------|-------------------|--|-------------------------|----------------------------------|----------------------|-----------------------------------|
| PORCINE <u>S. SUIS</u> TYPE 2 | | | | | | |
| Rabbits | 3 | 6×10^7 | Intravenous | 3 (100) | 2 (67) | 3 (100) |
| Rabbits | 1 | 6×10^7 | Intravenous | 1 (100) | 0 (0) | 0 (0) |
| Rats | 4 | 6×10^7 | Intracardiac | 0 (0) | 2*(50) | 2*(50) |
| Guinea pigs | 4 | 6×10^7 | Intracardiac | 0 (0) | 0 (0) | 0 (0) |
| Mice | 11 | 1.2×10^7 | Intravenous | 0 (0) | 0 (0) | 0 (0) |
| PORCINE <u>S. SUIS</u> TYPE 1 | | | | | | |
| Rabbits | 1 | 6.6×10^7 | Intravenous | 0 (0) | 0 (0) | 0 (0) |
| PORCINE <u>S. SUIS</u> TYPES 1 and 2 | | | | | | |
| Rabbits | 2 | 6.6×10^7 1.2×10^7 | Intravenous | 1 (50) | 0 (0) | 0 (0) |

(CONTINUED)

TABLE 7.11 (CONTINUED)

| LABORATORY ANIMAL | NUMBER OF ANIMALS | NUMBER OF ORGANISMS INOCULATED | ROUTE OF ADMINISTRATION | NUMBER WITH CLINICAL DISEASE (%) | NUMBER OF DEATHS (%) | NUMBER WITH POSITIVE CULTURES (%) |
|------------------------------------|-------------------|--------------------------------|-------------------------|----------------------------------|----------------------|-----------------------------------|
| HUMAN <u>S. SUIS</u> TYPE 2 | | | | | | |
| Rabbits | 3 | 23×10^7 | Intravenous | 3 (100) | 2 (67) | 3 (100) |
| Rats | 4 | 23×10^7 | Intracardiac | 1 (25) | 2*(50) | 2*(50) |
| Mice | 9 | 23×10^7 | Intravenous | 4 (44) | 1 (11) | 8 (89) |
| Mice | 14 | 4.6×10^7 | Intravenous | 3 (21) | 0 (0) | 7 (50) |
| Mice | 10 | 7.2×10^6 | Intravenous | 1 (10) | 0 (0) | 4 (40) |
| Mice | 10 | 1.8×10^4 | Intravenous | 0 (0) | 0 (0) | 2 (20) |
| Mice | 10 | 45 | Intravenous | 0 (0) | 0 (0) | 0 (0) |
| Mice | 8 | 23×10^7 | Intraperitoneal | 6 (75) | 1 (12) | 4 (50) |
| Mice | 10 | 4.6×10^7 | Intraperitoneal | 3 (30) | 0 (0) | 2 (20) |
| Mice | 7 | 7.2×10^6 | Intraperitoneal | 1 (10) | 0 (0) | 2 (20) |
| Mice | 14 | 1.8×10^4 | Intraperitoneal | 0 (0) | 0 (0) | 0 (0) |
| Mice | 10 | 45 | Intravenous | 0 (0) | 0 (0) | 0 (0) |

* - Includes rats dying from injection technique

intraperitoneal routes with more than 10^6 organisms. Streptococcus suis type 2 was isolated from either or both the blood or brain of 15 of the 18 mice with clinical disease and 12 of the 84 apparently normal mice. Eight mice (two infected with porcine isolates and six with human isolates) which were pregnant at the time of infection had apparently normal litters. These pregnant mice included two which had developed clinical signs after intraperitoneal infection with the human isolate. The offspring of these mice appeared healthy and developed in a normal manner. Streptococcus suis type 2 could not be cultured from any of the offspring. There was no significant difference between the number of mice developing clinical disease in the intraperitoneal infected group and the intravenous infected group ($p > 0.4$). No histopathological abnormalities could be detected in the brains of the mice examined with clinical signs.

One of the rats infected with the human isolate died within one hour of infection. This rat also had a haemopericardium. However another rat developed signs of lethargy and depression, and S. suis type 2 was cultured from all the body organs and joints examined.

Rabbits

Two of the four rabbits infected with one dose of the porcine isolate of S. suis type 2 were depressed, anorectic and not drinking two days after inoculation. One of these rabbits subsequently died three days after infection. This rabbit had congested lymph nodes, parenchymatous organs and subcutaneous tissues, an excess of peritoneal fluid and petechial haemorrhages on the epicardium and myocardium. The knee joints were hyperaemic with an excess of joint fluid, however the other joints appeared normal. Streptococcus suis type 2 was isolated from the joints, and all body organs examined. The second rabbit died four days after infection. This rabbit had congested hyperaemic lymph nodes with excessive pericardial and pleural fluid. Streptococcus suis type 2 was again isolated from the joints and body organs. One hip joint showed signs of congestion and hyperaemia, the other joints appeared normal. Five days after artificial infection, the other two rabbits that received the porcine isolate were lame, depressed and not eating or drinking. Blood collected from these rabbits four, five and six days after infection

was negative for S. suis type 2. One of these rabbits was subsequently euthanased seven days after infection. On autopsy, a purulent arthritis was found in one stifle joint, however the rest of the carcass appeared macroscopically normal. Streptococcus suis type 2 was isolated from the affected stifle joint. All other tissues and joints were sterile. The remaining rabbit was lame for another two weeks, however its appetite returned two days after the onset of clinical signs. This rabbit subsequently was infected with a second dose of the porcine isolate of S. suis type 2.

No obvious clinical signs were seen in the three rabbits that were initially infected with S. suis type 1. No gross pathological abnormalities or organisms could be detected when one of these rabbits was euthanased two weeks after infection. The two remaining rabbits and the rabbit that survived the initial infection with S. suis type 2 were subsequently inoculated with the porcine isolate of S. suis type 2. One of the rabbits that received both S. suis types 1 and 2 was lame, depressed and had a reduced appetite after the second inoculation. This lameness was observed for up to one week after infection. The other two rabbits remained apparently normal. No gross pathological abnormalities were detected when the three rabbits were autopsied two weeks after the second inoculation. No S. suis types 1 and 2 were isolated from any of these rabbits.

After intravenous infection with the human isolate of S. suis type 2, all four rabbits developed clinical signs. Three of these rabbits died one, two and four days after infection. All rabbits showed extensive subcutaneous haemorrhages and congestion of the parenchymatous organs. Streptococcus suis type 2 was cultured from all the organs and joints sampled in these three rabbits. Four days after infection, the fourth rabbit appeared to recover and continued to eat and drink normally until autopsied. No gross pathological changes or S. suis type 2 could be detected in this rabbit.

DISCUSSION

Although the pathogenicity of S. suis types 1 and 2 for pigs has been widely reported, there are only a few studies on the pathogenicity of these organisms for laboratory animals and the

results are conflicting. In this experiment it was found that a porcine isolate of S. suis type 2 was non-pathogenic for mice, rats and guinea pigs when administered by the intravenous route. However, a human isolate of S. suis type 2 was pathogenic for mice when administered by either the intravenous or intraperitoneal route and for rats when administered by the intravenous route. Although mice infected with over 10^7 organisms of this human isolate had only a 5% (2/41) mortality rate, the morbidity rate was 39% (16/41). Affected mice had a permanent neurological dysfunction until they were euthanased. In mice infected with the human strain, there appeared to be a dose response for the development of clinical signs. All mice that developed clinical disease were inoculated with more than 10^6 organisms. Inoculation with S. suis type 2 and the development of clinical signs in pregnant mice, had no effect on the survival of their subsequent litter. This would indicate that there was probably neither transplacental nor transmammary spread of infection of S. suis type 2.

No inflammatory response could be detected in histological sections of the brains of mice with nervous signs. This may indicate that, for mice, the organism causes a specific lesion in one particular region of the brain, rather than generalized pathological changes. The histological sections observed in the present study, may not have included these specific areas and hence the brain appeared normal. In humans, it has been proposed that S. suis type 2 produces a neurotoxin that acts specifically against the eighth cranial nerve (Chau et al, 1983). In the present experiment, if damage was caused by a specific neurotoxin, then a generalized inflammatory response would not be expected in the brains of the mice. Several mice did show signs of circling and upset balance which may support this hypothesis, however it is equally possible that middle ear damage could also cause these signs.

Both porcine and human isolates of S. suis type 2 were pathogenic for rabbits when administered by the intravenous route. However, rabbits that were infected with S. suis type 1 did not develop any obvious clinical signs. All rabbits infected with S. suis type 2 developed clinical signs of disease. The porcine isolate produced a 50% (2/4) mortality rate whilst the mortality rate for the human isolate was 75% (3/4). On autopsy of infected rabbits, there was a

"septicaemia" with widespread dissemination of S. suis type 2 through the carcass. It appears that S. suis type 1, at the dose rate used and via the intravenous route, was non-pathogenic for rabbits. However, it did appear to elicit some response protecting the rabbits against subsequent infection with S. suis type 2. No deaths and only a 50% (1/2) morbidity rate were recorded in rabbits initially inoculated with S. suis type 1 followed by inoculation with S. suis type 2. One rabbit that survived the initial infection with the porcine isolate of S. suis type 2, also demonstrated some protection against subsequent reinfection with this type. However with the small number of rabbits used in these experiments, such apparent differences must be treated with caution.

Group E streptococci from pigs were also believed to be non-pathogenic for laboratory animals (Coffey, 1942; Deibel et al, 1964). However Cutlip and Shuman (1971) demonstrated that after intravenous inoculation, rabbits showed signs of lethargy, anorexia and osteoarthritis. Similar signs were seen in the rabbits that survived the infection with S. suis type 2, however the majority of rabbits showed obvious signs of clinical disease. Mogabgab and Thomas (1952) reported that less than 10% of rabbits died after an intravenous inoculation with massive doses of group A streptococci. They proposed that a mechanism existed in the normal rabbit for removal of streptococci from the bloodstream. This mechanism was found to be incapacitated in rabbits treated with cortisone and these rabbits subsequently succumbed to streptococcal infections. In the present experiment rabbits appeared highly susceptible to infection with S. suis type 2, with a morbidity rate of 100% and a mortality rate of greater than 50%. However they appeared resistant to infection with S. suis type 1.

An organism, biochemically identical to S. suis type 2, had also been isolated from an eight week old lamb that died suddenly and had been submitted to the Department of Veterinary Pathology, Massey University. On autopsy, this lamb was found to have a severe valvular endocarditis and streptococci were isolated in pure culture from the heart valve, liver and kidney. A Lancefield extract, prepared from this organism, did not precipitate group R antiserum. However this organism could have belonged to one of the biochemically similar, yet serologically different, S. suis as described by Perch et al (1983).

This lamb was believed to have had no contact with pigs and grazed more than one km from a piggery. The finding of a S. suis like organism in a lamb, the isolation of S. suis type 2 from a raccoon dog (Keymer et al, 1983) and the results reported here would indicate that under certain circumstances, S. suis may well be pathogenic for animals other than pigs.

In the present investigation, the variable responses found after artificial infection of laboratory animals, may indicate genetic differences in the susceptibility of various species and strains of laboratory animals to streptococcal infections or differences in the pathogenicity of isolates of S. suis. As the mice and rats infected with the human and porcine strains of S. suis type 2 were of similar genetic line, it is unlikely that the differences seen after infection were of genetic origin. With the mice and rats, the differences in the development of clinical disease for the two isolates of S. suis type 2 is best explained by differences in pathogenicity. Rabbits would appear to be susceptible to infection by both isolates.

CONCLUSIONS

1. Different strains of S. suis type 2 exist with differing pathogenicities for laboratory animals. An isolate from a human caused disease in mice, rats and rabbits whilst porcine isolates only produced disease in rabbits.
2. Streptococcus suis type 2 appeared to be more pathogenic for rabbits than for mice, rats and guinea pigs.
3. Initial infection with S. suis types 1 or 2 may provide some protection for rabbits against a subsequent inoculation with S. suis type 2.
4. Streptococcus suis type 1 appears to be less pathogenic for rabbits than S. suis type 2.

CHAPTER VIII

PUBLIC HEALTH ASPECTS OF STREPTOCOCCUS SUIS TYPE 2

INTRODUCTION

Human infection with group R streptococci (S. suis type 2) was first reported in 1968, when three cases of meningitis with concurrent septicaemia were diagnosed in Denmark (Perch et al, 1968). Subsequently cases have also been reported from Holland, France, England, Wales, Hong Kong, Canada and New Zealand (Ancelle et al, 1977; Paul et al, 1977; Anon, 1978b; Joynson, 1980; Anon, 1982b; Sanford and Tilker, 1982; Chau et al, 1983; Zanen, 1983; Dickie et al, 1987). Although S. suis type 2 is endemic in most pig rearing countries including Australia and New Zealand, the disease in humans has not been reported from many countries. In this chapter a summary will initially be given of the findings of other workers on the infection of humans with S. suis type 2. This will be followed by the results of a cross sectional serological survey looking for antibodies against S. suis type 2 in different occupational groups and a discussion of the public health implications of these findings.

Streptococcus suis type 2 is a rare zoonotic agent with less than 100 cases reported in the literature (Robertson, 1986). Constable and Harrington (1982) and Walton (1983) reported a morbidity rate of 9 cases per 100,000 years of veterinary work. This is one of the lowest rates for any zoonosis to which veterinarians are exposed. Even though S. suis types 1 and 2 produce a similar syndrome in pigs, there have been no reported cases of infection of humans with S. suis type 1 (Anon, 1978a; Clements et al, 1982).

Historically, streptococcal meningitis in adults has been considered uncommon (Lerner, 1975). However, Chau et al (1983) recognized that S. suis type 2 was the most frequent cause of bacterial meningitis in adults in Hong Kong. As group R streptococcal antiserum is not used routinely in medical laboratories, it has been suggested that the disease may be under diagnosed. The bacterium could be mistaken for S. viridans, S. pneumoniae, enterococci or even

Listeria monocytogenes (Avril et al, 1977; Chattopadhyay, 1979; Joynson, 1980; Chau et al, 1983).

Infection of humans with S. suis type 2 results in a meningitic/septicaemic condition similar to that in pigs. The meningitis is usually accompanied by permanent vestibular and auditory dysfunction (Zanen and Engel, 1975). Early loss of hearing is a prominent feature of the disease and is believed to be caused by the production of a specific ototoxin (Chau et al, 1983). Chattopadhyay (1979) proposed that S. suis type 2 had a special affinity for the meninges and especially the cochlear division of the eighth cranial nerve. Other complications of infection of humans with S. suis type 2 have included arthritis (Hickling and Cormack, 1976; Cheng et al, 1987), uveitis and endophthalmitis (Agass et al, 1977; McLendon et al, 1978). Although the major clinical signs are meningitis and septicaemia, septicaemia without meningitis has been recorded (Kloppenburger et al, 1977; Dickie et al, 1987).

The majority of reported cases of infection with S. suis type 2 in humans have involved adults who handled pigs or their meat products. This included butchers, meat inspectors, pig farmers and abattoir workers (Perch and Kjems, 1971; Koldkjaer and Nielsen, 1972; Clements and Hamilton, 1981; Twort, 1981; Zanen, 1983). Peel et al (1979) reported disease in a veterinarian who had dealt with outbreaks of streptococcal meningitis in pig herds. Several cases have also been reported where there was no history of direct contact with live pigs, including one woman who frequently eat raw pork balls (Chattopadhyay, 1979).

Reported cases have provided strong evidence to indicate a percutaneous route of infection. Injuries, minor cuts and abrasions have frequently been recorded two to three days prior to the onset of clinical signs (Zanen and Engel, 1975; Chau et al, 1983). Kloppenburger et al (1975) reported that a female assistant butcher subsequently developed disease after injuring herself with a pork chop bone.

Breton et al (1986) investigated the contamination of hands and knives of abattoir workers with S. suis. They reported that most isolates of S. suis were from the people working in the lung evisceration area. Although many isolates of S. suis that could not be

typed were detected, only two isolates of S. suis type 2 were found. One of these isolates came from an eviscerators knife and the other from a butchers knife in the "cut-up room". The isolate from the butchers knife indicated that S. suis type 2 was capable of surviving in chilled meat. The workers found that there was a seven times greater chance of detecting S. suis on an eviscerators knife than on a butchers knife. Similarly, the likelihood of isolating S. suis from an eviscerators hand was four times greater than from a butchers hand. On the basis of these findings, they suggested that some groups of abattoir workers are more at risk from infection by S. suis type 2 than others.

Although only a few affected people have died (Perch et al, 1968; Zanen and Engel, 1975), the permanent hearing loss and problems of balance are serious sequelae of infection with S. suis type 2. As most strains are susceptible to penicillin, this antibiotic has been recommended for treatment of human cases. However, Shneerson et al (1980) reported one isolate of S. suis type 2 that was resistant to penicillin and Clements et al (1982) found some isolates resistant to sulphonamides. Even with treatment early in the course of disease, the vestibular and auditory dysfunction is frequently permanent (Chau et al, 1983).

Chau et al (1983) recorded a peak incidence of human cases in the summer months in Hong Kong. They proposed that the populations preference for fresh pork, the large numbers of pigs imported into the country and the hot, humid summers allowed for either the rapid spread of S. suis type 2 between pigs or the multiplication of the bacterium within pig meat and viscera.

Although Heard (1984) proposed that S. suis type 2 could possibly survive in the nasal tract of man, the tonsils of thirty-four workers who handled pigs and their meat and byproducts at a slaughter house, were all negative for the bacterium (Arends et al, 1984). It would appear that the major risk, although small, is from contact with pigs or their meat products (Clifton-Hadley et al, 1983a). The chances of contracting an infection with S. suis type 2 may be further reduced by wearing gloves whilst autopsying dead pigs, covering cuts and abrasions and by washing with soap and water after handling sick pigs (Anon, 1980; Clifton-Hadley, 1982).

MATERIALS AND METHODS

Elisa

The ELISA described earlier in Chapter III was used to detect the presence of antibodies to S. suis type 2. An antigen dilution of 1/32 and a conjugate dilution of 1/2000 were used with four doubling dilutions of sera from 1/50 to 1/400.

Sera

The sera tested in this trial was obtained from frozen stocks used by Blackmore and Schollum (1982a, b, c) to study the serological response of occupational exposure to leptospirosis. Sera was used from 70 pig farmers, 96 dairy farmers, 107 meat inspectors and 16 veterinary students. The sex, age and duration of occupational contact with pigs were available for all groups. Additional information was available for pig farmers on the type and size of piggery, whether or not pigs were killed at home and if pigs were introduced from other farms. Information was also available for dairy farmers on the number of pigs kept and if pigs were killed on the farm, and for meat inspectors on contact with pigs outside working hours, including the hunting of feral pigs.

Determination of antibody titre

The antibody titre of each sera was calculated by the method described for pig sera in Chapter V. The cut-off point between a positive and negative titre was determined by studying the pattern of titres in sera collected from people with no exposure to pigs and therefore presumed to have little or no contact with S. suis type 2. As all sera of these people had titres below 1/400, this antibody level was used as the cut-off point for further studies.

RESULTS

Figure 8.1 is a histogram of the percentage of sera with different titres for each of the four occupational groups. Most titres were below the 1/400 level selected as the cut-off value. Five meat inspectors and one dairy farmer had titres greater than 1/1000 whilst no pig farmers or veterinary students had titres as high as this. The meat inspectors with these high titres all had occupational contact with pigs or their products and the dairy farmer kept pigs on his farm.

In Table 8.1 the number and proportion of people in each occupational group with positive titres is recorded. With pig farmers 21.4% had titres greater than 1/400, as did 9.3% of dairy farmers and 10.3% of meat inspectors. No veterinary students had positive titres and none had a history of contact with pigs. There was a significant difference ($p < 0.05$) between the number of people positive to S. suis type 2 in the different occupational groups.

Table 8.2 records the number of people with positive or negative titres to S. suis type 2 and their exposure to certain variables. For people living on pig farms, there was a significant correlation between a positive titre and contact with pigs ($p < 0.05$). There was no significant difference ($p > 0.05$) between the titres of dairy farmers with pigs and those without pigs, and for meat inspectors with pig contact and those without pig contact. However there was an obvious trend towards more positive titres in the groups with pigs or those with pig contact compared with those without. Similarly there was no significant difference between the titres of pig farmers who killed pigs and those who did not kill pigs, although there were more positive titres in the former group. The period a person had been either a pig or dairy farmer had no relationship to a positive titre to S. suis type 2. Similarly there was no apparent pattern or a significant difference between the number of positive and negative titres for the following groups: pig farmers with either more or less than 400 pigs; pig farmers who either purchased or did not purchase weaner pigs; pig farmers who farmed pigs intensively or those that farmed pigs extensively; and dairy farmers and meat inspectors who did or did not have contact with feral pigs.

FIGURE 8.1

THE RANGE OF TITRES TO S. SUIIS TYPE 2 IN DIFFERENT OCCUPATIONAL GROUPS

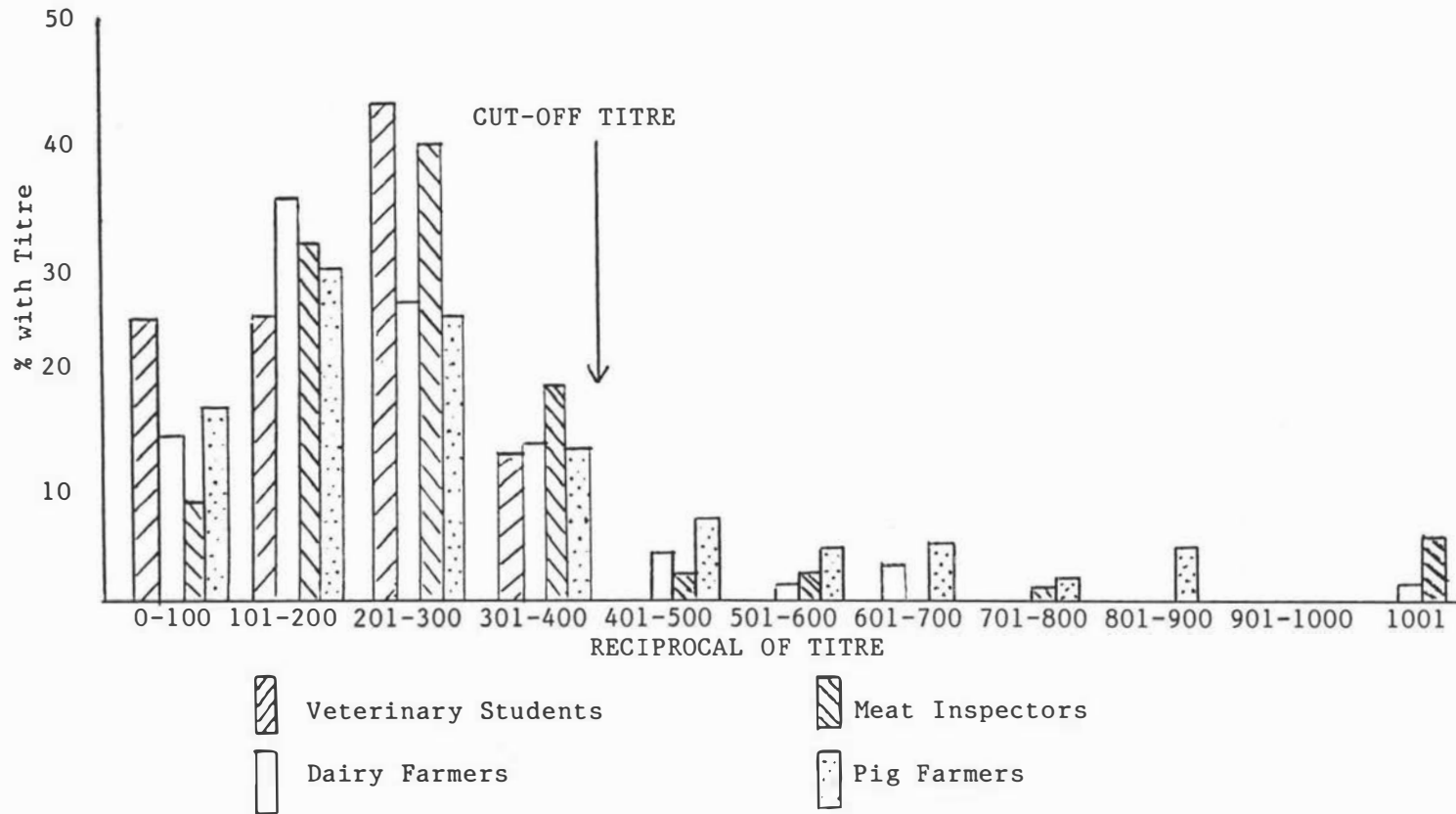

TABLE 8.1

PREVALENCE OF POSITIVE TITRES TO S. SUIIS TYPE 2
IN DIFFERENT OCCUPATIONAL GROUPS

| OCCUPATION | NUMBER POSITIVE | NUMBER NEGATIVE | TOTAL NUMBER TESTED |
|------------------------|--------------------|--------------------|---------------------------|
| Veterinary Students | 0 (0%) | 16 (100%) | 16 |
| Dairy Farmers | 9 (9.3%) | 87 (90.7%) | 96 |
| Meat Inspectors | 11 (10.3%) | 96 (89.7%) | 107 |
| Pig Farmers | 15 (21.4%) | 55 (78.6%) | 70 |

TABLE 8.2

THE RELATIONSHIP BETWEEN POTENTIAL RISK FACTORS
AND TITRES TO S.SUIS TYPE 2

| VARIABLE | NUMBER POSITIVE | NUMBER NEGATIVE | PROBABILITY ON CHI SQUARE TEST |
|--|--------------------|--------------------|--------------------------------------|
| Residents on Pig Farms with Pig Contact | 15 (21.4%) | 42 | $p < 0.05$ |
| Residents on Pig Farms without Pig Contact | 0 | 13 | |
| Dairy Farmers with Pigs | 7 (14%) | 43 | $p > 0.1$ |
| Dairy Farmers without pigs | 2* (4%) | 44 | |
| Meat Inspectors with pig contact | 9 (15%) | 52 | $p > 0.05$ |
| Meat Inspectors without pig contact | 2 (4%) | 44 | |
| Pig Farmers kill pigs | 4 (27%) | 11 | $p > 0.2$ |
| Pig Farmers don't kill pigs | 8 (15%) | 47 | |

(CONTINUED)

* - low titres of 406 and 417

TABLE 8.2 (CONTINUED)

| VARIABLE | NUMBER POSITIVE | NUMBER NEGATIVE | PROBABILITY ON CHI SQUARE TEST |
|-----------------------------------|--------------------|--------------------|--------------------------------------|
| Period of Pig Farming (years) | | | |
| 0 - 5 | 6 (19%) | 25 | |
| 6 - 10 | 3 (21%) | 11 | $p > 0.9\#$ |
| 11 | 6 (24%) | 19 | |
| Period of Meat Inspection (years) | | | |
| 0 - 5 | 6 (10%) | 51 | |
| 6 - 10 | 2 (7%) | 28 | $p > 0.6\#$ |
| 11 | 3 (15%) | 17 | |

- Highly non-significant

In Table 8.3 the number of people with positive titres for different age groups is recorded. There were no significant differences or apparent trends between the different age groups and the number of positive titres ($p > 0.25$ for pig farmers, $p > 0.6$ for dairy farmers and $p > 0.8$ for meat inspectors).

DISCUSSION

A titre of 1/400 was used as a cut-off for distinguishing between positive and negative sera. This titre was slightly greater than the highest value recorded from the group without exposure to pigs (1/308). This cut-off point appeared to be sufficiently specific as people who lived on pig farms and yet had no contact with the pigs also had titres lower than this. There was a significant difference between the titres for the four occupational groups. This would appear to arise from the different degree of contact with pigs and hence likely recent exposure to S. suis type 2, as pig farmers had more positive titres than any other occupational group. Although dairy farmers who owned pigs had a greater probability of having positive titres to S. suis type 2, it was not significant at the 0.05 level. Mackintosh et al (1982) found a significant association between titres to Leptospira interrogans serovar pomona in dairy farmers and the keeping of pigs. In the present study, if more sera from dairy farmers had been examined, it is possible that similar significant differences would have been demonstrated. The two dairy farmers who did have titres and yet did not keep pigs, had low titres of only 1/406 and 1/417, values that were just above the cut-off point. This may suggest that the "cut-off" value was too low. However increasing this value, although increasing the specificity, would have reduced the sensitivity of the test. It is believed that these two cases could well have been false positives.

Most cases of clinical disease have been reported in meat workers followed by pig farmers (Chattopadhyay, 1979), however in this study pig farmers had a greater proportion of positive titres than did meat inspectors. Although meat inspectors did record some of the highest titres to S. suis type 2. As meat inspectors routinely incise lymph nodes including those draining the tonsils, they would occasionally

TABLE 8.3

THE NUMBER OF POSITIVE TITRES TO S.SUIS TYPE 2
IN DIFFERENT AGE AND OCCUPATIONAL GROUPS

| OCCUPATION | TITRES | AGE in YEARS | | | | | |
|--------------------|----------|--------------|------------|------------|------------|-----------|------------|
| | | < 20 | 20-29 | 30-39 | 40-49 | 50-59 | > 60 |
| PIG FARMERS | Positive | 2 (25%) | 0 | 8 (27%) | 3 (25%) | 0 | 2 (50%) |
| | Negative | 6 | 4 | 22 | 9 | 10 | 2 |
| DAIRY FARMERS | Positive | 0 | 3 (14%) | 4 (16%) | 1 (5%) | 1 (6%) | 0 |
| | Negative | 5 | 19 | 21 | 21 | 16 | 5 |
| MEAT INSPECTORS | Positive | 1 (5%) | 7 (12%) | 3 (14%) | 0 | 0 | - |
| | Negative | 19 | 53 | 19 | 4 | 1 | - |

No significant difference in age prevalence $p > 0.2$

have direct contact with S. suis type 2. Breton et al (1986) found that meat workers involved in the evisceration of the carcasses, including the removal of the larynx and lungs, had a significantly higher risk of exposure to S. suis type 2 than did other abattoir workers. In the present investigation, pig farmers who slaughtered their own pigs also had a greater percentage of positive titres than farmers who did not slaughter pigs, however this was not statistically significant ($p > 0.2$). In the present investigation, there was a strong correlation between positive titres and contact with pigs. This would support the hypothesis that when infection of humans occurs, it originates from pigs. The apparent lack of any other maintenance host for S. suis type 2 would also support this hypothesis. Only a few cases of clinical disease in humans have been reported where no direct occupational contact with pigs or their products could be identified (Chattopadhyay, 1979). However, as one of these involved a woman who frequently eat raw pig meat, it would appear that handling pig meat in the home may also be a relevant yet rare risk factor.

Purchasing weaners, the type of piggery and the size of the herd had no effect on the prevalence of titres in pig farmers. These results contrast with those of Schollum and Blackmore (1982) who found a significant association between the presence of a leptospiral titre and the size of herd and type of piggery. Although the endemic level of infection with leptospires in pigs is also high (Ho and Blackmore, 1979), it would appear that the spread of infection of leptospirosis to humans is different to that with S. suis type 2. Leptospires are shed in the urine and therefore there are greater chances of pig farmers coming in contact with urine in intensive and large pig herds. Streptococcus suis type 2 appears to be spread via oral and nasal discharges. Therefore contact with pigs and feed troughs whether in an intensive or extensive piggery, or in a large or small herd, would still expose the farmer to this organism. The present findings could be anticipated, as it appears that actual contact with pigs is more important than any specific management practice. However if a pig herd is very small the probability of infection would be reduced. This could account for the low prevalence of titres recorded in dairy farmers and meat inspectors whose only contact with pigs was the hunting of feral pigs. These people would have only a short contact time with pigs and therefore only a very low risk of becoming infected by S. suis type 2.

Pig farmers who had farmed pigs for different lengths of time had similar percentages of positive titres. This pattern was also present in the meat inspectors. This could indicate that antibody levels are maintained for only short periods. If the duration of titres was long, there should be an increase in the proportion of positive titres with increased contact time with pigs. As this did not occur, it must be assumed that titres are of short duration. The finding that the proportion of positive titres did not increase in different age groups would also support this belief. This is in sharp contrast to leptospiral titres which increase both with age and the duration of work (Mackintosh et al, 1980). As leptospiral titres are estimated to have a duration of at least ten years (Blackmore et al, 1979), the prevalence would be expected to rise with age. Thus it would be reasonable to assume that titres to S. suis type 2 are of shorter duration than those to leptospire.

The present survey provides only prevalence data, however certain inferences can be made about the incidence of infection. If we assume that infection of humans with S. suis type 2 is stable in an ecological sense (constant endemic level), the prevalence will equal the product of the incidence and the duration of the disease ($P = I \times D$). For a disease to be stable, the incidence and duration must remain constant over time (MacMahon and Pugh, 1970). The duration of antibodies to S. suis type 2 must be less than five years, as there were no differences in the prevalence of titres in pig farmers who had worked 0 to 5 years, 6 to 10 years or greater than 10 years. With a prevalence of 21.4%, the annual incidence would be 4.3%, 5.4%, 7.1%, 10.7% or 21.4% if the duration of titres were 5, 4, 3, 2 or 1 years respectively. These levels are high when compared to the annual incidence of less than 3% for leptospirosis of pig farmers (Blackmore and Schollum, 1982c). If the duration of titres to S. suis type 2 in humans are similar to group A streptococci, one might assume an average duration of nine months (0.75 years) (Dudding and Ayoub, 1968). Thus from the formula $P = I \times D$, $21.4 = I \times 0.75$, the annual incidence of seroconversion and presumably infection with S. suis type 2 in pig farmers is 28.5%. This high level of incidence is unusual for most zoonotic diseases. In Constable and Harrington's (1978) study on the risks of zoonoses in veterinary services, animal derived ringworm was the most frequent zoonoses with an annual

incidence of 1.2% (1222 cases per 100,000 person/years). Robinson and Metcalfe (1976) also reported that dermatophytosis was the most common zoonotic infection in New Zealand veterinarians, with 26% of 81 infected at some stage of their career.

When the medical history of people with positive titres was investigated there was no consistent association with previous illness. Many of the cases of disease recorded were associated with leptospirosis. It would appear that subclinical infections of S. suis type 2 can occur in humans as well as in pigs. Subclinical infections would lead to the development of antibodies to S. suis type 2 similar to that recorded for subclinical throat infections of humans by group A streptococci (Maxted and Widdowson, 1972).

It is highly probable that strains of S. suis type 2 exist with different levels of pathogenicity for humans, similar to that found with pigs and laboratory animals. From the work in the preceding chapter, it appeared that some strains of S. suis type 2 were non-pathogenic for most animals whilst others were pathogenic for a variety of different species of animals. If some strains were infective but non-pathogenic for humans, there would be antibody production without the development of clinical disease, as was found in the present survey.

From the present study, it is obvious that contact with pigs is the major factor leading to antibody development to S. suis type 2. In Chapter V 3% of normal pigs slaughtered at a meatworks were shown to be carrying S. suis type 2 in the blood. As there is residual blood in all body tissues after slaughter and S. suis type 2 can survive in chilled and frozen pig products, a similar percentage of carcasses and their resultant meat cuts may also be infected. Therefore, it is possible that people handling and cooking pig meat within a household could also become infected and subsequently develop antibody. However, the total number of recorded cases of disease from S. suis type 2 in humans, other than those involved with pig farming, slaughtering or butchering, is less than five (Perch et al, 1968; Zanen and Engel, 1975; Chau et al, 1983). The public health dangers from handling meat infected with S. suis type 2 therefore appears to be extremely small. In Chapter IV, S. suis type 2 was found to be susceptible to heat, with all organisms destroyed after heating for two minutes at 60°C. As

the normal temperature for cooking pig meat is between 180 and 220°C (C. Robertson, personal communication), all S. suis present in the raw pig meat would be destroyed prior to ingestion of the cooked product.

The case reported by Dickie et al (1987) is interesting in that it records the first case of infection with S. suis type 2 in a person with a concurrent medical condition (insulin dependent diabetes). It is possible that this person either accidentally injected himself with pathogenic S. suis type 2 whilst administering insulin or that being a diabetic made him more susceptible to infection. Diabetics have been found to be more susceptible to group B streptococcal infections (Lerner et al, 1977). In retrospect, it would be interesting to know if other cases of disease have occurred in people with concurrent infections or diseases.

As infection of humans with pathogenic strains of S. suis type 2 has strongly incriminated a percutaneous route of infection, it is probable that infection by non-pathogenic strains is by the same route. As most farmers have cuts and abrasions on their hands and arms, there is a high risk of infection by S. suis type 2. The dispersed nature of S. suis type 2 within the piggery would also increase the possibility of contact between this organism and abraded skin. In the present study, there was no significant difference between the prevalence of titres in males and females, however the sera from only a small number of women was tested. Blackmore and Schollum (1982b) found that female milkers were less at risk of contracting leptospirosis than their male counterparts. They proposed that this might be associated with fewer cuts and abrasions in females, therefore reducing the possibility of percutaneous infection. A similar finding may have been expected in the present investigation, except that the possibility of infection from uncooked pig meat would have been greater in the females than the male workers.

CONCLUSIONS

1. In the four occupational groups studied, 21.4% of pig farmers, 10.3% of meat inspectors, 9.3% of dairy farmers were seropositive to S. suis type 2 whereas none of the veterinary students were seropositive.

2. Positive titres in humans to S. suis type 2 is related to occupational contact with pigs or their meat products and hence exposure to S. suis type 2.
3. Antibody to S. suis type 2 appears to be of short duration (less than five years).
4. The annual incidence of seroconversion and presumed infection with S. suis type 2 could be as high as 30% in pig farmers.
5. Subclinical infection with S. suis type 2 appears to occur in humans as well as in pigs.
6. Strains of S. suis type 2 of low pathogenicity for both humans and animals appear to be maintained in pigs.

CHAPTER IX

THE PREVALENCE OF STREPTOCOCCUS SUIIS IN QUEENSLAND PIGS

INTRODUCTION

Although S. suis type 1 was first recognized in Australian pigs in 1963 (Simmons, 1963) and S. suis type 2 in 1981 (Buddle *et al*, 1981), it is probable that these organisms were present much earlier (Friend and Sims, 1978; Buddle, 1985).

Losses attributed to infection with S. suis type 2 appear to vary from state to state in Australia (Buddle, 1985). Although outbreaks of disease have been reported from some herds in all states, losses from S. suis are generally regarded to be small. Although several outbreaks have been reported in Queensland, Webster (pers. comm.) believed disease caused by S. suis was rare and occurred less frequently than in southern states. Sharrock (1987) isolated S. suis type 9 from Australian pigs and considered this organism was a major cause of deaths in weaners.

The previous work published on infection of Australian pigs with S. suis has reported, either the presence of clinical disease in pigs, or the isolation of the organism from pathological specimens. Prior to this investigation there have been no reports of the presence and significance of subclinical tonsillar carriers in Australian pigs.

The aim of the work described in this chapter was

1. to determine the prevalence of tonsillar carriers of S. suis types 1 and 2 in pigs in Queensland
2. to ascertain if differences existed between the prevalence of S. suis in New Zealand and Australian pigs
3. to determine if infection was present in specific pathogen free (SPF) herds
4. and to establish if carriers were present in the feral pig population and if the pattern of infection was similar to that of domesticated pigs.

MATERIALS AND METHODS

Abattoir Samples

The palatine tonsils were collected from apparently healthy pigs slaughtered at five meatworks in South-Eastern Queensland. An I.F.A.T. for both S. suis types 1 and 2 was performed on the primary bacterial growth as described earlier. However with these samples, the primary medium incorporated Heart Infusion Agar¹ instead of Columbia Base Agar¹.

The herd, sex and size (porker, baconer or chopper/back-fatter) were recorded for all pigs sampled. Pigs from seven specific pathogen free (SPF) herds were included in this survey. These herds were reported to be free from sarcoptic mange, enzootic pneumonia, swine dysentery and swine brucellosis. Ninety-six feral pigs were also sampled at the meatworks. The exact origin of the feral pigs could not be determined as they were collected from depots spread throughout Queensland. These pigs were transported for slaughter within one week of being trapped. The palatine tonsils of these pigs were handled in a similar manner to those of domesticated pigs.

RESULTS

The pattern of infection with S. suis types 1 and 2 in Australian domesticated non-SPF pigs was virtually identical to that recorded for New Zealand domesticated pigs.

In Tables 9.1 and 9.2 the proportion of palatine tonsils from non-SPF domesticated pigs infected with S. suis types 1 and 2 respectively is recorded. Streptococcus suis type 1 was detected in 56% and S. suis type 2 in 70% of the 369 pigs sampled. There was no significant difference ($p > 0.7$) between the prevalence of infection for male and female pigs for either S. suis types 1 or 2.

¹ GIBCO laboratories, Madison, Wisconsin, U.S.A.

TABLE 9.1

ISOLATION RATE OF S. SUIIS TYPE 1 FROM THE PALATINE TONSILS
OF DOMESTICATED NON-SPF AUSTRALIAN SLAUGHTERED PIGS

| HERD | NUMBER OF PIGS EXAMINED | MALE CARRIERS % | FEMALE CARRIERS % | TOTAL CARRIERS % |
|-------|----------------------------|-----------------------|-------------------------|------------------------|
| 1 | 12 | 43 | 80 | 58 |
| 2 | 12 | 50 | 38 | 42 |
| 3 | 11 | 57 | 50 | 55 |
| 4 | 17 | 50 | 56 | 53 |
| 5 | 27 | 59 | 50 | 56 |
| 6 | 30 | 47 | 55 | 50 |
| 7 | 9 | 60 | 75 | 67 |
| 8 | 6 | 50 | 50 | 50 |
| 9 | 16 | 67 | 60 | 63 |
| 10 | 21 | 62 | 63 | 62 |
| 11 | 27 | 59 | 50 | 56 |
| 12 | 17 | 60 | 57 | 59 |
| 13 | 44 | 58 | 65 | 61 |
| 14 | 12 | 50 | 83 | 67 |
| 15 | 8 | 75 | 25 | 50 |
| 16 | 10 | 50 | 50 | 50 |
| 17 | 14 | 67 | 50 | 57 |
| 18 | 9 | 33 | 50 | 44 |
| 19 | 17 | 45 | 50 | 47 |
| 20 | 5 | - | 60 | 60 |
| 21 | 31 | 52 | 60 | 55 |
| 22 | 8 | 67 | 60 | 63 |
| 23 | 6 | 67 | 67 | 67 |
| TOTAL | 337 | 56 | 57 | 56 |

TABLE 9.2

ISOLATION RATE OF S. SUIIS TYPE 2 FROM THE PALATINE TONSILS
OF DOMESTICATED NON-SPF AUSTRALIAN SLAUGHTERED PIGS

| HERD | NUMBER OF PIGS EXAMINED | MALE CARRIERS % | FEMALE CARRIERS % | TOTAL CARRIERS % |
|-------|----------------------------|-----------------------|-------------------------|------------------------|
| 1 | 12 | 71 | 60 | 67 |
| 2 | 12 | 75 | 63 | 67 |
| 3 | 11 | 71 | 50 | 64 |
| 4 | 17 | 63 | 67 | 65 |
| 5 | 27 | 71 | 60 | 67 |
| 6 | 30 | 63 | 73 | 67 |
| 7 | 9 | 80 | 75 | 78 |
| 8 | 6 | 50 | 100 | 67 |
| 9 | 16 | 50 | 70 | 63 |
| 10 | 21 | 69 | 75 | 71 |
| 11 | 27 | 76 | 70 | 74 |
| 12 | 17 | 90 | 71 | 82 |
| 13 | 12 | 83 | 83 | 83 |
| 14 | 12 | 83 | 83 | 83 |
| 15 | 8 | 50 | 75 | 63 |
| 16 | 10 | 75 | 67 | 70 |
| 17 | 14 | 83 | 63 | 71 |
| 18 | 9 | 67 | 83 | 78 |
| 19 | 17 | 73 | 83 | 76 |
| 20 | 5 | - | 80 | 80 |
| 21 | 31 | 71 | 60 | 68 |
| 22 | 8 | 67 | 80 | 75 |
| 23 | 6 | 33 | 100 | 67 |
| TOTAL | 337 | 75 | 70 | 71 |

In Tables 9.3 and 9.4 the proportion of infected tonsils from pigs originating from SPF herds is recorded for S. suis types 1 and 2 respectively. Streptococcus suis types 1 and 2 were not detected in three of the seven herds examined. In the herds found to be infected 52% were infected with S. suis type 1 and 72% with S. suis type 2. As with non-SPF domesticated pigs, there was no significant difference ($p > 0.5$) between the prevalence of infection for male and female pigs for either S. suis types 1 or 2.

In Table 9.5 a comparison is shown between Australian non-SPF domesticated pigs, infected SPF pigs, non-infected SPF pigs, feral pigs and the New Zealand domesticated pigs is seen for S. suis types 1 and 2. In the case of feral pigs, 63% were infected with S. suis type 2 whilst only 18% were identified as tonsillar carriers of S. suis type 1. As with other pigs there was no significant difference ($p > 0.7$) between the prevalence of infection with S. suis types 1 or 2 for male and female pigs. In infected herds there was no significant difference ($p > 0.1$) between the number of carriers of S. suis type 2 in Australian domesticated pigs, infected SPF pigs, feral pigs and New Zealand pigs. There was however a significant difference ($p < 0.0001$) between the non-infected SPF herds and all other herds for S. suis type 2. There was also no significant difference ($p > 0.2$) between the number of non-SPF domesticated pigs, infected SPF pigs, and New Zealand pigs infected with S. suis type 1. However there was a significant difference ($p < 0.0001$) between the number of feral pigs and the number of non-SPF domesticated pigs infected with S. suis type 1.

Table 9.6 records the different percentages of tonsils infected with S. suis types 1 and 2 in porkers, baconers and choppers. For both S. suis types 1 and 2 baconers had the highest rate of infection (58% for S. suis type 1 and 71% for S. suis type 2). The percentage of tonsils of porkers infected with S. suis types 1 and 2 was 54% and 70% respectively, and in choppers it was 47% and 67%. However these differences were not significant ($p > 0.6$).

TABLE 9.3

ISOLATION RATE OF S. SUIIS TYPE 1 FROM THE PALATINE TONSILS
OF SPF SLAUGHTERED PIGS

| HERD | NUMBER OF PIGS EXAMINED | MALE CARRIERS % | FEMALE CARRIERS % | TOTAL CARRIERS % |
|------|----------------------------|-----------------------|-------------------------|------------------------|
| 1 | 25 | 0 | 0 | 0 |
| 2 | 14 | 67 | 63 | 64 |
| 3 | 57 | 50 | 57 | 53 |
| 4 | 31 | 0 | 0 | 0 |
| 5 | 36 | 0 | 0 | 0 |
| 6 | 32 | 47 | 53 | 50 |
| 7 | 68 | 48 | 51 | 50 |

TABLE 9.4

ISOLATION RATE OF S. SUIIS TYPE 2 FROM THE PALATINE TONSILS
OF SPF SLAUGHTERED PIGS

| HERD | NUMBER OF PIGS EXAMINED | MALE CARRIERS % | FEMALE CARRIERS % | TOTAL CARRIERS % |
|------|----------------------------|-----------------------|-------------------------|------------------------|
| 1 | 25 | 0 | 0 | 0 |
| 2 | 14 | 67 | 75 | 71 |
| 3 | 57 | 75 | 67 | 72 |
| 4 | 31 | 0 | 0 | 0 |
| 5 | 36 | 0 | 0 | 0 |
| 6 | 32 | 67 | 76 | 72 |
| 7 | 68 | 67 | 77 | 72 |

TABLE 9.5

THE PREVALENCE OF INFECTION WITH S. SUIIS IN PIGS OF DIFFERENT ORIGIN

| ORIGIN OF PIGS | <u>S. SUIIS</u> TYPE 1 | | <u>S. SUIIS</u> TYPE 2 | |
|---|------------------------|----------------------------|------------------------|----------------------------|
| | NUMBER EXAMINED | INFECTED TONSILS (%) | NUMBER EXAMINED | INFECTED TONSILS (%) |
| Australian Non-SPF Domesticated | 369 | 56 | 369 | 70 |
| Australian SPF Herds Infected | 171 | 52 | 171 | 72 |
| Australian SPF Herds Non-Infected | 92 | 0 | 92 | 0 |
| Australian Feral | 96 | 18 | 96 | 63 |
| New Zealand Non-SPF Domesticated | 365 | 51 | 590 | 75 |

TABLE 9.6

AGE (CLASS) SPECIFIC RATES OF INFECTION WITH S. SUIIS IN THE
PALATINE TONSILS OF SLAUGHTERED PIGS

| CLASS OF PIG | NUMBER EXAMINED | <u>S. SUIIS</u> TYPE 1 | <u>S. SUIIS</u> TYPE 2 |
|--------------------------|--------------------|--------------------------------------|--------------------------------------|
| | | NUMBER OF INFECTED TONSILS (%) | NUMBER OF INFECTED TONSILS (%) |
| Porkers | 63 | 34 (54) | 44 (70) |
| Baconers | 291 | 168 (58) | 206 (71) |
| Choppers- Backfatters | 15 | 7 (47) | 10 (67) |

DISCUSSION

In this survey of Australian pigs, as with the one reported for New Zealand pigs in Chapter V, it would appear that all non-SPF pigs are infected with both S. suis types 1 and 2. The reasons for this could be explained by the similar high density of pigs, the rapid spread of infection and the long duration of carriage as discussed earlier.

In non-SPF Australian domesticated pigs, 57% were identified as infected with S. suis type 1 and 70% with S. suis type 2, compared with 51% and 75% for New Zealand pigs. These differences are not significant ($p > 0.1$). Similarly there were no detected differences between pigs of different size or of either sex. These findings would indicate that the pattern and method of spread of infection is probably similar in New Zealand and Australia. Because of the worldwide distribution of infection with S. suis (Robertson, 1985b) it is also highly probable that the pattern of infection is the same throughout the world.

Of the seven SPF herds sampled only four were found to be infected with S. suis types 1 and 2, with the remaining herds free of infection from both organisms. The probability that these latter herds were infected is less than 1 in 3×10^{10} for S. suis type 1 (based on a sensitivity of 62%) and less than 1 in 3×10^{15} for S. suis type 2 (based on a sensitivity of 76%). Because of these extremely small probabilities, it is highly likely that these SPF herds were indeed free from infection. In Chapters V and VI it was proposed that in utero infection was responsible for subsequent early infection of piglets with S. suis. Group B streptococci, as discussed earlier, have many similarities with S. suis. An important syndrome produced by group B streptococci is that of neonatal sepsis. Investigation into the epidemiology of this disease has revealed that maternal uterine infection with group B streptococci plays an important role in the subsequent neonatal infection (Eickhoff et al, 1964; Baker and Barrett, 1973; 1974). These workers proposed that infection of the neonate occurred during passage through the caudal reproductive tract. Delivery by caesarian section overcomes this problem by avoiding the contact of the neonate with the infected vagina. Similarly hysterectomy derived piglets could overcome exposure and subsequent

infection with S. suis by the fact that they are removed prior to passage through the vagina. In natural farrowings, the movement of the piglet through an infected vagina and uterus is presumably sufficient to allow infection to occur. As the majority of piglets are born without placental coverage, there is normally contact between the piglet and the reproductive tract.

The presence of infection in four SPF herds is presumably due to breakdown of the "barrier". These herds were however free from enzootic pneumonia, mange, swine dysentery and swine brucellosis. In Chapter IV it was shown that S. suis could be isolated from the environment of a piggery with up to 10% of swabs collected from the floors and feed troughs being positive for S. suis. Due to this high level of environmental contamination it is possible that S. suis was introduced to previously free herds by contaminated goods or personnel. The SPF herds sampled in this survey were initially stocked with hysterectomy derived pigs or from the progeny of hysterectomy derived pigs. All subsequent introductions were from other SPF herds, by pigs produced from further hysterectomies or by artificial insemination. No clinical disease, typical of that caused by S. suis, had been recognized in the SPF herds. However clinical disease had not been seen in the majority of the non-SPF domesticated herds. These findings would support those recorded from herds of New Zealand pigs, where it would appear that clinical disease is rare even though S. suis is endemic at a level approaching 100%.

From the examination of feral pigs, it would also appear that infection with S. suis type 2 is endemic at a level approaching 100%. The present findings are supported by the serological results reported in Chapter V for feral pigs from New Zealand. However, there was a significant difference ($p < 0.0001$) between the number of feral pigs infected with S. suis type 1 and the number of domesticated pigs infected with this type. This also supports the findings presented earlier where the titres to S. suis type 1 in New Zealand feral pigs were lower and had a greater range than titres from New Zealand domesticated pigs. The present findings add further support to the hypothesis that maintenance of infection with S. suis type 1 is determined by the population density of pigs. Feral pigs in Australia can be found in small groups of one to ten or occasionally in large mobs of up to one hundred pigs. As the exact origin of the feral pigs

sampled in this survey could not be ascertained, it must be presumed that representatives of both groups were sampled. Pigs in large mobs may have sufficient contact with other pigs to maintain a cycle of infection and reinfection. In smaller groups this contact with a "shedding" pig is reduced or absent and therefore the prevalence of infection would be lower. In the present investigation, the finding that some pigs were infected with S. suis type 1 would support the hypothesis that some pigs from large groups were sampled.

CONCLUSIONS

1. Streptococcus suis type 1 was detected in 56% and S. suis type 2 in 70% of Australian domesticated pigs. The similarity of these values to those obtained from New Zealand pigs would indicate a similar pattern of infection in both countries.
2. As some SPF herds were detected as being free from infection with S. suis, it is probable that hysterectomy derived piglets are free from infection. This is analogous to infection of human neonates with group B streptococci from the reproductive tract of the mother at the time of birth.
3. Detection of S. suis in some SPF herds is probably associated with a prior breakdown of the barrier allowing the entry of S. suis.
4. Similar prevalence rates of infection with S. suis type 2 were recorded in both domestic and feral pigs, indicating a similar pattern of infection in both types of pig.
5. There were fewer feral pigs infected with S. suis type 1 than domesticated pigs. This would indicate that the pattern of infection is different in feral and domesticated pigs for S. suis type 1.
6. The difference in pattern of infection by S. suis types 1 and 2 in feral pigs indicates differences in the epidemiological features of infection by these two organisms. These differences could be explained by the hypothesis that infection with S. suis type 1 is dependent on a series of reinfections and is related to the population density of pigs.

CHAPTER X

GENERAL DISCUSSION

Infections by S. suis types 1 and 2 have been recognized in most pig rearing countries, however the organisms have only recently been identified in pigs in New Zealand (Robertson, 1985). The initial isolation of these organisms stimulated the work described in this thesis. From this work it appeared that the pattern of infection was different to that reported in other countries.

In many studies, the reported prevalence of infection in pigs with S. suis in the palatine tonsils has varied from 0 to 100%. However most studies have recorded a prevalence rate of less than 20%. In the present investigation, over 70% of pigs were recognized as being infected with S. suis type 2 and over 50% with S. suis type 1. Previous workers have relied on traditional microbiological techniques, which employed the use of cultural, biochemical and serological tests, to identify pigs infected with S. suis. In the present study, these tests were found to be of low sensitivity which may account for the wide variation in the prevalence reported by other workers. As the accuracy of the tests used by previous workers was not determined, the validity of their findings may be questionable. In the present investigation an I.F.A.T. was developed which appears to be of high sensitivity and specificity, is easy to use and is quicker than the traditional microbiological techniques. Based on the rapid spread of infection to and between young pigs and the long duration of infection, it was proposed that 100% of post-weaning pigs are infected with S. suis. Further epidemiological studies tended to confirm this hypothesis. The high prevalence of infection in New Zealand and Australian pigs and the presence of these organisms in pigs from the major pig rearing countries, suggests that S. suis is endemic at a similar level in pigs in all other countries.

In the present study, only antisera to S. suis types 1 and 2 were available. However it is highly probable that the other types of S. suis recognized by Perch et al (1983) and Boetner et al (1987) are

also present in pigs in New Zealand and Australia. Many organisms that were biochemically similar, yet serological distinct, to S. suis types 1 and 2 were isolated from the palatine tonsils. Based on the findings relating to S. suis types 1 and 2, it is also probable that these other types of S. suis are endemic in a high proportion of Australian and New Zealand pigs.

Although the I.F.A.T. can detect specific types of S. suis, depending upon the antisera used, this test cannot differentiate between pathogenic and non-pathogenic strains. Although 100% of pigs are considered to be infected with S. suis, it cannot be inferred that all pigs are infected with pathogenic strains. However, if the transmission between pigs and the duration of infection is similar for the potentially pathogenic and the non-pathogenic strains, then it is likely that both will be present in all pigs within herds exposed to infection.

Streptococcus suis is apparently an ubiquitous organism specifically adapted to pigs. Other groups of streptococci appear to have evolved and adapted to different specific species of animals, for example group G streptococci predominantly affect dogs and foxes and groups E and P also affect pigs. However, other streptococci such as group D enterococci show little host specificity and are found in most animal species. Streptococcus suis (Lancefield groups R and S) show several characteristics of specific adaptation to pigs. This is evident by the low pathogenicity of most isolates, the high prevalence of infection and the rapid transmission of the organism from animal to animal and from generation to generation. Although S. suis can be found in all pigs, it is obvious that there are strain differences. In the present investigation, a human isolate was found to be more pathogenic for pigs and laboratory animals than were porcine isolates. The reasons for such a strain difference are unknown. The pathogenic strains may arise by genetic transformations similar to those responsible for the development of antibiotic resistance reported in group A streptococci (Dobrzanski, 1972) or they may be innately different.

If different isolates of S. suis type 2 have different degrees of pathogenicity for both pigs and laboratory animals, it is likely that they would have similar differences in pathogenicity for humans.

Bacterial restriction endonuclease DNA analysis (BRENDA) performed on isolates of S. suis type 2 from the palatine tonsils of apparently normal pigs showed that at least three patterns were present. Only one pattern could be identified in the isolates of S. suis type 1. Unfortunately facilities were not available for examining the BRENDA pattern of the human strain. It is possible that organisms with different BRENDA patterns may be also of different pathogenicity. This area would be worthy of further research. Mice could be used as an indicator species for determining the pathogenicity of isolates of S. suis type 2 as, in the present investigation, isolates pathogenic for humans and pigs were also pathogenic for mice. Among the advantages of using mice for such studies are their cheapness and ease of handling and housing. Rabbits are not suitable for pathogenicity trials as they appear to be equally susceptible to strains of S. suis which are both pathogenic and non-pathogenic for pigs and humans.

Although S. suis may be endemic in all pigs of the world, the losses suffered due to infection with these organisms vary from country to country. In Europe and in particular Great Britain, disease from S. suis type 2 constitutes one of the major post-weaning problems. In these countries the predominant signs are meningitis, septicaemia and arthritis. In the United States of America and Canada, disease from S. suis type 2 is associated with bronchopneumonia, and lower rates of mortality than those reported in Europe. In Australia the losses reported from S. suis type 2 vary from state to state. However it is not considered to be a cause of serious post-weaning loss. In New Zealand the disease is rare and this may account for the delay in recognizing the presence of the organism in this country. In the period from 1985 to mid 1987, 46 pigs from two herds of 60 and 180 sows (Herds 1 and 2 from Chapter V), were autopsied at the Department of Veterinary Pathology and Public Health, Massey University. Of these pigs, only three (6%) were considered to have died as a result of infection from S. suis. One had an infection with S. suis type 2 and two with S. suis type 1. Although S. suis can be regularly isolated from the blood and brains of apparently normal pigs, the organism rarely appears to produce clinical disease in Australian and New Zealand pigs. These differences in the clinical picture between countries are probably associated with the presence of different strains of organisms. In New Zealand and Australia, most strains appear to have a low pathogenicity, whilst in Britain more pathogenic

strains probably exist. It is possible that in the future more pathogenic strains could evolve in New Zealand and Australia with a subsequent increase in the losses caused by this organism. The reverse situation appears to be occurring in relation to S. suis type 1 in Europe. In the 1950's and 1960's, meningo-encephalitis of piglets caused by S. suis type 1 was a common problem in piggeries (Field et al, 1954). However, the disease is now rarely seen (Elliot et al, 1980). Although this change in morbidity may be associated with changes in the management and handling of pigs, it could also have been caused by genetic drift to less pathogenic forms.

Although imported pigs are rigorously tested for the presence of infections of exotic disease, less thorough examinations are undertaken for organisms already endemic in the importing country. Therefore the importation of live animals may allow for the introduction of more pathogenic strains of S. suis into New Zealand and Australia. As S. suis could not be detected in any of the male reproductive tissues sampled in this survey other than one seminal vesicle, it would appear that semen is likely to be free of S. suis. The introduction of new genetic material would therefore be safer by the importation of frozen semen rather than with the importation of live pigs.

The prevalence of infection is proportional to the product of the incidence and the duration of infection, and in stable diseases the prevalence equals the product of the incidence and duration (MacMahon and Pugh, 1970). Therefore, if the prevalence of infection is 100% and the duration is infinite (as long as the pig survives) the annual incidence must be small. This is graphically demonstrated for a fixed number of pigs in Figure 10.1. In this figure, the weekly incidence and prevalence rates are determined from the work described in Chapter VII. In the first week of life the prevalence and incidence rates are comparable. After this time, the prevalence increased to 100% for both S. suis types 1 and 2, whilst the incidence increased slightly for S. suis type 1 to 40% and then dropped to 0% when the pigs were seven weeks old. For S. suis type 2, the incidence fell after the first week to be 0% at the age of five weeks. The reduction in incidence is associated with a decrease in the number of pigs susceptible to infection (previously non-infected pigs). This figure shows that over 50% of pigs are infected with S. suis type 2 in the first week of

life, whilst it takes nearly two weeks for over half of the pigs to become infected with S. suis type 1. For most of the life of a group of pigs the incidence of infection would be nil and the prevalence 100%. However in a breeding herd there are always some sows farrowing and producing non-infected piglets which are subsequently infected. Based on an assumed production of 2.2 litters/sow/year, ten piglets a litter and the slaughter of baconers at 22 weeks, at any one time in a breeding herd, 91.8% of pigs would be infected with S. suis type 1 and 94.8% with S. suis type 2. A weekly incidence of approximately 4.5% and 5.8% for S. suis types 1 and 2 respectively would be seen in each herd. This is based on the assumption that all pigs are infected with S. suis type 1 by the age of 14 days and S. suis type 2 by nine days.

In the present investigation, S. suis type 2 was detected in a greater percentage of palatine tonsils and nasal swabs than was S. suis type 1. This was believed to have been associated with the sensitivity of the I.F.A.T. It was proposed that fewer organisms of S. suis type 1 were present in the tonsils and therefore there was a smaller probability of detecting one in a tonsillar swab. This was supported by the findings in Chapter VI, when the cohort of piglets were all infected with S. suis type 2 (26 days) earlier than with S. suis type 1 (38 days). These results were in contrast to the typical clinical picture, where disease from S. suis type 1 occurs predominantly in sucking piglets, whilst disease from S. suis type 2 occurs in weaners and growers. The antibody response in domestic pigs followed a similar pattern for both organisms. Compared with the antibody level to S. suis type 1, antibody to S. suis type 2 increased later, after reaching a low point corresponding with the reduction of maternal antibody. This slower increase in antibody to S. suis type 2 may account for the more frequent sign of disease in the post-weaning phase, or alternatively higher levels of antibody may be needed to protect against infection with S. suis type 2 than with S. suis type 1.

When feral pigs were compared with domesticated pigs a significantly different prevalence and level of antibody to S. suis type 1 were found. In feral pigs, the geometric mean titres for S. suis type 1 were lower than those for S. suis type 2, whilst in domesticated pigs the geometric mean titres were comparable. Also for

both feral and domesticated pigs, the range of titres for S. suis type 1 was greater than that for S. suis type 2. This pattern could be explained if the assumption that S. suis type 1 was carried for life was incorrect. If a series of reinfections occurred, the prevalence of S. suis type 1 would be dependent on the population density as discussed in Chapter VI and IX. The high population density of domesticated pigs, would allow the continuous spread of infection from infected to non-infected pigs and consequently a higher prevalence and the development of higher titres. With the smaller population density of feral pigs, there would be less chance of reinfections occurring and therefore a lower prevalence of infection and lower titres than in domesticated pigs. Similarly, small herds of domesticated pigs may also be expected to have a lower prevalence than larger herds. From the results of the cross-sectional survey reported in Chapter V, there was no significant difference ($p > 0.3$) between the number of pigs infected with S. suis type 1 from herds with more than five sows, and the number of infected pigs from herds with less than five breeding animals. However, there was a higher prevalence in the larger herds (51%) compared with the smaller herds (46%). If feral pigs lived in a "mob", then a higher prevalence of infection and therefore higher titres to S. suis type 1 could be anticipated than if they remained in small groups or in isolation. In New Zealand, where feral pigs are predominantly found in the forested areas, most pigs live in isolation or congregate in small groups of less than five pigs, whilst in Australia large numbers of feral pigs can be found in the open grain growing areas. Therefore, it would be expected that the prevalence of S. suis type 1 would be greater in Australian feral pigs than in New Zealand feral pigs. The similar management practices in intensive piggeries in New Zealand and Australia, would explain the prevalence of infection approaching 100% for both S. suis types 1 and 2 in both countries.

Although S. suis can be isolated from the environment of a piggery, it would appear that carrier pigs are more important for the spread and transmission of the organism than a contaminated environment. However, if the organism remains infective in the environment, this provides another possible route for the infection of pigs. This may be important for the maintenance of S. suis type 1 within a population. This environmental shedding and possible reinfection may account for the detection of S. suis type 1 in the

palatine tonsil of a single pig which had been the sole pig on a farm for four months (Chapter V). Such environmental survival would also place serious doubts on the value of destocking pigs from a piggery in an attempt to eradicate infection. From the work recorded in this thesis, it would appear that pigs should be removed from a piggery for at least one month before the environment could be confidently assumed to be free of S. suis. However, if there is a reduction in the pathogenicity of isolates of S. suis related to their duration in an inanimate environment, as has been reported with group A streptococci of humans, the period of destocking might be shorter than one month. Although surviving organisms might become less pathogenic they would not necessarily become less infective.

Streptococcus suis was found to be capable of surviving under a wide range of laboratory conditions. Associated with this innate resistance and the further protective effects of faeces and dirt, it would be difficult to rapidly and totally remove this organism from a destocked piggery. The use of disinfectants or steam cleaners does not appear warranted for the specific removal of S. suis and would only be of value if used to remove other material or organisms although the presence of faeces or dirt severely limits the effectiveness of these procedures. Water would appear to be an effective diluting agent and therefore hosing out of pens may be one of the cheapest and most efficient methods of reducing environmental contamination of S. suis.

The detection of S. suis in the uterus and vagina of pigs also has important epidemiological implications. In the present work, it was shown that the piglets of sows with vaginas harbouring S. suis type 2 were infected earlier than were piglets from sows without vaginal infection. It is probable that the piglets from vaginal carriers were infected during delivery. This hypothesis is supported by the finding that three of seven piggeries which were stocked with hysterectomy derived pigs were free from infection. In the other four herds it is presumed that S. suis was subsequently introduced into these herds probably by contaminated vehicles or personnel. Although it would appear that closed herds with hysterectomy derived stock can remain free from S. suis, the economic losses from this disease in New Zealand and Queensland would not warrant the cost of destocking and subsequent restocking on the basis of this disease alone.

Although the tonsil appears to be the major site for carriage of S. suis, the organisms have been isolated from many other tissues and fluids. In the present study, S. suis type 2 was isolated from the blood of 3% of apparently normal pigs slaughtered at a meatworks. These findings support the work of Clifton-Hadley and Alexander (1981) who also detected bacteraemia in healthy pigs. The presence of organisms in the blood will lead to the dispersion of these organisms to all body tissues. Therefore if a test of high sensitivity is used, S. suis should be isolated from most body tissues of a normal pig with bacteraemia. In the present study, S. suis could be detected in the liver, pneumonic lung, uteri, seminal vesicles, vaginas and joints of apparently normal pigs which were slaughtered. No organisms were ever demonstrated in normal lung tissue, testes, epididymides, cervixes or muscle tissue. These results may not indicate a true absence of organisms in these tissues, but may rather be a reflection of the amount of blood present in them after slaughter. The assumption that the isolation of S. suis from "diseased" tissues indicates that it is the primary pathogen is repudiated by the finding of this organism in normal tissue. The presence of S. suis in these tissues may be purely coincidental and therefore care should be taken in the interpretation of microbiological results which record the isolation of S. suis. It is obvious that S. suis can cause primary disease, as was evident in the present investigation when the pigs infected with a human isolate of S. suis type 2 developed clinical disease. However, S. suis would also appear to be present frequently as a commensal in the pig. Streptococcus suis may be more of an opportunist, invading tissues after initial damage or infection has occurred. Thus the organism may produce secondary infection in the lung after initial damage by Mycoplasma hyopneumoniae. There also appears to be differences in the capabilities of strains of S. suis to invade damaged tissue. In North America, most isolates of S. suis type 2 have been cultured from lungs from pigs with enzootic pneumonia, but this is not reported from other countries. The ability of S. suis type 2 to act as a pathogenic secondary invader has important implications in relation to the control of the disease. If the primary insult can be eliminated, reduced or controlled, it would follow that the level of disease "caused" by S. suis type 2 would also be reduced. The failure to control the primary problem may account for the poor success rate of treating animals infected with this organism as reported by Windsor (1977). Perhaps more emphasis should be placed on investigating the

primary insult rather than on the secondary invasion of S. suis type 2.

In the present investigation, S. suis type 2 was also isolated from the brains of apparently normal pigs. Therefore the isolation of S. suis type 2 from the brains of pigs with neurological disturbances should also be treated cautiously. It is possible that some other underlying pathological cause such as infection with enterovirus may be responsible for producing the clinical signs. The presence of S. suis type 2 in a "diseased" brain may be a confounding variable or it may be there as a result of secondary invasion after initial damage by other organisms. This may account for the results of Hommez *et al* (1984) who isolated herpes virus (the aetiological agent of pseudorabies or Aujeszky's disease) from the brains of 13% of pigs from which S. suis type 2 was isolated.

As discussed in Chapter VIII, the high level of infection in apparently normal pigs may constitute an important health risk for meat-workers. However, it would appear that strains pathogenic for man are either rare, or primary factors, similar to those discussed for pigs, are needed for the development of disease. The actual risk of infection with S. suis type 2 in healthy meat-workers and pig-farmers would appear to be very small. The risk to house wives would be even smaller and the presence of the organism in meat should in no way interfere with the culinary habits of a population. As many people exposed to pigs had antibody to S. suis type 2 it would appear that infection of humans with S. suis type 2 is not uncommon, yet serious clinical disease appears to be rare. In this respect there are similarities between the disease in pigs and humans. There has been little work on the epidemiology of infections of humans with S. suis type 2, and this is an area requiring further study. Regular collection of sera from a cohort of new meat-workers or pig-farmers would allow the development of antibodies to S. suis type 2 in these occupational groups to be studied. This would enable correlations to be made between any rise in titres and the presence of clinical disease, including mild illnesses which might be attributed to other causes. Similarly any severe clinical cases that develop should be investigated in more detail looking particularly for the presence of other medical conditions in the patients. It is possible that clinical disease is found only in those individuals who are already compromised

due to some other infection, disease, or medical condition. If this is indeed the case then meat-workers and pig-farmers who are diabetics, affected with a debilitating condition or are immunocompromised would be at a far greater risk of clinical disease than their healthy counterparts.

In conclusion, infection and disease of pigs due to S. suis remains an enigmatic condition with very varied clinical signs and economic effects in different parts of the world. Internationally it would appear to be of relatively little public health significance. However from both a microbiological and epidemiological view, it is a fascinating organism about which there are many unanswered questions worthy of further study.

REFERENCES

- Abshire, R. and Guthrie, R.K. (1971)
The use of fluorescent antibody techniques for detection of Streptococcus faecalis as an indicator of faecal pollution of water. Water Research 5: 1089-1097.
- Agarwal, K.K. (1968)
Immunity to streptococcal infection in pigs with special reference to the bactericidal test. Ph.D. dissertation, University of Cambridge. (Abstracted in Veterinary Bulletin (1969), 39: 89).
- Agarwal, K.K. (1969a)
Streptococcus suis infection in young piglets and its control with normal adult pig serum. Indian Journal of Animal Health 8: 107-108. (Abstracted in Veterinary Bulletin (1970), 40: 265)
- Agarwal, K.K. (1969b)
Studies on immunity to streptococcal infections in pigs. Indian Veterinary Journal 46: 542-544.
- Agarwal, K.K., Elliot, S.D. and Lachmann, P.J. (1969)
Streptococcal infection in young pigs. 3. The immunity of adult pigs investigated by the bactericidal test. Journal of Hygiene 67: 491-503.
- Agass, M.J.B., Willoughby, C.P., Bron, A.J., Mitchell, C.J. and Mayon-white, R.T. (1977)
Meningitis and endophthalmitis caused by Streptococcus suis type 2 (group R). British Medical Journal 2: 167-168.
- Alexander, T.J.L., Thornton, K., Boon, G., Lysons, R.J. and Gush, A.F. (1980)
Medicated early weaning to obtain pigs free from pathogens endemic in the herd of origin. Veterinary Record 106: 114-119.
- Ancelle, J.P., Paul, G., Lionsquy, G., Brochard, C., Brassac, R. and Nevot, P. (1977)
[Pork-butcher's meningitis]. Nouvelle Presse Medicale 6: 3749. (Abstracted in Microbiology Abstracts B (1979), 14: 164).
- Anon. (1978a)
Group R streptococcus infections : A new industrial disease?. British Medical Journal 1: 1628.
- Anon. (1978b)
Streptococcal meningitis and pigs. The Lancet 2: 246.
- Anon. (1979a)
Meningitis menace on the increase. Pig Farming June, pp. 73-74.
- Anon. (1979b)
Report of the Veterinary Investigation Service. Veterinary Record 105: 290.
- Anon. (1980)
Streptococcal Meningitis in Pigs. Leaflet 752, Ministry of Agriculture, Fisheries and Food, Tolcarne Drive, Pinner, Middlesex.

- Anon. (1982a)
A.P.I. Analytical Profile Index, A.P.I. System S.A. La Balms les Grottes, Montalieu, Vercieu, France.
- Anon. (1982b)
Meningitis increasing in Canada. Pig News and Information 3: 2.
- Anon. (1983)
Meat and Livestock Commission. Pig Year Book, Milton Keynes, MLC p. 13 (Cited by Guise et al (1985) Veterinary Record 117: 65-66)
- Anon. (1986)
Meningitis. Control and Therapy, June, No. 2163, University of Sydney Postgraduate Committee in Veterinary Science.
- Arends, J.P., Hartwig, N., Rudolph, M., and Zanen, H.C. (1984)
Carrier rate of Streptococcus suis capsular type 2 in palatine tonsils of slaughtered pigs. Journal of Clinical Microbiology 20: 945-947.
- Arends, J.P. and Zanen, H.C. (1985)
A subtype of Streptococcus suis type 2 isolated from cases of meningitis in man and pigs. In Y. Kimura, S. Kotami and Y. Shiokawa (Eds.). Recent Advances in Streptococci and Streptococcal diseases. Proceedings of the 9th Lancefield International Symposium on Streptococci and Streptococcal Diseases. Chertsey U.K. Reedbooks Ltd, pp. 343-344. (Abstracted in Veterinary Bulletin (1986) 56: 447).
- Austrian, R. (1984)
Pneumococcal Infections. In R. Germanier (Ed.) Bacterial Vaccines. Academic Press Inc., Orlando pp 257-288.
- Avril, M.F., Ghanassia, J.P., Leger, J.M., Bure, A. and Modai, J. (1977)
Group R streptococci meningitis. About 2 cases. Medecine et Maladies Infectieuses 7: 531-534. (Abstracted in Microbiology Abstracts B (1978) 13: 161).
- Ayanwale, F.O. (1986)
Emerging zoonoses in Africa 1: Swine encephalitis in man. International Journal of Zoonoses 13: 262-265
- Azuma, R., Hara, F., Oonuma, Y. and Sugimoto, C. (1983)
Streptococcus R (Streptococcus suis type 2) infections in pigs in Japan. National Institute of Animal Health, Quarterly 23: 117-126.
- Bailey, R.W. and Oxford, A.E. (1959)
The nature of the capsular polysaccharides of the dextran-producing organisms Leuconostoc mesenteroides, L. dextranicum and Streptococcus bovis. Journal of General Microbiology 20: 258-266.
- Baker, C.J. and Barrett, A.E. (1973)
Transmission of group B streptococci among parturient women and their neonates. The Journal of Pediatrics 83: 919-925
- Baker, C.J. and Barrett, A.E. (1974)
Group B streptococcal infections in infants. The importance of the various serotypes. Journal of the American Medical Association 230: 1158-1160

- Baker, C.J., Kasper, D.L. and Davis, C.E. (1976)
 Immunochemical characterization of the "native" type 3 polysaccharide of group B Streptococcus. The Journal of Experimental Medicine 143: 258-270.
- Bercea, I.R., Carol-Dumitriu, E., Dobre, I., Nubert, V. and Girbacica, R. (1981)
 [Streptococcus infection in swine. 5. Emergency immunoprophylaxis in foci of streptococcosis]. Lucrari Stiintifice Institutul Agronomic "Nicolae Balcescu", C (Medicina Veterinara) 24: 51-53. (Abstracted in Veterinary Bulletin (1983), 53: 35).
- Bevin, D. (1975)
 Streptococcal meningitis in pigs: immunity to infection assessed by the bactericidal test. Natural Sciences Tripos, Part II, Pathology Dissertation, Department of Pathology, University of Cambridge. (Cited by Clifton-Hadley, F.A. (1984) Veterinary Research Communications 8: 217-227).
- Blackburn, P.W. (1983a)
 Treatment of pigs affected with streptococcal meningitis. The Pig Veterinary Society Proceedings 10: 23-24.
- Blackburn, P.W. (1983b)
 Fluid therapy in pigs. Veterinary Record 112: 332.
- Blackmore, D.K., Bell, L. and Schollum, L. (1979)
 Leptospirosis in meat inspectors : preliminary results of a serological survey. New Zealand Medical Journal 90: 415-418
- Blackmore, D.K. and Harris, R.E. (1987)
Introductory Veterinary Epidemiology. V.P.P.H. Publication No. 10. Faculty of Veterinary Science, Massey University, Palmerston North, New Zealand.
- Blackmore, D.K. and Schollum, L.M. (1982a)
 The occupational hazards of leptospirosis in the meat industry. New Zealand Medical Journal 95: 494-497.
- Blackmore, D.K. and Schollum, L.M. (1982b)
 Risks of contracting leptospirosis on the dairy farm. New Zealand Medical Journal 95: 649-652.
- Blackmore, D.K. and Schollum, L.M. (1982c)
 The serological investigation of occupational exposure to leptospirosis. Third International Symposium on Veterinary Epidemiology and Economics, Arlington, Virginia, United States of America. Veterinary Medicine Publishing Company, Kansas, pp. 544-551.
- Blood, D.C., Henderson, J.A. and Radostits, O.M. (1979)
Veterinary Medicine. A textbook of the diseases of cattle, sheep, pigs and horses, Fifth edition, Bailliere Tindall, London
- Boetner, A.G., Binder, M. and Bille-Hansen, V. (1987)
Streptococcus suis infections in Danish pigs and experimental infection with Streptococcus suis serotype 7. Acta Pathologica et Microbiologica, Scandinavica, Section B 95: In Press.

- Bolton, D.C., Chu, H.J., Ardans, A.A., Kelly, B. and Zee, Y.C. (1981)
Evaluation of the critical parameters of a sensitive ELISA test using purified infectious bovine rhinotracheitis virus antigens. Veterinary Microbiology 6: 265-279.
- Breton, J., Mitchell, W.R. and Rosendal, S. (1986)
Streptococcus suis in slaughter pigs and abattoir workers. Canadian Journal of Veterinary Research 50: 338-341.
- Bridge P.D. and Sneath, P.H.A. (1983)
Numerical taxonomy of streptococcus. Journal of General Microbiology 129: 565-597.
- Brown, L.N. (1969)
Alpha hemolytic streptococci isolated from acute pneumonia and septicaemia of Iowa swine. Proceedings of 73rd Annual Meeting of the United States Animal Health Association. Milwaukee, Wisconsin, pp. 589-595.
- Bryant, J.B. (1945)
Streptococcic septicaemia in swine. Journal of the American Veterinary Medical Association 106: 18-19.
- Buddle, J.R. (1981)
"Sudden death" in pigs : Diagnostic criteria and actions. In Pigs, Proceedings Number 56. The University of Sydney Postgraduate Committee in Veterinary Science, Sydney, Australia pp. 319-341.
- Buddle, J.R. (1985)
Bacterial and Fungal Diseases of Pigs. Animal Health in Australia. Volume 6. Australian Agricultural Health and Quarantine Service. Department of Primary Industries, Australia.
- Buddle, J.R., Jones, J.E.T., Pass, D.A. and Robertson, J. (1981)
The isolation of Streptococcus suis type 2 from a pig with meningitis. Australian Veterinary Journal 57: 437-438.
- Buddle, J.R. and Mercy, A.R. (1981)
"Sudden death" in pigs. In Pigs, Proceedings Number 56. The University of Sydney postgraduate Committee in Veterinary Science, Sydney, Australia, pp. 303-317.
- Bull, C.G. (1914)
A method for estimating the bacteria in the circulating blood in rabbits. Journal of Experimental Medicine 20: 237-248.
- Bull, C.G. (1915a)
The mechanism of the curative action of antipneumococcus serum. Journal of Experimental Medicine 22: 457-465.
- Bull, C.G. (1915b)
A method of serum treatment of pneumococci septicaemia in rabbits. Journal of Experimental Medicine 22: 466-474.
- Bull, C.G. (1915c)
The fate of typhoid bacilli when injected intravenously into normal rabbits. Journal of Experimental Medicine 22: 475-491.
- Bull, C.G. (1916)
Immunity factors in pneumococcus infection in the dog. Journal of Experimental Medicine 24: 7-24.

- Bush, J.A., Jensen, W.N., Cartwright, G.E. and Wintrobe, M.M. (1955)
Blood volume studies in normal and anemic swine. American Journal of Physiology 181: 9-14.
- Buxton, A. and Fraser, G. (1977)
Streptococcus and Pneumococcus. In Animal Microbiology. Vol. 1. Immunology, bacteriology, mycology, diseases of fish and laboratory methods. Blackwell Scientific Publications, Oxford. pp. 165-176.
- Calhoun, M.L. and Brown, E.M. (1975)
Hematology and Hematopoietic Organs. In H.W.Dunne and A.D.Leman (Eds.), Diseases of Swine (4th ed.) Iowa State University Press, Iowa. pp. 38-71.
- Cargill, C.F. (1981)
Piglet mortality and disease. In Pigs, Proceedings Number 56. The University of Sydney Postgraduate Committee in Veterinary Science, Sydney, Australia pp. 59-85.
- Carle, B.N. and Dewhirst, W.M.H. (1942)
A method for bleeding swine. Journal of the American Veterinary Medical Association 101: 495-496.
- Carol-Dumitriu, E. and Bercea, I. (1981)
[Streptococcus infection in swine. 3. Study of Streptococcus suis strains isolated from unweaned piglets]. Lucrari Stiintifice, Institutul Agronomic "Nicolae Balcescu", C (Medicina Veterinara) 24: 41-43. (Abstracted in Veterinary Bulletin (1983), 53: 35).
- Carol-Dumitriu, E., Bercea, I.R., Dobre, I. and Girbacica, R. (1980)
[Streptococcus infection in swine. 1. Correlations between clinical and aetiological aspects of infection in unweaned piglets]. Lucrari Stiintifice Institutul Agronomic "Nicolae Balcescu", C (Medicina Veterinara) 23: 53-57. (Abstracted in Veterinary Bulletin (1982), 52: 708).
- Carol-Dumitriu, E., Bercea, I.R., Dobre, I. and Girbacica, R. (1981a)
[Streptococcus infection in swine. 2. Morphopathological aspects of infections in unweaned piglets]. Lucrari Stiintifice Institutul Agronomic "Nicolae Balcescu", C (Medicina Veterinara) 24: 35-40. (Abstracted in Veterinary Bulletin (1983), 53: 260).
- Carol-Dumitriu, E., Bercea, I.R., Dobre, I. and Girbacica, R. (1981b)
[Streptococcus infection in swine. 4. Carrier state and excretion of pathogens in foci of streptococcosis]. Lucrari Stiintifice, Institutul Agronomic "Nicolae Balcescu", C (Medicina Veterinara) 24: 45-50. (Abstracted in Veterinary Bulletin (1983), 53: 258).
- Carpio, M.M. (1978)
Hemolytic streptococci in supramammary lymph nodes from healthy pigs from the Peruvian jungle. International Journal of Zoonosis 5: 62-64.
- Carrigan, M. (1987)
Streptococcus suis. The Veterinary Pathology Report 15: 9-10.
- Carter, G.R. (1973)
Diagnostic Procedures in Veterinary Microbiology (2nd ed.). C.C.Thomas, Springfield, Illinois, U.S.A.

- Casillo, S. and Blackmore, D.K. (1972)
Uterine infections caused by bacteria and mycoplasma in mice and rats. Journal of Comparative Pathology 82: 477-482.
- Chattopadhyay, B. (1979)
Group R streptococcal infection amongst pig meat handlers - A review. Public Health, London 93: 140-142.
- Chau, P.Y., Huang, C.Y. and Kay, R. (1983)
Streptococcus suis meningitis. An important underdiagnosed disease in Hong Kong. Medical Journal of Australia 1: 414-417.
- Cheng, A.F., Khin-Thi-Oo, Li, E.K. and French, G.L. (1987)
Septic arthritis caused by Streptococcus suis serotype 2. Journal of Infection 14: 237-241.
- Cherry, W.B., Goldman M. and Carski T.R. (1966)
Fluorescent antibody techniques in the diagnosis of communicable diseases. U.S. Department of Health, Education and Welfare, Washington D.C.
- Clausen, H.M. (1980)
In vitro and animal experiments on the occurrence and importance of streptococci of serogroup R in pigs. Inaugural dissertation, Tierärztliche Hochschule, Hannover, p. 95. (Abstracted in Veterinary Bulletin (1981), 51: 622).
- Clements, M.R. and Hamilton, D.V. (1981)
Group R streptococcal infection. British Medical Journal 282: 989.
- Clements, M.R., Hamilton, D.V., Clifton-Hadley, F.A. and O'Reilly, J.F. (1982)
Streptococcus suis type 2 infection. A new industrial disease?. Practitioner 226: 323-325.
- Clifton-Hadley, F.A. (1982)
Streptococcal meningitis. Pig Farming October, pp. 70,75.
- Clifton-Hadley, F.A. (1983a)
Streptococcus suis type 2 infections. British Veterinary Journal 139: 1-5.
- Clifton-Hadley, F.A. (1983b)
Epidemiology of Streptococcus suis type 2 infections. In J.R. Walton, E.G. White and S.A. Hall (Eds.), Some Diseases of Emerging Importance to Community Trade. Commission of the European Communities, Luxembourg, pp. 33-39.
- Clifton-Hadley, F.A. (1984)
Studies of Streptococcus suis type 2 infection in pigs. Veterinary Research Communications 8: 217-227.
- Clifton-Hadley, F.A. (1985)
Epidemiology of Streptococcus suis type 2 infection. In C.S.G. Grusnell, F.W.G. Hill and M.E. Ryan (Eds.), Veterinary Annual (25th issue). John Wright and Sons, Bristol, pp. 161-166.
- Clifton-Hadley, F.A. and Alexander, T.J.L. (1980)
The carrier site and carrier rate of Streptococcus suis type 2 in pigs. Veterinary Record 107: 40-41.

- Clifton-Hadley, F.A. and Alexander, T.J.L. (1981)
Studies of Streptococcus suis type 2 infection. The Pig Veterinary Society Proceedings 8: 8-17.
- Clifton-Hadley, F.A. and Alexander, T.J.L. (1983)
Further studies of Streptococcus suis type 2 infection. The Pig Veterinary Society Proceedings 10: 14-19.
- Clifton-Hadley, F.A. and Alexander, T.J.L. (1984)
Epidemiology of Streptococcus suis type 2. In M. Pensaert, J. Hoorens, Ph. Lampo, P. Bonte, W. Coussement and P. Debouck (Eds.), Proceedings of the Eighth International Pig Veterinary Society. Ghent, Belgium, p. 135.
- Clifton-Hadley, F.A., Alexander, T.J.L. and Enright, M.R. (1985)
Diagnosis of Streptococcus suis type 2 infection in pigs. The Pig Veterinary Society Proceedings 14: 27-34.
- Clifton-Hadley, F.A., Alexander, T.J.L. and Enright, M.R. (1986a)
Monitoring herds for Streptococcus suis type 2: Chance contamination of slaughter pigs. Veterinary Record 118: 274.
- Clifton-Hadley, F.A., Alexander, T.J.L., Enright, M.R. and Guise, J. (1984a)
Monitoring herds for Streptococcus suis type 2 by sampling tonsils of slaughter pigs. Veterinary Record 115: 562-564.
- Clifton-Hadley, F.A., Alexander, T.J.L., Upton, I. and Duffus, W.P.H. (1984b)
Further studies on the subclinical carrier state of Streptococcus suis type 2 in pigs. Veterinary Record 114: 513-518.
- Clifton-Hadley, F.A. and Enright, M.R. (1984)
Factors affecting the survival of Streptococcus suis type 2. Veterinary Record 114: 585-587.
- Clifton-Hadley, F.A., Enright, M.R. and Alexander, T.J.L. (1986b)
Survival of Streptococcus suis type 2 in pig carcasses. Veterinary Record 118: 275.
- Coffey, J.M. (1942)
Hemolytic streptococci of serologic group E. Journal of Bacteriology 43: 773.
- Cole, R.M. and Hahn, J.J. (1962)
Cell wall replication in Streptococcus pyogenes. Science 135: 722-724.
- Coles, E.H. (1974)
Veterinary Clinical Pathology. (2nd ed.) W.B. Saunders Company. Philadelphia.
- Collier, J.R. and Noel, J. (1971a)
Streptococcic lymphadenitis of swine : A contagious disease. American Journal of Veterinary Research 32: 1501-1505.
- Collier, J.R. and Noel, J. (1971b)
Streptococcic lymphadenitis of swine : An immune carrier of Streptococcus suis. American Journal of Veterinary Research 32: 1507-1509.

- Collier, J.R. and Noel, J. (1974)
Streptococcal lymphadenitis of swine: Prolonged carrier state and bacterial dynamics in the induction of disease. American Journal of Veterinary Research 35: 799-801.
- Colman, G. and Ball, L.C. (1984)
Identification of streptococci in a medical laboratory. Journal of Applied Bacteriology 57: 1-14.
- Constable, P.J. and Harrington, J.M. (1982)
Risks of zoonoses in a veterinary service. British Medical Journal 284: 246-248.
- Cotchin, E. and Hayward, A. (1953)
Streptococcal endocarditis in a pig following intravenous injection of an organism from a natural case. Journal of Comparative Pathology 63: 68-72.
- Cowan, S.T. and Steel, K.J. (1974)
Manual for the Identification of Medical Bacteria (2nd ed.). Cambridge University Press.
- Cruickshank, R., Duguid, J.P., Marmion, B.P. and Swain, R.H.A. (1973)
Medical Microbiology (Vol. 1 - Microbial Infections) (12th ed.) Churchill Livingstone, Edinburgh.
- Cruickshank, R., Duguid, J.P., Marmion, B.P. and Swain, R.H.A. (1975)
Medical Microbiology (Vol. 2 - The practice of Medical Microbiology) (12th ed.) Churchill Livingstone, Edinburgh.
- Cutlip, R.C. and Shuman, R.D. (1971)
Susceptibility of rabbits to infection with Lancefield's group E streptococci. Cornell Veterinarian 61: 607-616.
- Daleel, E.E. and Frost, A.J. (1967)
Some observations on the bacterial flora of the bovine tonsils. British Veterinary Journal 123: 232-235.
- Deibel, R.H. (1977)
Enterococci. In A. Von Graevenitz (Ed.), CRC Handbook Series in Clinical Laboratory Science. Section E : Clinical Microbiology (Vol. 1) CRC press, Cleveland, Ohio, pp. 83-85.
- Deibel, R.H., Yao, J., Jacobs, N.J. and Niven, C.F. (1964)
Group E streptococci 1. Physiological characterization of strains isolated from swine cervical abscesses. Journal of Infectious Diseases 114: 327-332.
- De Moor, C.E. (1962a)
Verslagen en Mededeelingen betreffende de Volksgezondheid No 1/2: 129. (Cited by Zanen, H.C. and Engel, H.W.B. (1975) The Lancet 1: 1286-1288).
- De Moor, C.E. (1962b)
Verslagen en Mededeelingen betreffende de Volksgezondheid No 12: 1938. (Cited by Zanen, H.C. and Engel, H.W.B. (1975) The Lancet 1: 1286-1288).
- De Moor, C.E. (1963)
Septicaemic infections in pigs, caused by haemolytic streptococci of new Lancefield groups designated R,S and T. Antonie van Leeuwenhoek, Journal of Microbiology and Serology 29: 272-280.

- Dickie, A.S., Wong, P.Y.N., North, J.D.K. and Robertson, I.D. (1987)
Streptococcus suis bacteraemia. New Zealand Medical Journal In Press.
- Dobrzanski, W.T. (1972)
Transformation among streptococci: Mechanisms and implications. In L.W. Wannamaker and J.M. Madsen (Eds.), Streptococci and streptococcal diseases. Recognition, Understanding and Management. Academic Press, New York. pp. 81-97.
- Douglas, J.T., Naka, S.O. and Lee, J.W. (1984)
Development of an ELISA for detection of antibody in leprosy. International Journal of Leprosy 52: 19-25.
- Douglas, R.G.A. (1983)
Short paper on prevention of streptococcal meningitis. The Pig Veterinary Society Proceedings 10: 20-22.
- Douglas, R.G.A. (1984)
An evaluation of the efficacy of a combination of penicillin, chlortetracycline and sulphadimidine in the prevention of deaths caused by Streptococcus suis type 2. In M. Pensaert, J. Hoorens, Ph. Lampo, P. Bonte, W. Coussement and P. Debouck (Eds.), Proceedings of the Eighth International Pig Veterinary Society. Ghent, Belgium, p. 137.
- Drees, D.T. and Waxler, G.L. (1970)
Enteric colibacillosis in gnotobiotic swine : A fluorescence microscopic study. American Journal of Veterinary Research 31: 1147-1157.
- Dudding, B.A. and Ayoub, E.M. (1968)
Persistence of streptococcal group A antibody in patients with rheumatic valvular disease. Journal of Experimental Medicine 128: 1081-1098.
- Dunne, H.W. (1963)
Field and Laboratory Diagnosis of Hog Cholera. Veterinary Medicine 58: 222-239.
- Eickhoff, T.C., Klein, J.O. and Daly, A.K. (1964)
Neonatal sepsis and other infections due to group B beta haemolytic streptococci. The New England Journal of Medicine 271: 1221-1228
- Elder, B.L., Boraker, D.K. and Fives-Taylor, P.M. (1982)
Whole bacterial cell enzyme-linked immunosorbent assay for Streptococcus sanguis fimbrial antigens. Journal of Clinical Microbiology 16: 141-144.
- Elliot, S.D. (1960)
Type and group polysaccharides of group D streptococci. Journal of Experimental Medicine 111: 621-630.
- Elliot, S.D. (1966)
Streptococcal infection in young pigs. 1. An immunochemical study of the causative agent (PM streptococcus). Journal of Hygiene 64: 205-212.

- Elliot, S.D. (1983)
 Characterization and serological classification of Streptococcus suis. In J.R. Walton, E.G. White and S.A. Hall (Eds.), Some Diseases of Emerging Importance to Community Trade. Commission of the European Communities, Luxembourg, pp. 4-11.
- Elliot, S.D., Alexander, T.J.L. and Thomas, J.H. (1966)
 Streptococcal infection in young pigs. 2. Epidemiology and experimental production of the disease. Journal of Hygiene 64: 213-220.
- Elliot, S.D., Clifton-Hadley, F.A. and Tai, J. (1980)
 Streptococcal infection in young pigs. 5. An immunogenic polysaccharide from Streptococcus suis type 2 with particular reference to vaccination against streptococcal meningitis in pigs. Journal of Hygiene 85: 275-285.
- Elliot, S.D., McCarthy, M. and Lancefield, R.C. (1977)
 Teichoic acids of group D streptococci with special reference to strains from pig meningitis. The Journal of Experimental Medicine 145: 490-499.
- Elliot, S.D. and Tai, J.Y. (1978)
 The type-specific polysaccharides of Streptococcus suis. The Journal of Experimental Medicine 148: 1699-1704.
- Engvall, E. and Perlmann, P. (1971)
 Enzyme-linked immunosorbent assay (ELISA) quantitative assay of immunoglobulin G. Immunochemistry 8: 871-874.
- Erickson, E.D., Doster, A.R. and Pokorny, T.S. (1984)
 Isolation of Streptococcus suis from swine in Nebraska. Journal of the American Veterinary Medical Association 185: 666-668.
- Facklam, R.R. (1980)
 Streptococci and Aerococci. In E.H. Lennette, A. Balows, W.J. Hausler and J.P. Truant (Eds.) Manual of Clinical Microbiology (3rd ed) American Society for Microbiology, Washington D.C., pp. 88-110.
- Farinha, F.B.N., Bersano, J.G., Rodrigues, F.M., Genicolo, L. and Reiter, S.C. (1981)
 [Meningitis caused by Streptococcus type R in swine]. Arquivos do Instituto Biologico, Sao Paulo, Brazil 48: 91-95. (Abstracted in Veterinary Bulletin (1983), 53: 559-560).
- Field, H.I., Buntan, D. and Done, J.T. (1954)
 Studies on piglet mortality 1. Streptococcal meningitis and arthritis. Veterinary Record 66: 453-455.
- Finegold, S.M., Martin, W.J. and Scott, E.G. (1978)
Bailey and Scott's Diagnostic Microbiology, C.V. Mosby Company, Saint Louis.
- Folley, S.J. and Knaggs, G.S. (1966)
 Milk-ejection activity (oxytocin) in the external jugular vein blood of the cow, goat and sow, in relation to the stimulus of milking or suckling. Journal of Endocrinology 34: 197-214.
- Foster, J. (1984)
 Checking the meningitis menace. Pig Farming Jan, p. 78.

- Friend, S.C.E. and Sims, L.D. (1978)
Alpha streptococcal septicaemia and meningitis in weaned pigs. Victorian Veterinary Proceedings 36: 51-52.
- Garrod, L.P., Lambert, H.P. and O'Grady, F. (1973)
Antibiotic and chemotherapy (4th ed.). Churchill-Livingstone, Edinburgh.
- Gotschlich, E.C., Austrian, R., Cvjetanovic, B. and Robbins, J.B. (1978)
Prospects for the prevention of bacterial meningitis with polysaccharide vaccines. Bulletin of the World Health Organization 56: 509-518.
- Guise, H.J., Penny, R.H.C. and Duthrie, A.N.S. (1985a)
Streptococcal meningitis in pigs. Veterinary Record 117: 43-44.
- Guise, H.J., Penny, R.H.C. and Duthrie, A.N.S. (1985b)
Streptococcal meningitis in pigs : Field trial to compare the effects of two different treatments. Veterinary Record 117: 65-66.
- Guise, H.J., Penny, R.H.C. and Petherick, D.J. (1986)
Streptococcal meningitis in pigs: Field trial to study the prophylactic effect of trimethoprim/sulphadiazine medication in feed. Veterinary Record 119: 395-400.
- Hanbury, R.D., Doby, P.B., Miller, H.O. and Murrell, K.D. (1986)
Trichinosis in a herd of swine: Cannibalism as a major mode of transmission. Journal of the American Veterinary and Medical Association 188: 1155-1159.
- Hardie, J.M. (1986)
Genus Streptococcus. In P.H.A. Sneath, N.S. Mair, M.E. Sharpe and J.G. Holt (Eds.) Bergey's Manual of Systematic Bacteriology. Volume 2. (9th ed.) Williams and Wilkins, Baltimore, pp. 1068-1071.
- Hare, T., Fry, R.M. and Orr, A.B. (1942)
First impressions of the beta haemolytic streptococcus infection of swine. Veterinary Record 54: 267-269.
- Hathaway, S.C. and Blackmore, D.K. (1981)
Ecological aspects of the epidemiology of infection with leptospire of the Ballum serogroup in the black rat (Rattus rattus) and the brown rat (Rattus norvegicus) in New Zealand. Journal of Hygiene (Cambridge) 87: 427-436.
- Heard, T. (1984)
Streptococcus suis type 2 in British pig herds. In Practice 6: 69-71.
- Hickling, P. and Cornack, F.C.V. (1976)
Meningitis caused by group R haemolytic streptococci. British Medical Journal 2: 1299-1300.
- Hill, H.R. and Matsen, J.M. (1977)
Streptococci not group A or D. In A. Von Graevenitz (Ed.), CRC Handbook Series in Clinical Laboratory Science. Section E Clinical Microbiology (Vol. 1) CRC press, Cleveland, Ohio, pp. 87-93.

- Ho, H.F. and Blackmore, D.K. (1979)
Effect of chilling and freezing on survival of Leptospira interrogans serovar pomona in naturally infected pig kidneys. New Zealand Veterinary Journal 27: 121-123.
- Hoerlein, A.B., Hubbard, E.D. and Getty, R. (1951)
The procurement and handling of swine blood samples on the farm. Journal of the American Veterinary Medical Association 119: 357-362.
- Hofferber, O. (1952)
[Streptococcal endocarditis in piglets contracted during intra-uterine life]. Monatshefte fur Veterinarmedizin 7: 273-274. (Abstracted in Veterinary Bulletin (1953), 22: 61).
- Holz, K. (1950)
[Streptococcal diseases of swine]. Deutsche Tierarztliche Wochenschrift 57: 165-172. (Abstracted in Veterinary Bulletin (1951), 20: 341).
- Hommez, J., Castryck, F., Devriese, L.A. and Henrichsen, J. (1984)
Prevalence of Streptococcus suis and methods of identification. In M. Pensaert, J. Hoorens, Ph. Lampo, P. Bonte, W. Coussement and P. Debouck (Eds.), Proceedings of the Eighth International Pig Veterinary Society. Ghent, Belgium, p. 134.
- Hommez, J., Devriese, L.A., Henrichsen, J. and Castryck, F. (1986)
Identification and characterization of Streptococcus suis. Veterinary Microbiology 11: 349-355.
- Hont, S. and Banks, A.W. (1944)
Streptococcal endocarditis in young pigs. Australian Veterinary Journal 20: 206-210.
- Hunt, B.W. and Edwards, P.T. (1982)
FAT for Streptococcus suis type 2 infections. Veterinary Record 110: 21.
- Ireland, G. (1986)
Swine disease feed medication. Control and Therapy, Number 2286, postgraduate Committee in Veterinary Science, University of Sydney, Australia.
- Jansen, J. and van Dorssen, C.A. (1951)
[Meningo-encephalitis in pigs caused by streptococci]. Tijdschrift voor Diergeneeskunde 76: 815-832. (Abstracted in Veterinary Bulletin (1953), 23: 181-182).
- Jeppesen, L.E. (1984)
Environment and the behaviour of the sow and her young. The Pig Veterinary Society Proceedings 11: 18-26.
- Jones, J.E.T. (1966)
Observations on parturition in the sow: Part 2: The parturient and post parturient phases. British Veterinary Journal 122: 471-478.
- Jones, J.E.T. (1976a)
The serological classification of streptococci isolated from diseased pigs. British Veterinary Journal 132: 163-170.

- Jones, J.E.T. (1976b)
The carriage of beta-haemolytic streptococci by healthy pigs. British Veterinary Journal 132: 276-283.
- Joynson, D.H.M. (1980)
Infections of man with group R streptococci. British Journal of Clinical Practice 34: 147-149.
- Kawamura, A. (1969)
Fluorescent Antibody Techniques and their Applications.
University of Tokyo Press. Tokyo.
- Kelsey, J.C., Beeby, M.M. and Whitehouse, C.W. (1965)
A capacity use-dilution test for disinfectants. Monthly Bulletin of the Ministry of Health and Public Health Laboratory Service 24: 152-160.
- Kelsey, J.C. and Sykes, G. (1969)
A new test for the assessment of disinfectants with particular reference to their use in hospitals. The Pharmaceutical Journal 202: 607-609.
- Kernkamp, H.C.H. (1941)
Endocarditis in swine due to Erysipelothrix rhusiopathiae and to streptococci. Journal of the American Veterinary Medical Association 98: 132-133.
- Keymer, I.F., Heath, S.E. and Wood, J.G.P. (1983)
Streptococcus suis type 2 infection in a racoon dog (Nyctereutes procyonoides) family Canidae. Veterinary Record 113: 624.
- King, S.J. (1968)
Porcine polyserositis and arthritis - with particular reference to mycoplasmosis and Glasser's disease. Australian Veterinary Journal 44: 227-230.
- Kloppenborg, M., Houwerzijl, J. and Mulder, N.H. (1977)
[Sepsis due to infection with Streptococcus subacidus (type R Lancefield) without signs of meningitis. Nederlands Tijdschrift voor Geneeskunde 121: 1058-1061. (Abstracted in Excerpta Medica, Section 6 Internal Medicine, (1978) 39: 468).
- Kloppenborg, M., Mulder, N.H. and Houwerzijl, J. (1975)
Septicaemia due to porcine streptococci. The Lancet 2: 1218.
- Koehne, G., Maddux, R.L. and Cornell, W.D. (1979)
Lancefield group R streptococci associated with pneumonia in swine. American Journal of Veterinary Research 40: 1640-1641.
- Kohler, W. and Mochmann, H. (1958)
Zentralblatt für Bakteriologie, Parasitenkunde, Infektionskrankheiten und Hygiene 173: 58. (Cited by Williams et al (1973), Research in Veterinary Science 15: 352-362).
- Koldkjaer, O. and Nielsen, G. (1972)
Haemolytic streptococcus group R infection. British Medical Journal 3: 765.
- Koppang N. and Filseth, O. (1958)
Nordisk Veterinaermedicin 10: 603. (Cited by Jones, J.E.T. (1976b) British Veterinary Journal 132: 276-283).

- Kunter, E. (1982a)
Report of Streptococcus Reference Centre concerning streptococci isolated from swine between 1968 and 1980. 1. Serological grouping and pathogenic importance. Archiv fur Experimentelle Veterinarmedizin 36: 279-296.
- Kunter, E. (1982b)
Report by Streptococcus Reference Centre on streptococci isolated from pigs between 1968 and 1980. 2. Sensitivity to chemotherapeutics. Archiv fur Experimentelle Veterinarmedizin 36: 785-799.
- Kunter, E. and Wittig, von W. (1976)
R and S streptococcal infection of pigs. Archiv fur Experimentelle Veterinarmedizin 30: 211-216.
- Lamont, M.H., Edwards, P.T. and Windsor, R.S. (1980)
Streptococcal meningitis in pigs: Results of a five year survey. Veterinary Record 107: 467-469.
- Lamont, M.H., Hunt, B. and Mercer, R. (1984)
Valvular endocarditis associated with Streptococcus suis type 2. Veterinary Record 115: 22.
- Lancefield, R.C. (1933)
A serological differentiation of human and other groups of hemolytic streptococci. The Journal of Experimental Medicine 57: 571-595.
- Lancefield, R.C. (1938)
A micro precipitin-technic for classifying haemolytic streptococci, and improved methods for producing antisera. Proceedings of the Society of Experimental Biology and Medicine 39: 473-476.
- Lancefield, R.C. (1943)
Studies on the antigenic composition of group A hemolytic streptococci 1. Effects of proteolytic enzymes on streptococcal cells. Journal of Experimental Medicine 78: 465-476.
- Lawrie, R.A. (1966)
Meat Science. Pergamon Press, Oxford.
- Lechowich, R.V. (1971)
Microbiology of Meat. In J.F. Price and B.S. Schweigert (Eds.). The Science of Meat and Meat Products. W.H. Freeman and Company, San Francisco.
- Le Menec, M., Kobisch, M. and Sanders, P. (1985)
Streptococcus suis infection in pigs methods of identification and distribution on the serotypes. Recueil de Medecine Veterinaire 161: 353-359.
- Lerner, P.I. (1975)
Meningitis caused by Streptococcus in adults. Journal of Infectious Diseases 131: S9-S16.
- Lerner, P.I., Gopalakrishna, K.V., Wolinsky, E., McHenry, M.C., Tan, J.S. and Rosenthal, M. (1977)
Group B streptococcus (S. agalactiae) bacteraemia in adults: Analysis of 32 cases and review of the literature. Medicine (Baltimore) 56: 457-472.

- Logan, E.F., Meneely, D.J. and Mackie, D.P. (1982)
Enzyme-linked immunosorbent assay for Streptococcus agalactiae antibodies in bovine milk. Veterinary Record 110: 247-249.
- Love, R.J. (1981)
Sudden deaths and septicaemias in weaners and growers. In Pigs, Proceedings Number 56. The University of Sydney Postgraduate Committee in Veterinary Science, Sydney, Australia, pp. 115-120.
- Lu, Y.S., Tsai, H.J., Azuma, R., Sugimoto, C., Lin, D.F. and Lee, Y.L. (1985)
[Streptococcus S and R groups (Streptococcus suis type 1 and type 2) infection in pigs in Taiwan]. Taiwan Journal of Veterinary Medicine and Animal Husbandry 45: 27-33. (Abstracted in Veterinary Bulletin (1986), 56: 185).
- McErlean, B.A. (1956)
Meningo-encephalitis in piglets due to a motile diplococcus. Irish Veterinary Journal 10: 174-175 (Abstracted in Veterinary Bulletin (1957), 27: 55).
- MacFaddin, J.F. (1980)
Biochemical tests for identification of medical bacteria. (2nd ed.) Williams and Wilkins, Baltimore, London.
- Mackenzie, A. (1961)
Observations on anterior vena cava venepuncture in the pig. Veterinary Record 73: 435-436.
- Mackintosh, C.G., Schollum, L.M., Harris, R.E., Blackmore, D.K., Willis, A.F., Cook, N.R. and Stoke, J.C.J. (1980)
Epidemiology of leptospirosis in dairy farm workers in the Manawatu. Part 1: A cross-sectional serological survey and associated occupational factors. New Zealand Veterinary Journal 28: 245-250.
- Mackintosh, C.G., Schollum, L.M., Blackmore, D.K., and Marshall, R.B. (1982)
Epidemiology of leptospirosis in dairy farm workers in the Manawatu. Part 2: A case-control study of high and low risk farms. New Zealand Veterinary Journal 30: 73-76.
- Maclean, C.W. and Thomas, N.D. (1974)
Faecal and vaginal bacteriology of sows during the reproductive cycle. British Veterinary Journal 130: 230-237.
- McLendon, B.F., Bron, A.J. and Mitchell, C.J. (1978)
Streptococcus suis type 2 (group R) as a cause of endophthalmitis. British Journal of Ophthalmology 62: 729-731.
- MacMahon, B. and Pugh, T.F. (1970)
Epidemiology: Principles and Methods. Little, Brown and Company, Boston.
- McNutt S.H. and Packer, R.A. (1943)
A study of some cases of streptococcus infection in swine. Veterinary Student 6: 68. (Cited by R.F. Ross (1972) in L.W. Wannamaker and J.M. Matsen (Eds.), Streptococci and streptococcal diseases. Recognition, Understanding and Management. Academic Press, New York).

- Madec, F., Tillon, J.P., Guilamoto, H. and Le Menec, M. (1985)
[Results of an investigation into sudden death of store pigs caused by streptococci of group R]. Point Veterinaire 17: 433-441 (Abstracted in Veterinary Bulletin (1986), 56: 86).
- Malyavin, A.G. (1956)
[Polyvalent vaccine against paratyphoid, pasteurella and diplococcal infection in piglets, and its use in field trials]. Trudy Gosudarstvennogo nauchno-kontrol nogo instituta veterinarnykh preparatov 6: 266-282. (Abstracted in Veterinary Bulletin (1957), 27: 620).
- Martin, S.W. (1984)
Estimating disease prevalence and the interpretation of screening test results. Preventive Veterinary Medicine 2: 463-472
- Martins, V.M.V., Riet-correa, F., Brito, M.A.V.P., Soncini, R.P., Brito, J.R.F., Piffer, I.P. and Orlandi, J.J. (1985)
[Streptococcal meningitis of swine in Santa Catarina state]. Pesquisa Veterinaria Brasileira 5: 27-35. (Abstracted in Veterinary Bulletin (1986), 56: 87).
- Maxted W.R. and Widdowson, J.P. (1972)
The protein antigens of group A streptococci. In L.W. Wannamaker and J.M. Matsen (Eds.), Streptococci and streptococcal diseases. Recognition, Understanding and Management. Academic Press, New York. pp. 251-266.
- Medrek, T.F. and Barnes, E.M. (1962)
The influence of the growth medium on the demonstration of a group D antigen in faecal streptococci. Journal of General Microbiology 28: 701-709.
- Mogabgab, W.J. and Thomas, L. (1952)
The effects of cortisone on bacterial infection. Group A haemolytic streptococcal infection in rabbits. Journal of Laboratory and Clinical Medicine 39: 271-289.
- Moody, M.D. (1972)
Old and new techniques for rapid identification of group A streptococci. In L.W. Wannamaker and J.M. Matsen (Eds.), Streptococci and streptococcal diseases. Recognition, Understanding and Management. Academic Press, New York, pp. 177-188.
- Moody, M.D., Ellis, E.C. and Updyke, E.L. (1958)
Staining bacterial smears with fluorescent antibody. 4. Grouping streptococci with fluorescent antibody. Journal of Bacteriology 75: 553-560.
- Moody, M.D., Siegel, A.C., Pittman, B. and Winter, C.C. (1963)
Fluorescent-antibody identification of group A streptococci from throat swabs. American Journal of Public Health 53: 1083-1092.
- Muirhead, M.R. (1987a)
Respiratory Diseases. In Pig Production, Proceedings No. 95, The University of Sydney Post-Graduate Committee in Veterinary Science, pp. 561-604.

- Muirhead, M.R. (1987b)
Weaners. In Pig Production, Proceedings No. 95, The University of Sydney Post-Graduate Committee in Veterinary Science, pp. 713-736.
- Narucka, V. and Westendorp, J.F. (1973)
Endocarditis in slaughter pigs. Tijdschrift voor Diergeneeskunde 98: 655-661. (Abstracted in Veterinary Bulletin (1973), 43: 599-600).
- Nesvadba, J., Gilka, F. and Salajka, E. (1960)
[Infectious streptococcal meningitis in piglets]. Sbornik Ceskoslovenske akademie zemedelskych vedeckych, veterinarni medicina 5: 549-554. (Abstracted in Veterinary Bulletin (1960), 30: 668).
- Nielsen, N.C., Bille, N., Larsen, J.L. and Svendsen, J. (1975)
Prewaning mortality in pigs. 7. Polyarthrititis. Nordisk Veterinaermedicin 27: 529-543.
- Owen, J.R. (1982)
The influence of buildings on respiratory disease. The Pig Veterinary Society Proceedings 9: 24-35.
- Parker, M.T. (1978)
In F.A. Skinner and M.R. Quesnel (Eds.), Streptococci. Academic Press, London, p. 71. (Cited by Clifton-Hadley, F.A. and Enright, M.R., (1984) Veterinary Record 114: 584).
- Paul, G., Ancelle, J.P., Lionsquy, G., Brochard, C., Brassac, R. and Nevot, P. (1977)
Human meningitis caused by group R streptococci : A misappreciated anthropozoonosis. Medecine et Maladies Infectieuses 7: 525-529. (Cited in Microbiology Abstracts B (1978), 13: 160-161).
- Pavlova, M.T., Beauvais, E., Brezenski, F.T. and Litsky, W. (1972)
Fluorescent-antibody techniques for the identification group D streptococci : Direct staining method. Applied Microbiology 23: 571-577.
- Payne, J.M. and Deans Rankin, J. (1961a)
The pathogenesis of experimental Johne's disease in calves. Research in Veterinary Science 2: 167-174.
- Payne, J.M. and Deans Rankin, J. (1961b)
A comparison of the pathogenesis of experimental Johne's disease in calves and cows. Research in Veterinary Science 2: 175-179.
- Payne, J.M. and Derbyshire, J.B. (1963)
Portals of entry for bacterial infection in calves and piglets with particular reference to the tonsil. Journal of Pathology and Bacteriology 85: 171-178.
- Pedersen, K.B. (1983)
Streptococcal meningitis in pigs. Experimental infection, treatment and control. In J.R. Walton, E.G. White and S.A. Hall (Eds.), Some Diseases of Emerging Importance to Community Trade. Commission of the European Communities, Luxembourg, pp. 40-45.

- Pedersen, K.B., Henrichsen, J. and Perch, B. (1984)
The bacteriology of endocarditis in slaughter pigs. Acta Pathologica et Microbiologica, Scandinavica, Section B 92: 237-238.
- Pedersen, K.B., Kjems, E., Perch, B. and Slot, P. (1980)
Infection with RS streptococci in pigs. In N.C. Nielsen, P. Høgh and N. Bille (Eds.), Proceedings of the International Pig Veterinary Proceedings. Reproset, Copenhagen, p. 191.
- Pedersen, K.B., Kjems, E., Perch, B. and Slot, P. (1981)
Infection with RS streptococci in pigs. Acta Pathologica et Microbiologica, Scandinavica, Section B 89: 161-165.
- Pedersen, K.B., Slot, P. and Schou, J. (1977)
[Outbreak of streptococcal meningitis in a Danish herd of swine]. Dansk Veterinær-tidsskrift 60: 812-813. (Abstracted in Veterinary Bulletin (1978), 48: 102).
- Peel, R.N., Helm, W.H. and Lamont, M.H. (1979)
Health hazard to pig workers. Veterinary Record 104: 584-585.
- Pento, J.T. (1974)
Measurement of plasma calcitonin in vivo in the pig using a chronically-implanted catheter for infusion and blood sampling. Journal of Animal Science 39: 885-888.
- Perch, B. and Kjems, E. (1971)
Group R streptococci in man. Acta Pathologica et Microbiologica, Scandinavica, Section B 79: 549-550.
- Perch, B., Kjems, E., Slot, P. and Pedersen, K.B. (1981)
Biochemical and serological properties of R, S and RS streptococci. Acta Pathologica et Microbiologica, Scandinavica, Section B 89: 167-171.
- Perch B., Kristjansen, P. and Skadhauge, K. (1968)
Group R streptococci pathogenic for man. Acta Pathologica et Microbiologica, Scandinavica, Section B 74: 69-76.
- Perch, B., Pedersen, K.B. and Henrichsen, J. (1983)
Serology of capsulated streptococci pathogenic for pigs : Six new serotypes of Streptococcus suis. Journal of Clinical Microbiology 17: 993-996.
- Pilot, I., Buck, C. and Davis, D.J. (1936)
Hemolytic streptococci from tonsils of cow, hog and sheep. Proceedings of the Society of Experimental Biology and Medicine 34: 233-235.
- Popovic, M. and Dujin, T. (1971)
[Streptococcal meningoencephalitis syndrome in pigs]. Veterinarski Glasnik 25: 87-90. (Abstracted in Veterinary Bulletin (1972), 42: 313).
- Porter, P. (1975)
The Immune System. In H.W. Dunne and A.D. Leman (Eds.), Diseases of Swine (4th ed.) Iowa State University Press, Iowa. pp. 122-138.

- Power, S.B. (1978)
Streptococcus suis type 2 infection in pigs. Veterinary Record 102: 215-216.
- Pugsley, A.P. and Evison, L.M. (1974)
 Immunofluorescence identification of faecal streptococci using commercially-available antisera. Water Research 8: 725-728.
- Putten van, G. (1981)
 Using pig behaviour to advantage. The Pig Veterinary Society Proceedings 8: 32-37.
- Quinn, R.W. (1977)
 Group A streptococcus. In A. Von Graevenitz (Ed.), CRC Handbook Series in Clinical Laboratory Science. Section E : Clinical Microbiology. CRC Press, Cleveland, Ohio, pp. 73-81.
- Rauch, H.C. and Rantz, L.A. (1963)
 Immunofluorescent identification of group A streptococci in direct throat smears. Journal of Laboratory and Clinical Medicine 61: 529-536.
- Ray, J.D. (1945)
 Enteritis and mixed infections in swine. Veterinary Medicine 40: 48-54.
- Reis, R., Coelho, A.M.B., Nascimento, D.F.Do, Leite, R.C. and Nogueira, R.H.G. (1980)
 [Swine disease in Minas Gerais State, Brazil. 5. Streptococcal meningoencephalitis in weaned pigs]. Arquivos da Escola de Veterinaria da Universidade Federal de Minas Gerais 32: 375-381 (Abstracted in Veterinary Bulletin (1981), 51: 972).
- Rickert, J., Clausen, H.M., Amsberg, G., Meier, C. and Hahn, G. (1982)
 [Bacteriological investigations on the occurrence of streptococci of serogroup R in clinically healthy pigs]. Praktische Tierarzt 63: 1054-1056. (Abstracted in Veterinary Bulletin (1983), 53: 560).
- Riising, H.J. (1976)
 Streptococcal infections in pigs. 2. Serological and biochemical examinations. Nordisk Veterinaermedicin 28: 80-86.
- Riising, H.J., Nielsen, N.C., Bille, N. and Svendsen, J. (1976)
 Streptococcal infections in sucking pigs. 1. Epidemiological investigation. Nordisk Veterinaermedicin 28: 65-79.
- Ripley, P.H. (1983)
 Vaccines against streptococcal meningitis. The Pig Veterinary Society Proceedings 10: 25-39.
- Ripley, P.H., Windsor, R.S. and Novotny, P. (1980)
 The use of autogenous vaccines to control meningitis in pigs caused by Streptococcus suis type 2. In N.C. Nielsen, P. Hogh and N. Bille (Eds.), Proceedings of the International Pig Veterinary Proceedings, Reproset, Copenhagen, p. 190.
- Roberts, C.E. and Sherris, J.C. (1967)
 Fluorescent antibody staining of group A streptococci : Demonstration and elimination of blocking antibody. Journal of Infectious Diseases 117: 371-378.

- Robertson, I.D. (1985a)
An indirect fluorescent antibody technique for the detection of Streptococcus suis type 2. The New Zealand Journal of Medical Laboratory Technology 39: 171-172.
- Robertson, I.D. (1985b)
The isolation of Streptococcus suis types 1 and 2 from pigs in New Zealand. New Zealand Veterinary Journal 33: 148.
- Robertson, I.D. (1986)
Streptococcus suis type 2—a zoonotic agent in New Zealand. New Zealand Medical Journal 99: 167-168.
- Robertson, I.D. and Blackmore, D.K. (1987)
The detection of pigs carrying Streptococcus suis type 2. New Zealand Veterinary Journal 35: 1-4.
- Robinson, R.A. and Metcalfe, R.V. (1976)
Zoonotic Infections in Veterinarians. New Zealand Veterinary Journal 24: 201-210.
- Rosendal, S., Breton, J., Henrichsen, J., Hilt, L. and Mitchell, W.R. (1986)
Isolation of Streptococcus suis using a selective medium. Canadian Journal of Veterinary Research 50: 537-539.
- Ross, R.F. (1972)
Streptococcal infections in swine. In L.W. Wannamaker and J.M. Matsen (Eds.), Streptococci and streptococcal diseases. Recognition, Understanding and Management. Academic Press, New York, pp. 339-348.
- Ross, R.F. (1981)
Streptococcal diseases. In A.D. Leman, R.D. Glock, W.L. Mengeling, R.H.C. Penny, E. Scholl and B. Straw (Eds.). Diseases of Swine (5th ed.). The Iowa State University Press, Ames, U.S.A. pp. 550-557.
- Rote, N.S., Taylor, N.L., Shigeoka, A.O., Scott, J.R. and Hill, H.R. (1980)
Enzyme-linked immunosorbent assay for group B streptococcal antibodies. Infection and Immunity 27: 118-123.
- Saar, L.I. and Getty, R. (1964)
The interrelationship of the lymph vessel connections of the lymph nodes of the head, neck, and shoulder regions of swine. American Journal of Veterinary Research 25: 618-636.
- Sala, V., Socci, A. and Redaelli, G. (1985)
Isolation of Streptococcus suis type 2 from swine infections. La Clinica Veterinaria 108: 24-30.
- Sanford, S.E. and Tilker, A.M.E. (1982)
Streptococcus suis type 2-associated diseases in swine: Observation of a one year study. Journal of the American Veterinary Medical Association 181: 673-676.
- Schmidt, C.B. (1986)
Diagnosis and treatment of the upper respiratory disease complex in swine. Agri-Practice 7: 35-40.

- Schmitz, J.A. and Olson, L.D. (1973)
Duration of viability and the growth and expiration rates of group E streptococci in soil. Applied Microbiology 25: 180-183.
- Scholl, W., Bernhard, J., Kohler, B., Senf, W., Zabke, J., Glaser, F. and Barbe, J. (1983)
[Immunoprophylaxis of streptococcal infections in unweaned piglets. Trial of a Streptococcus/Staphylococcus adsorbed vaccine for immunizing pregnant sows]. Archiv fur Experimentelle Veterinarmedizin 37: 511-526. (Abstracted in Veterinary Bulletin (1983), 53: 1014).
- Scholl, W., Michael, M. and Koban, I. (1976)
[Preliminary experience of house-specific vaccines to control streptococcal infection in piglets]. Monatshefte fur Veterinarmedizin 30: 890-893. (Abstracted in Veterinary Bulletin (1976), 46: 485).
- Schollum, L.M. and Blackmore, D.K. (1982)
Leptospirosis of pig farmers : the results of a serological survey. New Zealand Medical Journal 95: 299-301.
- Schoon, H.A. (1983)
Clinical and pathomorphological aspects of streptococcal leptomeningitis in pigs. In J.R. Walton, E.G. White and S.A. Hall (Eds.), Some Diseases of Emerging Importance to Community Trade. Commission of the European Communities, Luxembourg, pp. 12-27.
- Schoon, H.A., Schaible, G., Amsberg, G., Rosenbruch, M. and Hahn, G. (1980)
[Occurrence of leptomeningitis in the pig, caused by streptococci belonging to serotype R]. Praktische Tierarzt 61: 1035-1044. (Abstracted in Veterinary Bulletin (1981), 51: 395).
- Schueler, R.L., Morehouse, L.G. and Olson, L.D. (1973)
A direct fluorescent antibody test for identification of Group E streptococci. Canadian Journal of Comparative Medicine 37: 327-329.
- Schultz, R.A. (1986)
Swine pneumonia: Assessing the problem in individual herds. Veterinary Medicine 81: 757-762.
- Schultz, R.A. and Hoffmann, J. (1986)
Efficacy of a tylosin-ivermectin combination against Streptococcus suis 2 infection with secondary mange. Agri-Practice 7: 44-46.
- Schwabe, C.W., Riemann, H.P. and Franti, C.E. (1977)
Epidemiology in Veterinary Practice. Lea and Febiger, Philadelphia.
- Seaman, J.T. and Armstrong, K.J. (1979)
Veterinary Notes. New South Wales Department of Agriculture Report 13: 74. (Cited by Buddle et al (1981) Australian Veterinary Journal 57: 437-438).
- Sekiguchi, S. and Irons, E.E. (1917)
Chronic arthritis in swine. Journal of Infectious Disease 21: 526-539.

- Senf, W., Kraft, M. and Knofler, V. (1980)
[Control of streptococcal and staphylococcal infections in unweaned piglets]. Monatshefte für Veterinarmedizin 35: 503-506. (Abstracted in Veterinary Bulletin (1981), 51: 79-80).
- Sharrock, A. (1987)
Weaners: Streptococcus suis. In Pig Production, The University of Sydney Post-Graduate Committee in Veterinary Science, Proceedings No. 95, pp 1004-1005.
- Shearer, I.J. and Neal, G.D. (1972)
The establishment and maintenance of indwelling venous catheters in adult female pigs. New Zealand Veterinary Journal 20: 73-75.
- Shimizu, K., Nakagawa, M. and Ono, T. (1959)
Bacteriological studies on streptococci from bovine udder. 2. Distribution of Str. agalactiae in domestic animals and long term observations on the udder which harboured the organism. Japanese Journal of Veterinary Research 7: 203-214.
- Shneerson, J.M., Chattopadhyay, B., Murphy, M.F.G. and Fawcett, I.W. (1980)
Permanent perceptive deafness due to Streptococcus suis type 2 infection. The Journal of Laryngology and Otology 94: 425-427.
- Shuman, R.D. and Ross, R.F. (1975)
Streptococcosis. In H.W. Dunne and A.D. Leman (Eds.), Diseases of Swine (4th ed.) Iowa State University Press, pp. 630-649.
- Shuman, R.D., Wood, R.L., Wessman, G.E. and Nord, N. (1972)
Swine abscesses caused by Lancefield's group E streptococci. X. Specificity of the precipitin test for their detection with relation to streptococcal antigens of groups R and T, Streptococcus uberis and Staphylococcus aureus. Cornell Veterinarian 62: 61-73.
- Simmons, G.C. (1963)
A serological study of streptococci isolated from fluids and tissues of animal origin. Queensland Journal of Agricultural Science 20: 247-256.
- Simonella, P., Acciarri, C. and Di Giuseppe, F. (1970)
[Streptococcal encephalitis in piglets vaccinated against swine fever]. Atti della Societa Italiana delle Scienze Veterinarie 24: 679-681. (Abstracted in Veterinary Bulletin (1971), 41: 990).
- Smith, H.W. and Jones, J.E.T. (1963)
Observations on the alimentary tract and its bacterial flora in healthy and diseased pigs. Journal of Pathology and Bacteriology 86: 387-412.
- Soltys, M.A. (1979)
Introduction to Veterinary Microbiology. Penerbit Universiti Pertanian Malaysia. Serdang Selangor.
- Sourek, J. (1974)
Long-term preservation by freeze-drying of pathogenic bacteria of the Czechoslovak national collection of type cultures. International Journal of Systematic Bacteriology 24: 358-365

- St. John, V.S., Wilcock, B. and Kierstead, M. (1982)
Streptococcus suis type 2 infection in swine in Ontario : A review of clinical and pathological presentations. Canadian Veterinary Journal 23: 95-97.
- Stratford, B.C. (1977)
An atlas of medical microbiology. Common human pathogens. Blackwell Scientific Publications, Oxford.
- Straw, B. (1986)
A look at the factors that contribute to the development of swine pneumonia. Veterinary Medicine 81: 747-756.
- Strojna, S., Semka, Z., Molenda, J., Kozyczak, J. and Janas, P. (1978)
[Streptococcal meningoencephalitis in piglets]. Medycyna Weterynaryjna 34: 339-342. (Abstracted in Veterinary Bulletin (1979), 49: 161-162).
- Sugimoto, C., Tominaga, K., Kashiwazaki, M. and Azuma, R. (1985)
Serological grouping, biochemical properties and drug susceptibility of streptococci isolated from pigs in Japan. In Y. Kimura, S. Kotami and Y. Shiokawa (Eds.). Recent Advances in Streptococci and Streptococcal diseases. Proceedings of the 9th Lancefield International Symposium on Streptococci and Streptococcal Diseases. Chertsey U.K. Reedbooks Ltd., pp. 74-75. (Abstracted in Veterinary Bulletin (1986) 56: 447).
- Swann, A.I. and Kjar, H.A. (1980)
Streptococcal infection as a cause of reproductive tract problems of swine. Veterinary Microbiology 5: 135-142.
- Swe, T. (1976)
A study of spontaneous and experimental streptococcal meningitis and arthritis in the pig. M.Phil. dissertation, Royal Veterinary College, University of London. (Cited by Clifton-Hadley, F.A. and Alexander, T.J.L. (1981) The Pig Veterinary Society Proceedings 8: 8-17).
- Swenson, M.J. (1970)
Physiologic properties, cellular and chemical constituents of blood. In M.J.Swenson (Ed.) Dukes' Physiology of Domestic Animals (8th ed.). Cornell University Press, London.
- Swenson, M.J. (1975)
Composition of body fluids. In H.W.Dunne and A.D.Leman (Eds.), Diseases of Swine (4th ed.). Iowa State University Press, Iowa. pp. 38-71.
- Swift, H.F., Wilson, A.T. and Lancefield, R.C. (1943)
Typing group A hemolytic streptococci by M precipitin reactions in capillary pipettes. Journal of Experimental Medicine 78: 127-133.
- Switzer, W.P. and Ross, R.F. (1975)
Mycoplasmal diseases. In H.W.Dunne and A.D.Leman (Eds.), Diseases of Swine (4th ed.) Iowa State University Press, Iowa. pp. 741-764.

- Tai, J.Y., Gotschlich, E.C. and Lancefield, R.C. (1979)
Isolation of type-specific polysaccharide antigen from group B type 1b streptococci. Journal of Experimental Medicine 149: 58-66.
- Talkington, F.D., Schotts, E.B., Wooley, R.E., Whitehead, W.K. and Dobbins, C.H. (1981)
Introduction and re-isolation of selected Gram-positive bacteria from fermented edible wastes. American Journal of Veterinary Research 42: 1302-1305.
- Thornton, E.J. (1987)
Weaner Diseases. In Pig Production, Proceedings No. 95, The University of Sydney Post-Graduate Committee in Veterinary Science, pp. 835-846.
- Tillotson, G.S. (1982)
An evaluation of the API-20 STREP system. Journal of Clinical Pathology 35: 468-472.
- Timoney, J.F. and Berman, D.T. (1970)
Erysipelothrix arthritis in swine : Bacteriologic and immunopathologic aspects. American Journal of Veterinary Research 31: 1411-1421.
- Tizard, I.R. (1977)
An Introduction to Veterinary Immunology. W.B.Saunders Company, Philadelphia.
- Turner, G.V.S. (1978)
Porcine arthritis and meat hygiene in South Africa. Journal of the South African Veterinary Association 49: 40-44.
- Turner, G.V.S. (1982)
A microbiological study of polyarthritis in slaughter pigs. Journal of the South African Veterinary Association 53: 99-101.
- Turner, G.V.S., Halland, L. and Erasmus, M. (1980)
Inoculation of pigs with Streptococcus spp. isolated from arthritic porcine joints. Journal of the South African Veterinary Association 51: 9-13.
- Twort, C.H.C. (1981)
Group R streptococcal meningitis (Streptococcus suis type 2) : a new industrial disease? British Medical Journal 282: 523-524.
- Vaissaire, J., Lagadic, M., Menec, M. Le., Kobische, M., Carnero, R., Laroche, M. and Mirial, G. (1984)
[Streptococcal infections of swine]. Bulletin Mensuel de la Societe Veterinaire Pratique de France 68: 191-192. (Abstracted in Veterinary Bulletin (1984), 54: 818).
- Vaissaire, J., Menec, M. Le., Vigouroux, A., Salingardes, F., Carnero, R. and Laroche, M. (1983)
[Streptococcosis caused by group R streptococci in swine. Its importance, possibility of transmission to man. A zoonosis of the future]. Bulletin de l'Academie Veterinaire de France 56: 331-338.

- van der Schaaf, A., van Doorsen, C.A., Donker-Voet, J. Frik, J.F. and van Maanen, P.H.A.M. (1961)
[Survey of examinations of specimens in the Institute for Bacteriology, Veterinary Faculty, Utrecht in 1959]. Tijdschrift voor Diergeneeskunde 86: 525-536. (Abstracted in Veterinary Bulletin (1961), 31: 574).
- Vecht, U., Leengoed, L.A.M.G. van and Verheijen, E.R.M. (1985)
Streptococcus suis infections in pigs in the Netherlands. 1. Veterinary Quarterly 7: 315-321. (Abstracted in Veterinary Bulletin (1986), 56: 185).
- Voller, A., Bidwell, D. and Bartlett, A. (1976)
Microplate enzyme immunoassays for the immunodiagnosis of virus infections. In N.R. Rose and H. Friedman (Eds.). Manual of Clinical Immunology. American Society for Microbiology, Washington, D.C., p. 506.
- Voller, A., Bidwell, D.E. and Bartlett, A. (1980)
Microplate Elisa and its application. In R. Malvano (Ed.) Developments in Clinical Biochemistry. Volume 1. Immunoenzymatic assay techniques. Martinus Nijhoff Publishers, The Hague. pp. 104-115.
- Von Bocklisch, H. and Zepezauer, V. (1979)
Streptococcal infection of swine. Monatshefte fur Veterinarmedizin 34: 841-846.
- Walton, J.R. (1983)
The underestimated health hazard. pro Veterinario 3: 1,10.
- Warriss, P.D. and Leach, T.M. (1978)
The influence of slaughter method on the residual blood content of meat. Journal of the Science of Food and Agriculture 29: 608-610
- Wessman, G.E. (1986)
Biology of the group E streptococci : a review. Veterinary Microbiology 12: 297-328.
- Watson, T.S. and Bertram, J.M. (1982)
Some observations on mother-infant interactions in the pig (Sus scrofa). Applied Animal Ethology 9: 253-261.
- Wheeler, G. (1983)
Meningitis in pigs. The Pig Veterinary Society Proceedings 12: 108-112.
- Wilkin-Sims, L.D. (1981)
Nervous diseases of pigs. In Pigs, Proceedings Number 56. The University of Sydney Postgraduate Committee in Veterinary Science, Sydney, Australia pp. 245-272.
- Williams, D.M., Lawson, G.H.K. and Rowland, A.C. (1973)
Streptococcal infection in piglets : The palatine tonsils as portals of entry for Streptococcus suis. Research in Veterinary Science 15: 352-362.
- Williams, D.M. and Rowland, A.C. (1972)
The palatine tonsils of the pig - an afferent route to the lymphoid tissue. Journal of Anatomy 113: 131-137.

- Wilson, G.S. and Miles, A.A. (1955)
Topley and Wilson's principles of bacteriology and immunity.
 Vol. 2, (4th ed.), Edward Arnold Limited, London.
- Windsor, R.S. (1977)
 Meningitis in pigs caused by Streptococcus suis type 2.
Veterinary Record 101: 378-379.
- Windsor, R.S. (1978)
 Streptococcal infections in young pigs. In C.S.G. Grunsell and
 F.W.G. Hill (Eds.), Veterinary Annual (18th ed.). Scientifica,
 Bristol, pp. 134-143.
- Windsor, R.S. (1980)
 The epidemiology of streptococcal infections with special
 reference to Streptococcus suis. In N.C. Nielsen, P. Høgh and N.
 Bille (Eds.), Proceedings of the International Pig Veterinary
Proceedings. Reprint, Copenhagen, p. 370.
- Windsor, R.S. and Elliot, S.D. (1975)
 Streptococcal infection in young pigs. 4. An outbreak of
 streptococcal meningitis in weaned pigs. Journal of Hygiene 75:
 69-78.
- Wittig, von W. and Kunter, E. (1975)
 S strain streptococcal infection of nursed piglets. Monatshefte
fur Veterinarmedizin 30: 894-895.
- Woods, R.D. and Ross, R.F. (1976)
 Streptococcosis of swine. Veterinary Bulletin 46: 397-400.
- Wright, H.D. (1927)
 Experimental pneumococcal septicaemia and anti-pneumococcal
 immunity. The Journal of Pathology and Bacteriology 30: 185-252.
- Yang, W.Y. and Wang, Q. (1985)
 [Identification of serological groups of streptococci in
 septicaemia and suppurative arthritis in piglets]. Chinese
Journal of Veterinary Science and Technology 5: 13-15.
 (Abstracted in Veterinary Bulletin (1986) 56: 675).
- Yurukov, M. and Ganovski, D. (1981)
 [Isolation of group D streptococci from sows with cystitis and
 pyelonephritis]. Veterinarno-Meditsinski Nauki 18: 28-32.
 (Abstracted in Veterinary Bulletin (1982), 52: 371).
- Zanen, H.C. (1983)
 Incidence of complications of group R streptococcal infections
 in man in the Netherlands. In J.R. Walton, E.G. White and S.A.
 Hall (Eds.), Some Diseases of Emerging Importance to Community
Trade. Commission of the European Communities, Luxembourg, pp.
 46-53.
- Zanen, H.C. and Engel, H.W.B. (1975)
 Porcine streptococci causing meningitis and septicaemia in man.
The Lancet 1: 1286-1288.
- Zhelev, V., Khristov, S., Gerov, K. and Pavlov, N. (1960)
 [Endemic non-purulent meningoencephalitis associated with
 diplococci in pigs]. Izvestiya na Instituta za zhivotnovodstvo
"Georgi Dimitrov" 8: 65-74. (Abstracted in Veterinary Bulletin
 (1961), 31: 238).

APPENDIX I

REAGENTS USED IN TRADITIONAL MICROBIOLOGICAL TECHNIQUES

Carbohydrate solutions

| | |
|-------|--|
| 10 g | Peptone ¹ |
| 3 g | Beef extract ² |
| 5 g | Sodium Chloride |
| 1 l | Distilled water |
| 10 ml | 0.2% Phenol Red |
| | (1 g phenol red ¹ in 57 ml of 0.05 M Na OH) |

All ingredients were mixed and dissolved in distilled water and autoclaved at 121°C for 15 minutes. After sterilizing 30 ml of 10% filtered carbohydrate solution (see below) was added and the solution dispensed aseptically in 3 ml lots into bijoux containers.

Carbohydrates

Arabinose¹
Mannitol³
Sorbitol¹
Ribose³
Trehalose¹
Raffinose⁴
Inulin¹
Glycogen³
Salacin¹

¹ Difco Laboratories, Detroit, Michigan, U.S.A.

² GIBCO Diagnostics, Madison, Wisconsin, U.S.A.

³ Sigma, St. Louis, U.S.A.

⁴ BBL, Cockeysville, Maryland, U.S.A.

Other Microbiological Reagents

Aesculin³

M.R./V.P.⁵

Methylene Blue Milk

Litmus Milk¹

Arginine³

0.04% meta cresol purple⁶

(Prepared by grinding 200 mg meta cresol purple powder in 26.7 ml N/50 NaOH, then diluting to 500 ml with distilled water).

⁵ Merck, Darmstadt

⁶ BDH Chemicals Ltd., Poole, England

APPENDIX II

REAGENTS FOR THE INDIRECT FLUORESCENT ANTIBODY TEST (I.F.A.T.)

Phosphate buffered saline (P.B.S.)

| | |
|---------|---|
| 40.0 g | Sodium Chloride |
| 1.0 g | Potassium di-hydrogen phosphate KH_2PO_4 |
| 14.5 g | Di-sodium hydrogen orthophosphate dodecahydrate ($\text{Na}_2\text{HPO}_4 \cdot 12\text{H}_2\text{O}$) |
| 1.0 g | Potassium chloride |
| 5000 ml | Distilled water |

Buffered glycerol mounting medium

- (a) sodium carbonate
- (b) sodium hydrogen carbonate
- (c) glycerine

A 0.5 M solution of sodium carbonate was made by dissolving 5.3 g in 100 ml of distilled water and a 0.5 M solution of sodium hydrogen carbonate by dissolving 4.2 g in 100 ml of distilled water. Twenty-five ml of the 0.5 M sodium carbonate solution was mixed with 75 ml of 0.5 M sodium hydrogen carbonate solution. Ten ml of this mixture was added to 90 ml of glycerine to produce a mounting buffer of pH 8.5.

APPENDIX III

REAGENTS USED FOR ELISA TECHNIQUE

0.05 M Carbonate-bicarbonate buffer pH 9.6

1.59 g Sodium carbonate
 2.93 g sodium bicarbonate
 1000 ml distilled water

Ammonium acetate-carbonate buffer

(a) Ammonium carbonate $\text{NH}_4\text{HCO}_3 \cdot \text{NH}_2\text{COONH}_4$
 (b) glacial acetic acid

An ammonium carbonate solution was made by dissolving 1.5713 g in 1 litre of distilled water. This solution was acidified to a pH of 8.2 by the gradual addition of glacial acetic acid.

Phosphate buffered saline - Tween (PBS-Tween) pH 7.4

40.0 g sodium chloride
 1.0 g potassium di-hydrogen phosphate
 14.5 g di-sodium hydrogen orthophosphate
 1.0 g potassium chloride
 2.5 ml polyoxyethylene sorbitan monoalaurate (Tween 20)⁷
 5000 ml distilled water

PBS-Tween-BSA

100 ml PBS-Tween
 1 g Bovine Serum Albumin (BSA)⁸

⁷ Sigma Chemical Company, St. Louis, U.S.A.

⁸ Immuno-Chemical Product Ltd, Auckland, New Zealand

Citric-phosphate buffer

10.5 g Citric Acid
14.2 g di-sodium hydrogen orthophosphate anhydrous
500 ml distilled water

Substrate

20 ml citric-phosphate buffer
10 μ g ortho-phenylenediamine⁹ (OPD)
10 μ l hydrogen peroxide

When the OPD was dissolved in the buffer, the solution was kept in the dark until just before use when the hydrogen peroxide was added.

⁹Merck, Darmstadt

APPENDIX IVBUFFERS USED IN INVESTIGATING THE SURVIVAL OF *S. SUIS*Citric-phosphate buffer pH 5.0

24.3 ml of 0.1 M solution of Citric acid
(19.21 g in 1000 ml)
25.7 ml of 0.2 M solution of dibasic sodium phosphate
(28.39 g in 1000 ml)
50.0 ml of distilled water

Citric-phosphate buffer pH 6.4

15.4 ml of 0.1 M solution of Citric acid
34.6 ml of 0.2 M solution of dibasic sodium phosphate
50.0 ml of distilled water

Phosphate buffer pH 6.4

73.5 ml of 0.2 M solution of monobasic sodium phosphate
(31.2 g in 1000 ml)
26.5 ml of 0.2 M solution of dibasic sodium phosphate
(28.39 g in 1000 ml)
100.0 ml of distilled water

Phosphate buffer pH 7.4

19 ml of 0.2 M solution of monobasic sodium phosphate
81 ml of 0.2 M solution of dibasic sodium phosphate
100 ml of distilled water

Phosphate buffer pH 8.0

5.3 ml of 0.2 M solution of monobasic sodium phosphate
94.7 ml of 0.2 M solution of dibasic sodium phosphate
100.0 ml of distilled water

Carbonate-bicarbonate buffer pH 9.2

4 ml of 0.2 M solution of anhydrous sodium carbonate
(21.2 g in 1000 ml)
46 ml of 0.2 M solution of sodium bicarbonate
(16.8 g in 1000 ml)
150 ml of distilled water

Carbonate-bicarbonate buffer pH 10.6

42.5 ml of 0.2 M solution of anhydrous sodium carbonate
7.5 ml of 0.2 M solution of sodium bicarbonate
150.0 ml of distilled water

SURVIVAL OF S. SUIIS IN THE LABORATORY

FIGURE 1

SURVIVAL OF S. SUIIS IN CITRATE-PHOSPHATE BUFFER (pH 5.0)

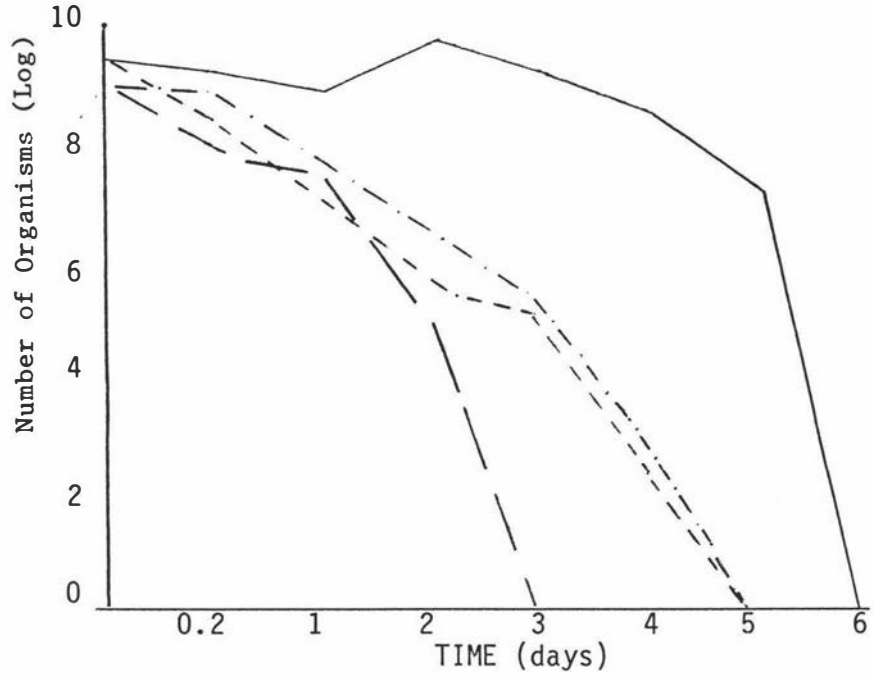
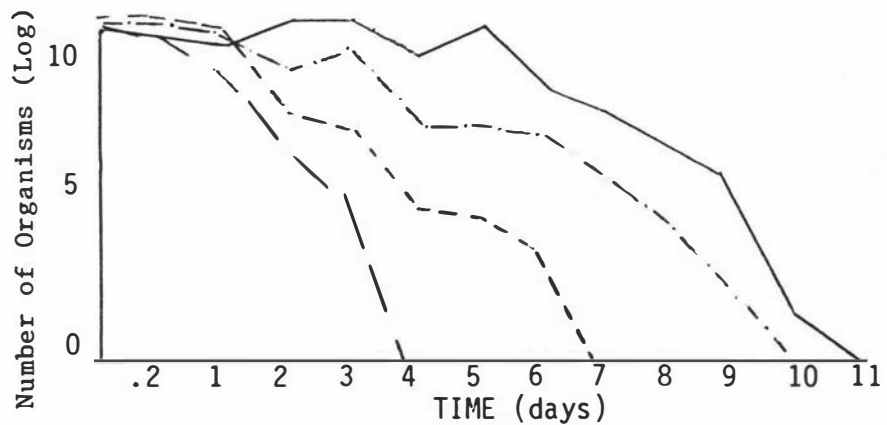

FIGURE 2

SURVIVAL OF S. SUIIS IN CITRATE-PHOSPHATE BUFFER (pH 6.4)



- S. suis type 2 field strain
- S. suis type 2 field strain with 5% faeces
- S. suis type 1 field strain
- S. suis type 1 field strain with 5% faeces

FIGURE 3

SURVIVAL OF S. SUIIS IN PHOSPHATE BUFFER (pH 6.4)

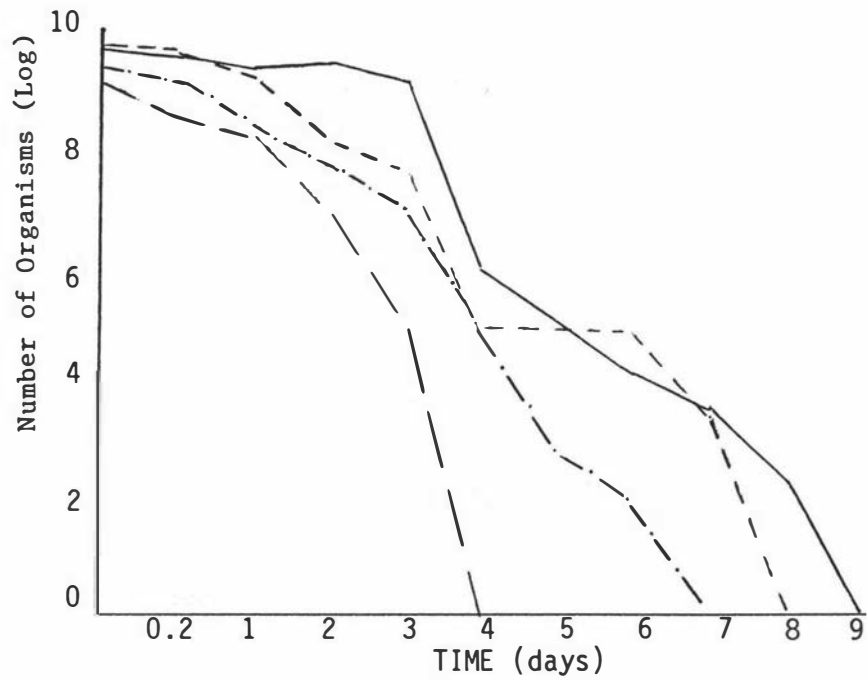

FIGURE 4

SURVIVAL OF S. SUIIS IN PHOSPHATE BUFFER (pH 7.4)

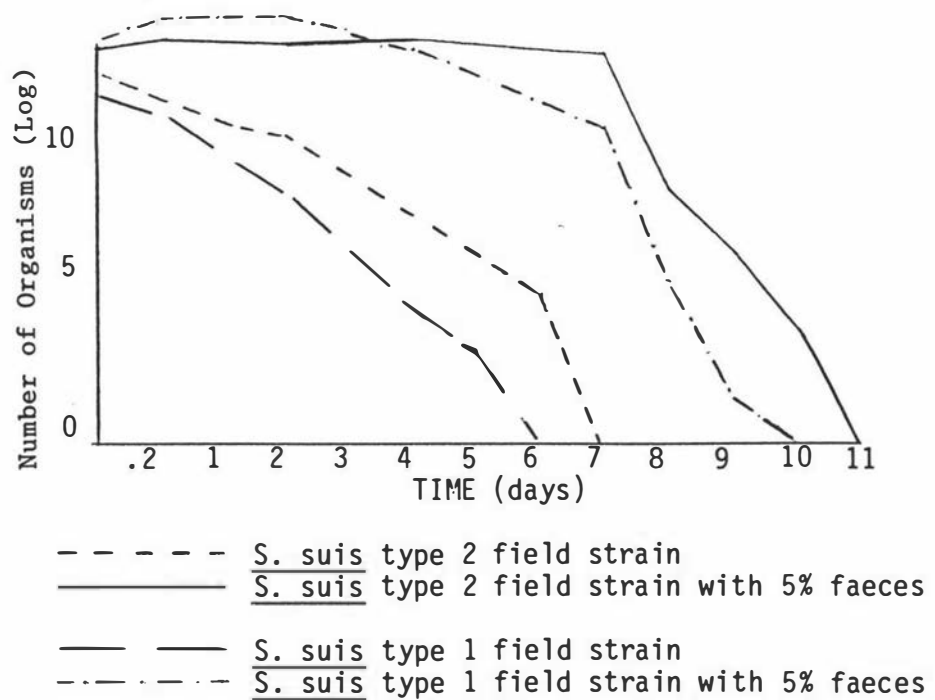

FIGURE 5

SURVIVAL OF *S. SUIIS* IN PHOSPHATE BUFFER (pH 8.0)

FIGURE 6

SURVIVAL OF *S. SUIIS* IN CARBONATE-BICARBONATE BUFFER (pH 9.2)

- *S. suis* type 2 field strain
- *S. suis* type 2 field strain with 5% faeces
- *S. suis* type 1 field strain
- · - · - · *S. suis* type 1 field strain with 5% faeces

FIGURE 7

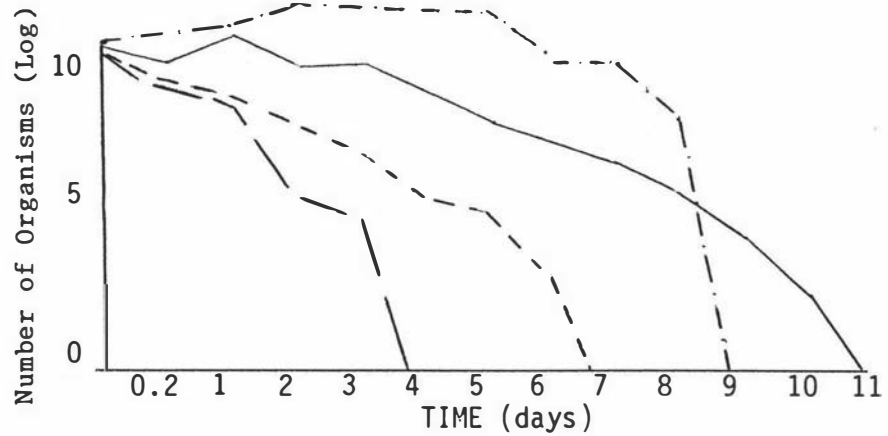
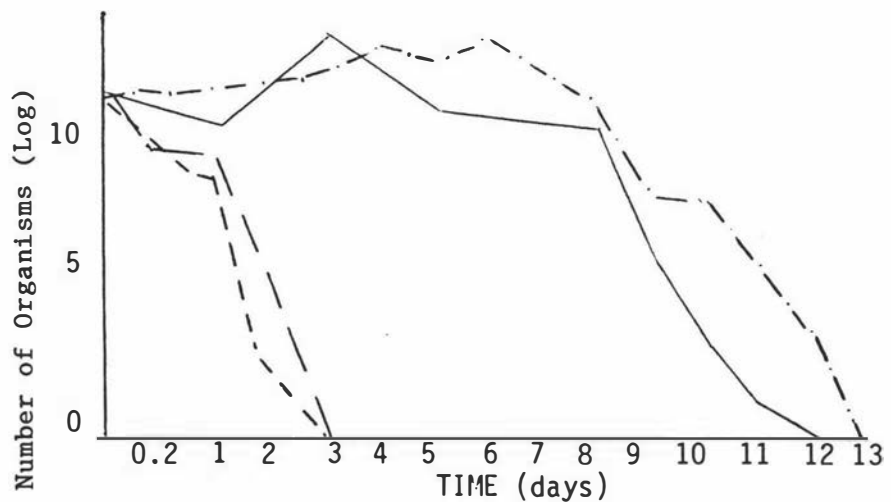
SURVIVAL OF S. SUIIS IN CARBONATE-BICARBONATE BUFFER (pH 10.6)

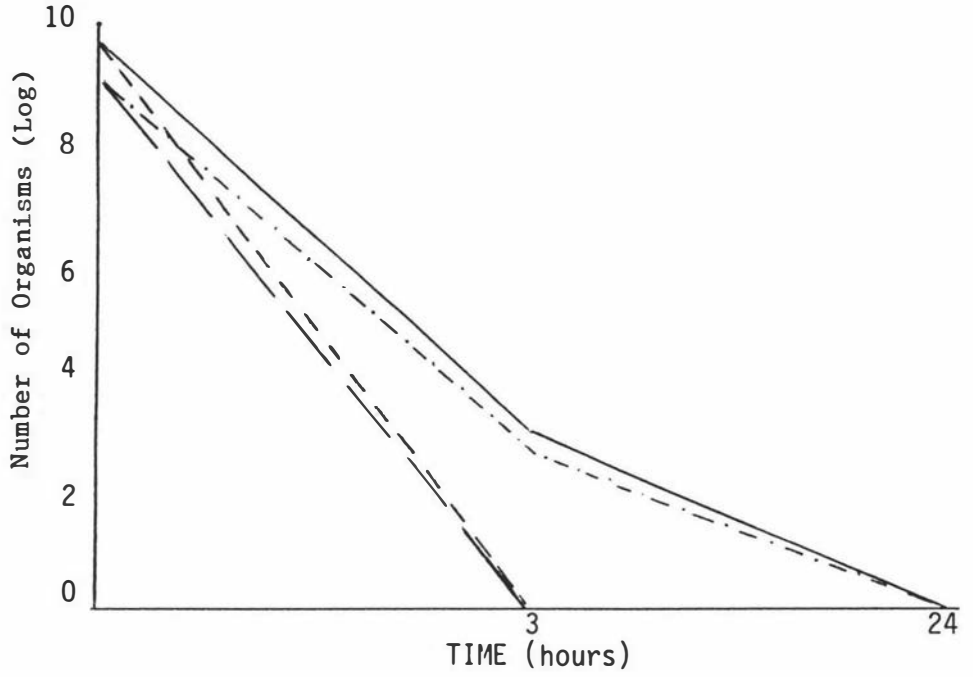

- - - - - S. suis type 2 field strain
- S. suis type 2 strain culture
- S. suis type 1 field strain
- · - · - · - S. suis type 1 strain culture

FIGURE 8
SURVIVAL OF S. SUIIS AT -20°C

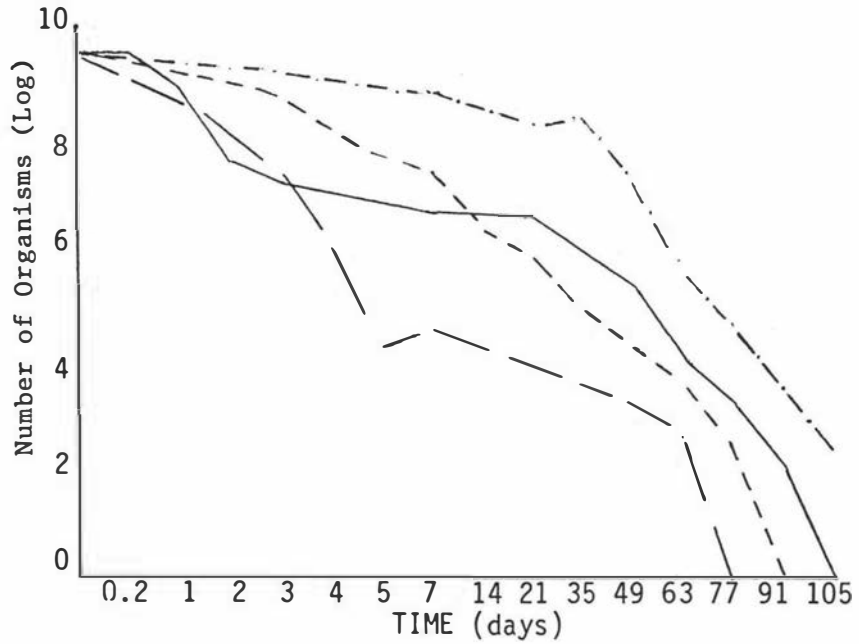
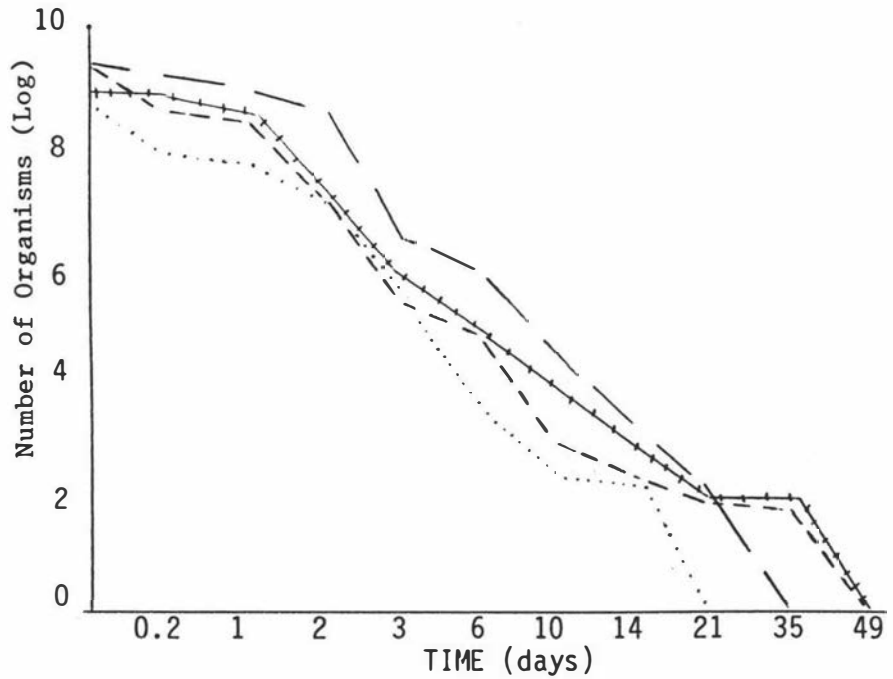

FIGURE 9
SURVIVAL OF S. SUIIS AT 4°C



- *S. suis* type 2 field strain
- *S. suis* type 2 field strain with 5% faeces
- + + + + + *S. suis* type 2 strain culture
- *S. suis* type 1 field strain
- - - - - *S. suis* type 1 field strain with 5% faeces
- *S. suis* type 1 strain culture

FIGURE 10
SURVIVAL OF S. SUIIS AT ROOM TEMPERATURE (17^o to 24^oC)

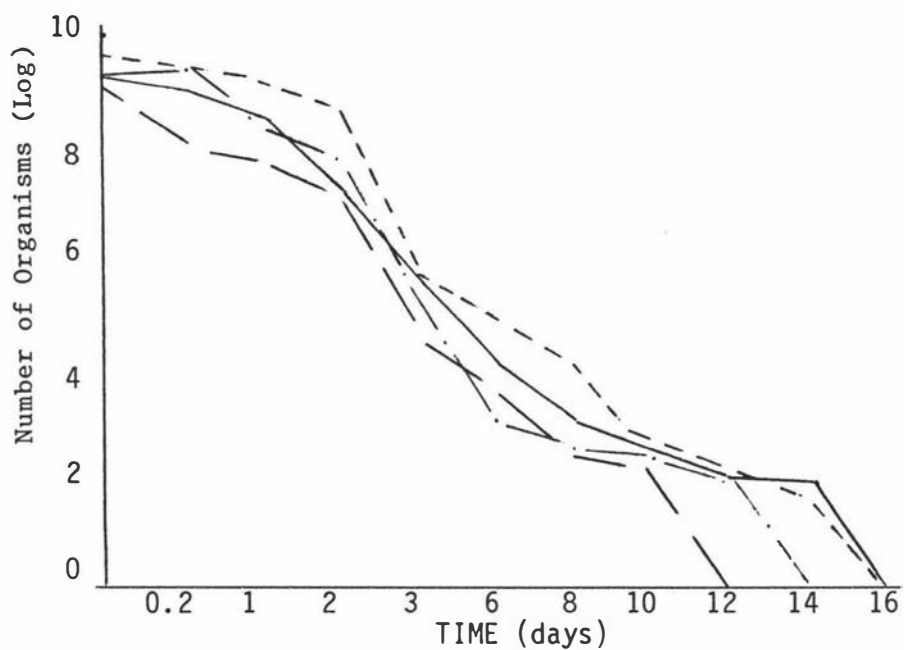
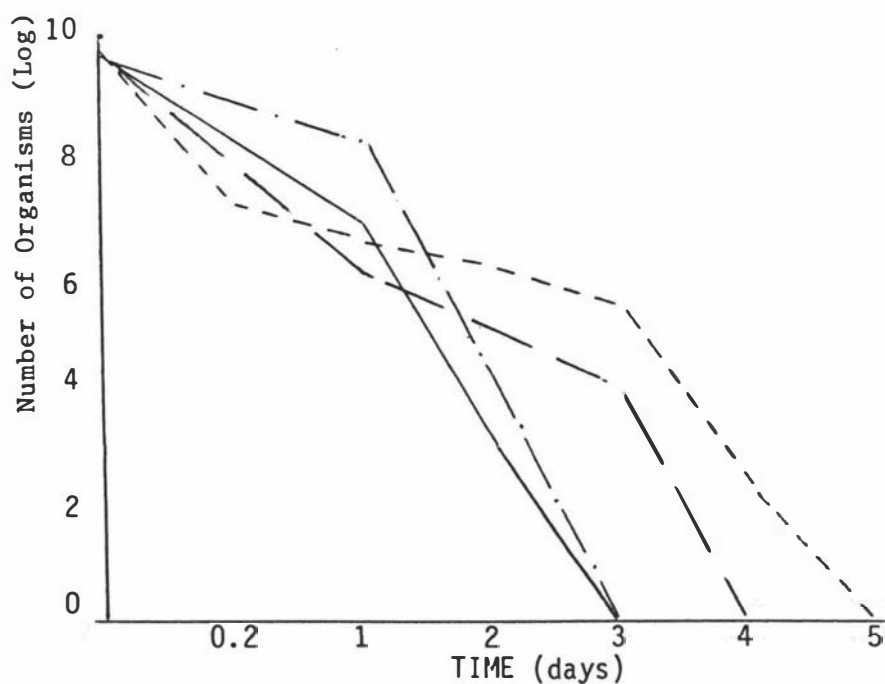

FIGURE 11
SURVIVAL OF S. SUIIS AT 37^oC



- · - · - · - S. suis type 2 field strain
 ————— S. suis type 2 strain culture
 - - - - - S. suis type 1 field strain
 - - - - - S. suis type 1 strain culture

FIGURE 12
SURVIVAL OF S. SUIIS AT 45°C

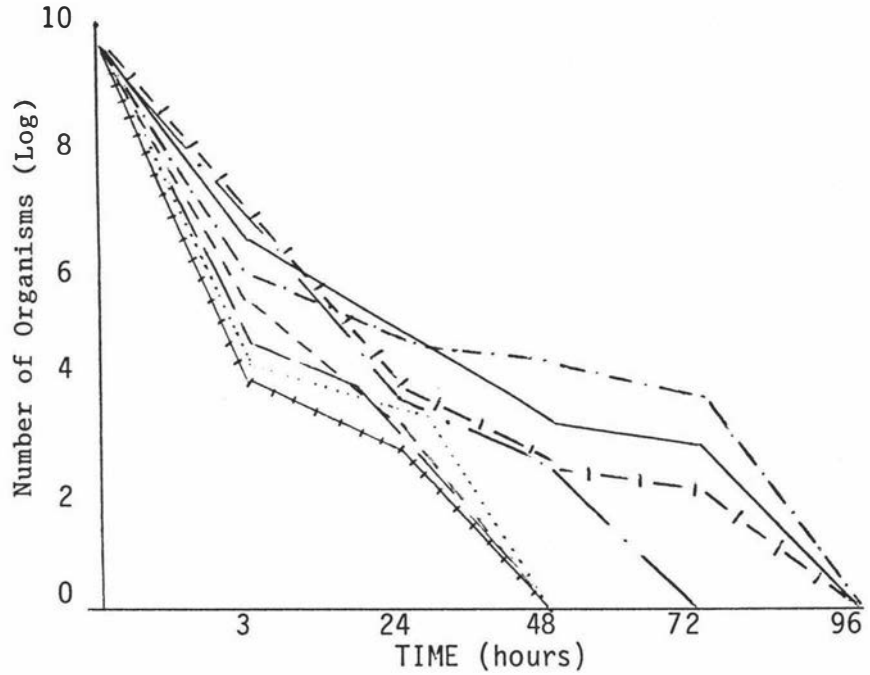
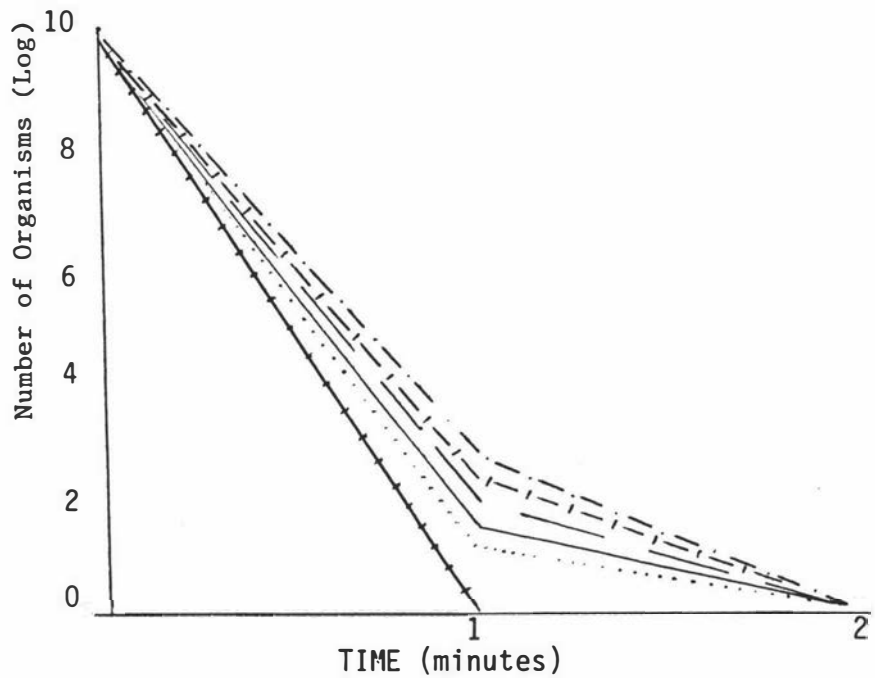

FIGURE 13
SURVIVAL OF S. SUIIS AT 60°C



- S. suis type 2 field strain
- + + + + + S. suis type 2 strain culture
- — — S. suis type 1 field strain
- S. suis type 1 strain culture
- — — S. suis type 2 field strain with 5% faeces
- — — S. suis type 2 strain culture with 5% faeces
- - - S. suis type 1 field strain with 5% faeces
- | - | - | S. suis type 1 strain culture with 5% faeces

FIGURE 14

SURVIVAL OF S. SUIIS IN A 20% SALINE SOLUTION

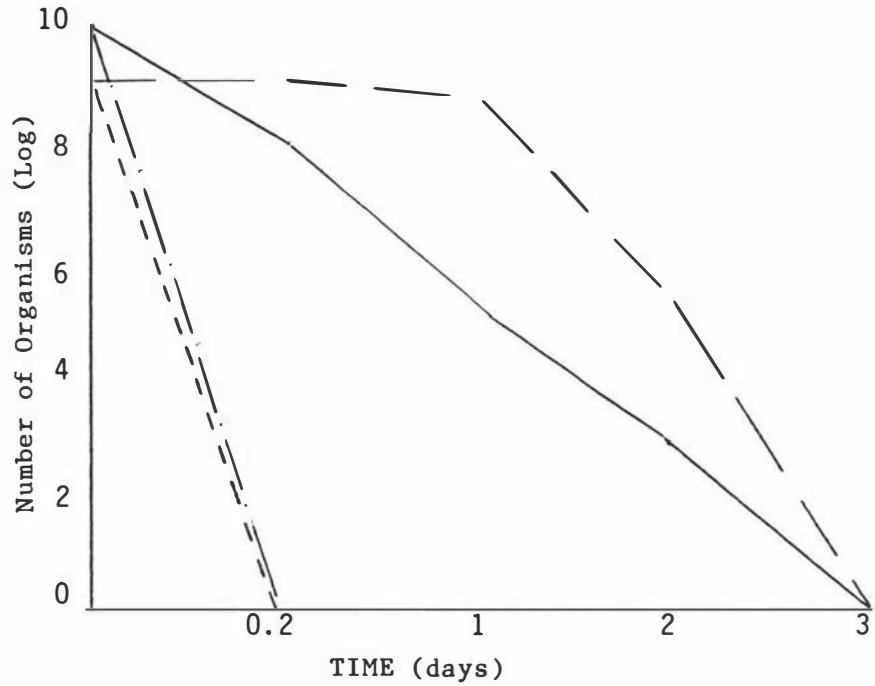

FIGURE 15

SURVIVAL OF S. SUIIS IN A 10% SALINE SOLUTION

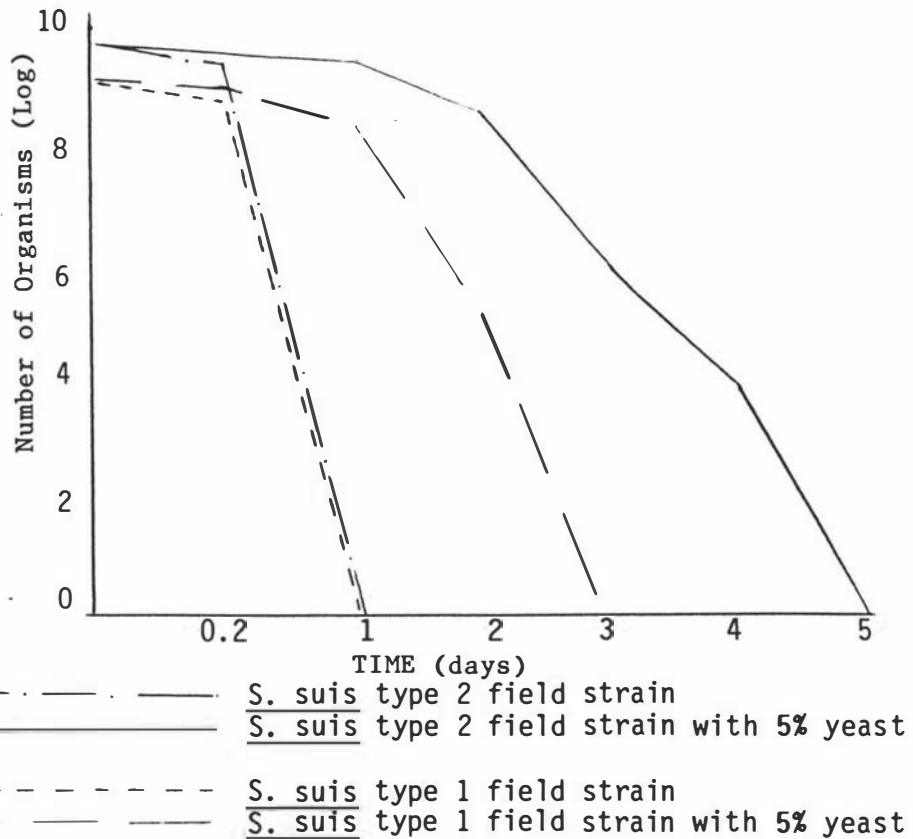

FIGURE 16

SURVIVAL OF S. SUIIS IN A 6.5% SALINE SOLUTION

FIGURE 17

SURVIVAL OF S. SUIIS IN A 2.5% SALINE SOLUTION

- · — · — S. suis type 2 field strain
- S. suis type 2 field strain with 5% yeast
- - - - S. suis type 1 field strain
- — — — S. suis type 1 field strain with 5% yeast

FIGURE 18

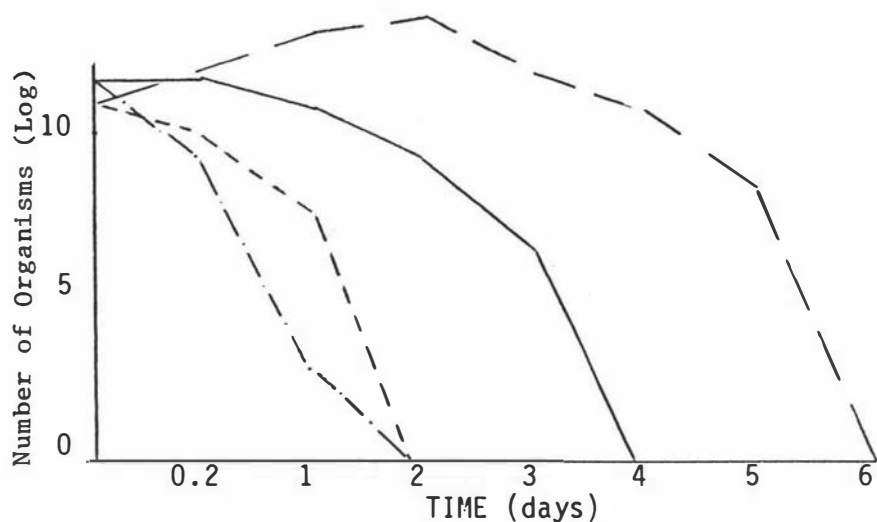
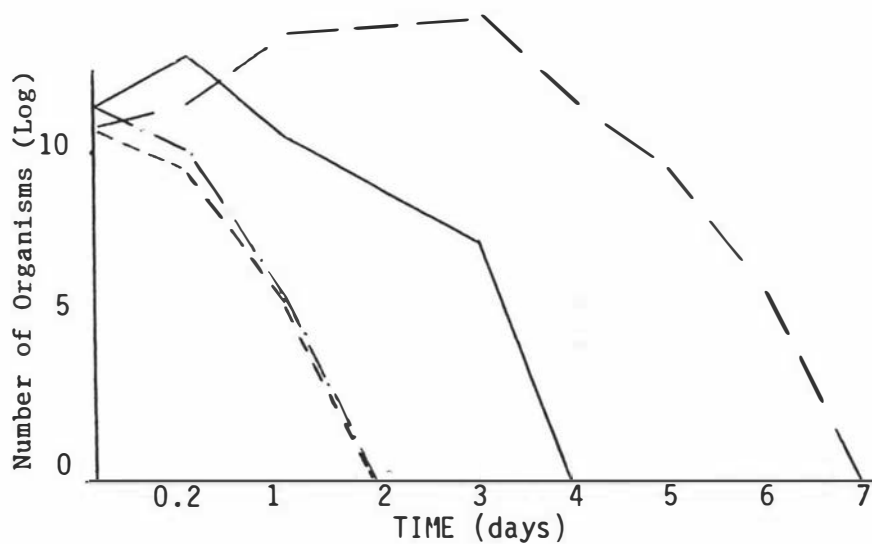
SURVIVAL OF S. SUIIS IN A 0.9% SALINE SOLUTION

FIGURE 19

SURVIVAL OF S. SUIIS IN A 0.1% SALINE SOLUTION

- · — · — *S. suis* type 2 field strain
- *S. suis* type 2 field strain with 5% yeast
- - - - - *S. suis* type 1 field strain
- *S. suis* type 1 field strain with 5% yeast

FIGURE 20

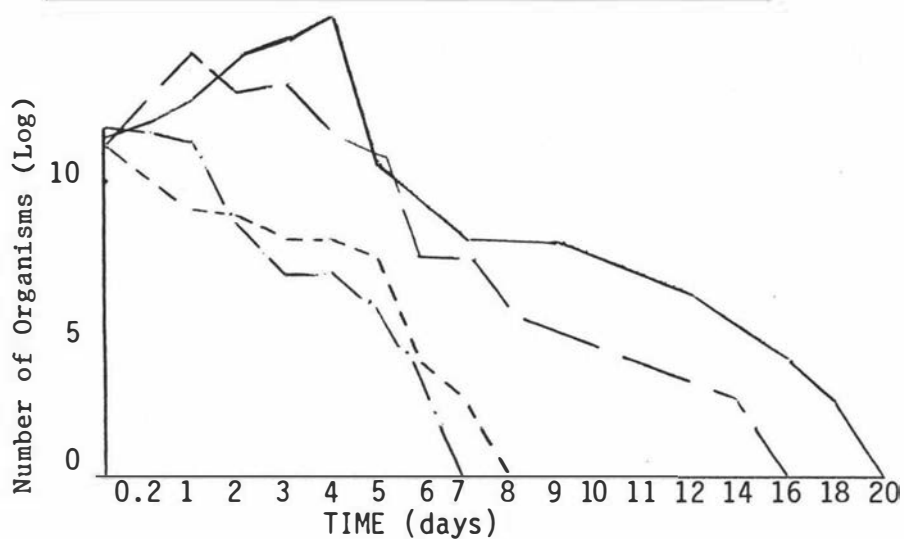
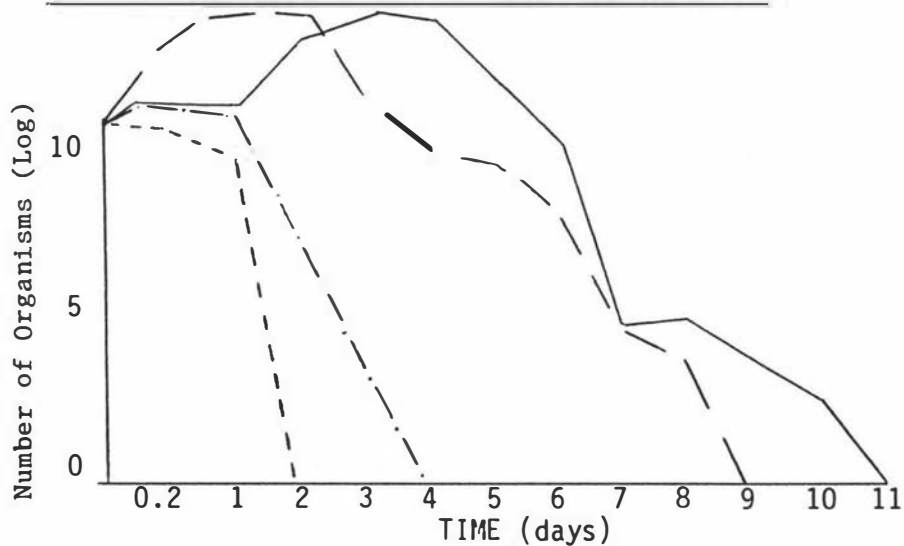
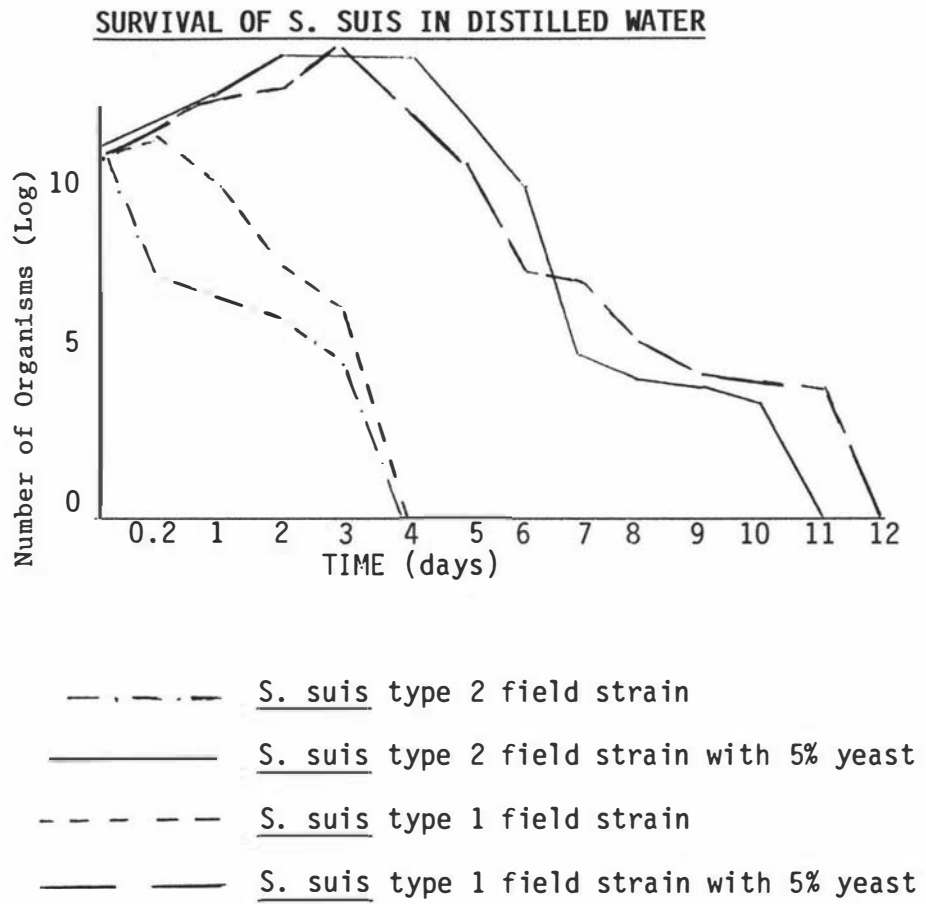

APPENDIX VISkin Disinfectant

| | |
|---------|--------------------|
| 200 ml | Hibitane |
| 300 ml | Distilled water |
| 1500 ml | Methylated spirits |

Heparinized Saline

| | |
|--------|---|
| 1 ml | Heparin ¹⁰ (25,000 units/ml) |
| 999 ml | Phosphate buffered saline |

¹⁰ Weddel Pharmaceuticals, Sydney, Australia