

## **Performance of voice and video conferencing over ATM and Gigabit Ethernet backbone networks**

JASON SCHREIBER, MEHRDAD KHODAI JOOPARI, M. A. RASHID

*Information Engineering. Institute of Information & Mathematical Sciences  
Massey University at Albany, Auckland, New Zealand  
m.a.rashid@massey.ac.nz*

Gigabit Ethernet and ATM network technologies have been modeled as campus network backbones for the simulation-based comparison of their performance. Real-time voice and video conferencing traffic is used to compare the performance of both backbone technologies in terms of response times and packet end-to-end delays. Simulation results show that Gigabit Ethernet has been able to perform the same and in some cases better than ATM as a backbone network for video and voice conferencing providing network designers with a cheaper solution to meet the growing needs of bandwidth-hungry applications in a campus environment.

---

### **1 Introduction**

Asynchronous Transfer Mode (ATM) well suited for multimedia applications due to its intrinsic characteristics of supporting multiple streamlines with varying data rates and Quality of Service (QoS) features that can be adjusted to users' needs. On the other hand Ethernet had to evolve in order to match ATM's functionality. It did this using less complexity and cost than ATM, this resulted in Gigabit Ethernet. Gigabit Ethernet is a Data Link and Physical Layer technology only and as such it requires no changes to higher layer protocols or applications (although it may be appropriate to "tune" the behaviour of higher layer protocols and applications to properly take advantage of the higher bandwidth available). Additionally the use of Ethernet at 10/100/1000 Mbps allows seamless integration among desktop, workgroup, and campus interconnections, while ATM requires ATM LAN Emulation (LANE) to interconnect legacy networks.

A number of key differences exist between these two backbone technologies, the biggest difference being that ATM is a 53-byte-frame connection-oriented technology while Gigabit Ethernet is a 512-byte-frame (minimum) connectionless technology. Due to the increased number of networks in existence and their greater complexity, designing new systems and improving the performance of existing ones has become more difficult and time consuming. It is therefore more practical to use modeling and simulation tools such as OPNET to deal with this complexity. It provides an opportunity to examine the higher level and more complex behaviour of ATM networks as well as the lower Data Link and Physical Layers of Gigabit Ethernet networks. In a study [1] on issues and possible solutions in managing multimedia traffic over ATM networks the authors suggested feedback-based congestion control for multimedia traffic whose characteristics cannot be fully defined a priori and prediction-based control

for accurate model of the traffic stream. Other techniques such as random cell discard scheme, frame dropping or block dropping options may also be applied for controlling bandwidth while communication multimedia over the ATM network. In a similar paper [2] the authors discussed the traffic shaping strategy for transmission of MPEG compressed video stream over the IETF (Internet Engineering Task Force) defined guaranteed service (GS) providing Quality of Service (QoS) guarantee to realtime applications. An analytical model [3] of the ATM's AAL2 packet voice multiplexing with bit dropping (BD) showed significantly higher capacity maintaining the same mean opinion score (MOS). Gigabit Ethernet [5,6,7,8] has been in the backbone use for several years competing with the ATM switches. Although Gigabit Ethernet does not provide QoS guarantees like the ATM, there are higher level protocols such as RSVP (Resource reservation Protocol) that can be utilized for time-critical applications. Our goal in this paper is to compare the performance of ATM and Gigabit Ethernet technologies employed as high speed high band-width backbone networks deployed for multimedia communications especially with real time voice and video conferencing applications.

Optimized Network Engineering Tools (OPNET) [9] is a powerful comprehensive engineering system that can be used to model communication systems and predict network performance. It is capable of simulating large communications networks with detailed protocol modeling and performance analysis. Its accuracy and ease-of-use make it a valuable tool for network planners and administrators. OPNET supports modeling efforts with a system of interrelated programs, model libraries, and data files. The key features of this program include object orientation, graphical specification, automated model creation, an extensive model suite, integrated analysis tools, and animation support. The OPNET system consists of a set of well-behaved application programs, object code libraries, and data files. The OPNET components interact with the operating system and the user in a predictable manner that is common to other programs. For instance, OPNET programs run as regular user processes and do not interfere with the operating system's control of the computer. OPNET provides an opportunity for developers and researchers of communication networks to develop a feel for what is happening in complex network environments by changing parameters and seeing the corresponding impact through performance statistics and animations.

## 2 Network modelling

Following traditional models, we took decision to simulate a tri-angle type backbone network with different large Ethernet and Token Ring legacy LANs connected at the end points. Figure 1 shows the two identical Network topologies representing an ATM and a Gigabit Ethernet backbone. The thick black lines represent the backbone links (ATM OC24 or Gigabit Ethernet) while the slightly thinner blue lines represent Ethernet 100BaseT links. The topologies of the Ethernet and Token Ring legacy LANs are shown in figure 2 that we used as connected networks with the backbone networks. Although the networks are exactly the same, there are additional routers and LANE servers in the ATM network. Each subnet in the network diagrams (represented by an octagon) consists of 10 Ethernet or Token Ring workstations, working as individual

LANs. The above networks did not change with the change of the backbone network from Gigabit Ethernet to ATM. Figure 3 shows the IT services network with Gigabit Ethernet without any change while the IT services ATM network includes an ATM switch followed by an ATM-to-Token Ring router to serve the purpose of an ATM LANE set-up.

Similarly the Engineering network (figure 4) and Marketing network (Figure 5) have included an ATM-to-Ethernet router. The voice and video sources and destination devices are also included as the testing of the backbones with regard to these applications occurred from the Engineering network to the Marketing network. An ATM LANE Service server is seen in the Engineering network and this server is needed to provide the ATM backbone network with an ATM LANE service.

After the topologies have been put into place, they all needed to be linked together with their respective link types. This included Ethernet 100BaseT links from the R&D network to Engineering and from Marketing to Sales and Advertising. ATM OC24 links were placed between Engineering, Marketing and IT for the ATM network and 1000BaseX links were placed between these networks for the Gigabit Ethernet network. Marketing to Sales and Advertising. ATM OC24 links were placed between Engineering, Marketing and IT for the ATM network and 1000BaseX links were placed between these networks for the Gigabit Ethernet network.

By making use of the Application Configuration attributes, we defined a set of applications for running on the backbone networks. Instead of choosing and configuring each application individually, we chose all the applications to be supported. By making use of the Profile Definition attributes we are able to choose a number of Profile users in the networks. Each different profile supports a number of different applications. In the simulation environment, we have supported four profiles, namely: Researcher, Engineer, Voice user and Video user as shown in figure 6.

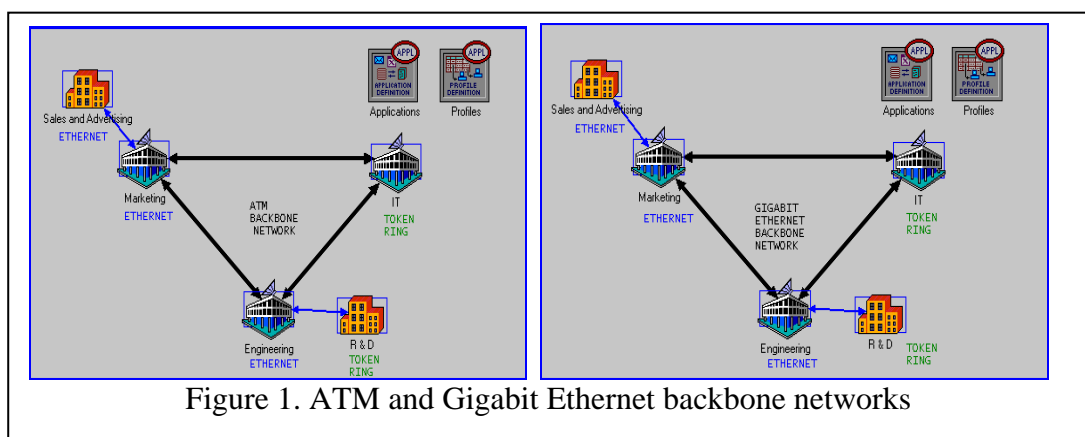

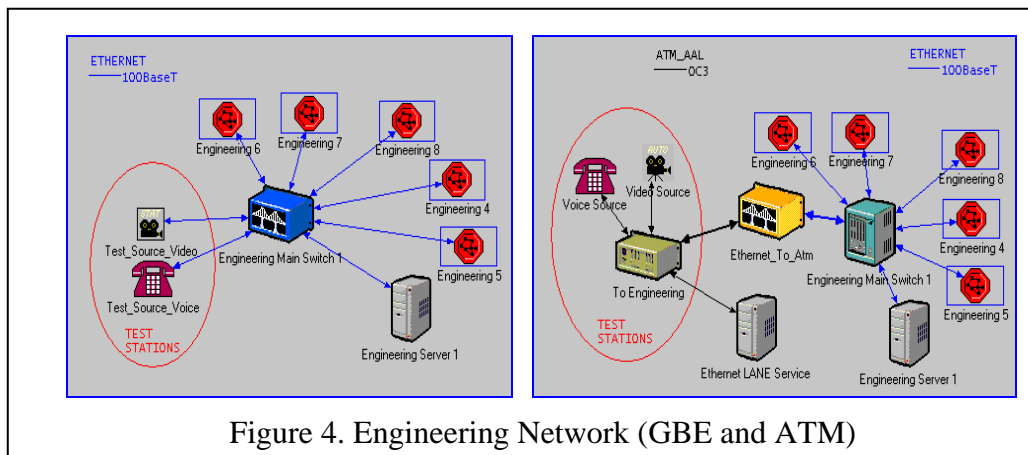
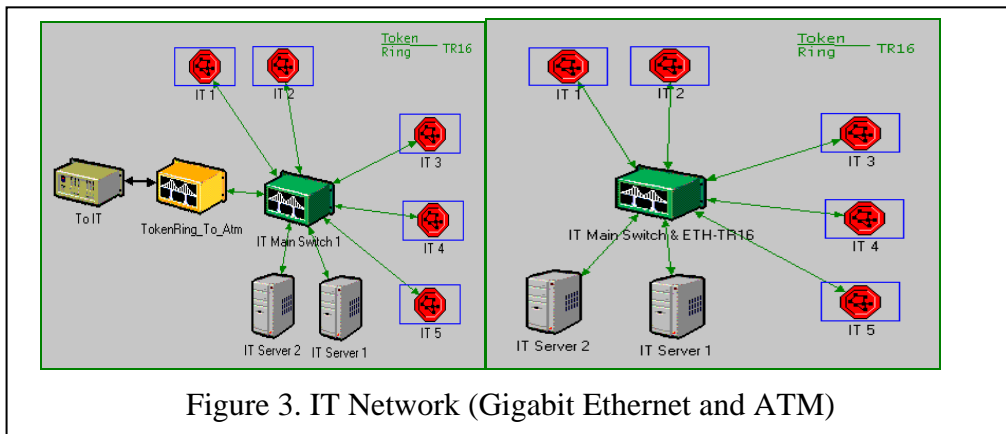
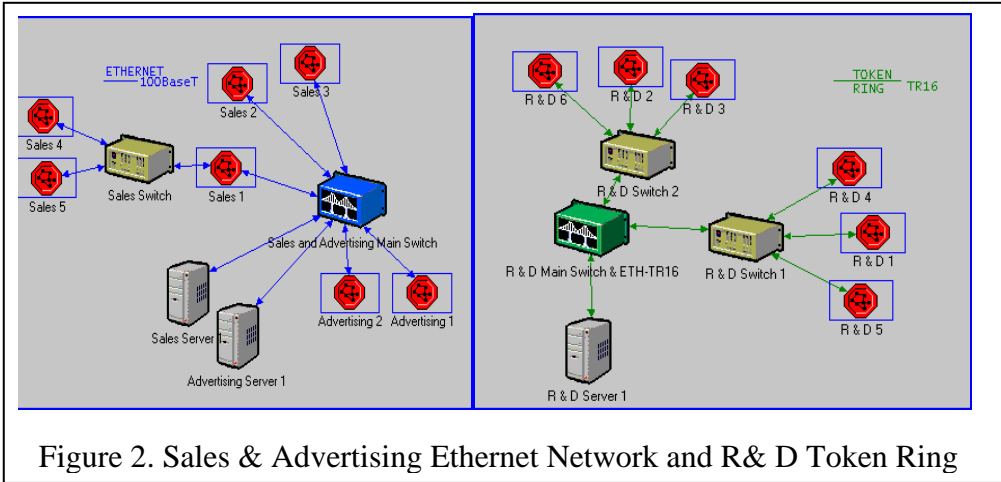

The Engineer and the Researcher were predefined profiles, but the Video and Voice users were customised to suit the needs of the comparison between the ATM and

Gigabit networks. To compare the two backbone networks, the simulation was configured to gather the time related parameter values as shown in table 1.

Table 1. Statistics for simulation results

Video Conferencing	Packet end-to-end Delay
Voice	Packet end-to-end Delay and Packet end-to-end Delay Variation (Jitter)

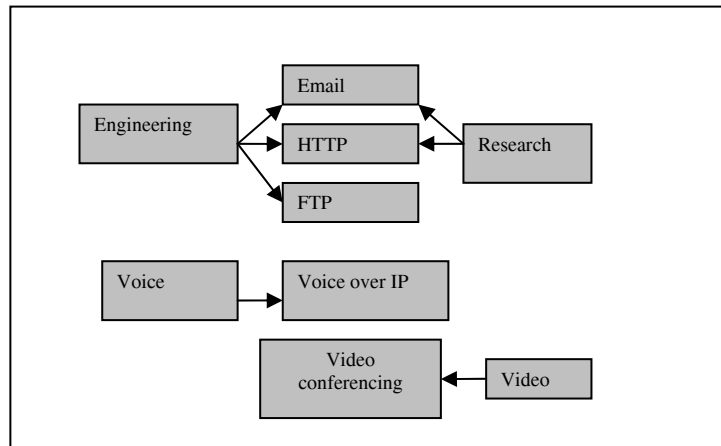

Figure6. Various Profiles with their respective applications

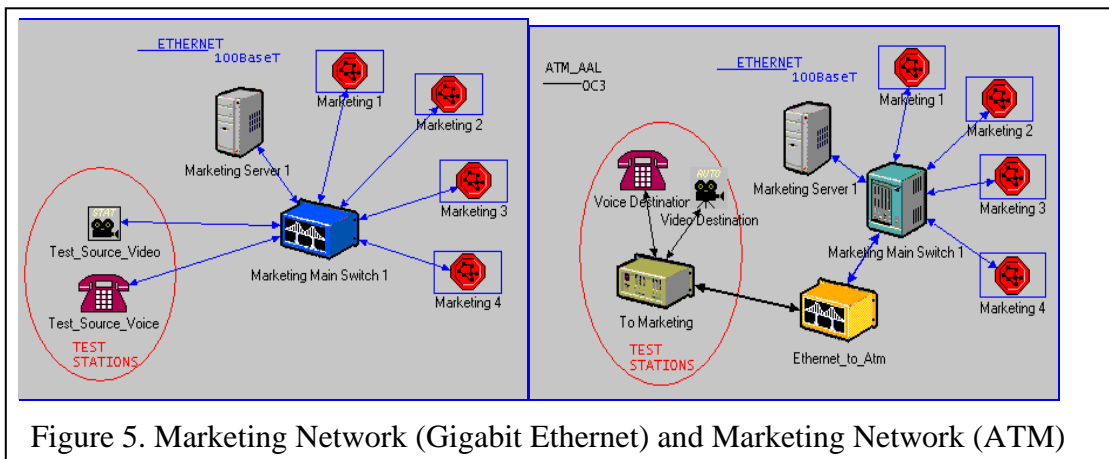

Figure 5. Marketing Network (Gigabit Ethernet) and Marketing Network (ATM)

Table4. Generated Traffic for ATM (Gigabit Ethernet) voice Conferencing

Statistic	Average	Maximum	Minimum
Traffic Received (bytes/sec)	613 (627)	8,416 (10,261)	0
Traffic Sent (bytes/sec)	613(627)	8,416 (10,261)	0

Table5. Gigabit Ethernet and ATM Voice Conferencing

Statistics Voice Conferencing Packet End-to-End Delay (delay variation) (microsec)			
	Average	Maximum	Minimum
Gigabit Ethernet	435 (0.0004)	460 (0.0010)	432 (0.0)
ATM	5.12 (5.87)	5.53 (6.90)	4.96 (5.07)

Finally the two networks were simulated setting a configuration time of 5 minutes. After simulation, if errorless, the results were brought up and a comparison between the two networks was made. The results are presented and discussed in the following section.

### 3 Results and Discussion

The traffic that was generated for each scenario was almost exactly the same. Most of the important statistics are given in tabular form with only the key response graphs shown for visual clarification. Results were collected for both the ATM and Gigabit scenarios with regard to video and voice Conferencing traffic. Figure 7 shows the average packet end-to-end delay times while table 2 shows the amount of video conferencing traffic that was sent for the ATM and the Gigabit Ethernet scenarios and table 3 shows detail of the delay parameter.

It can be seen from the results above that Gigabit Ethernet outperforms the ATM network by almost a tenth. Although the performance of the ATM network is still very good, it does not keep up with the Gigabit Ethernet's small delay time.

To study the performance for voice conferencing, results were collected for both the ATM and Gigabit scenarios with regard to Voice traffic. Table 4 shows the Generated Traffic for ATM (Gigabit Ethernet) voice conferencing supported by the graphs of

figure 8 while table 5 shows the Gigabit Ethernet and ATM voice conferencing statistics with the supporting evidence shown in figure 9.

Table2. Generated Traffic for ATM and Gigabit Ethernet Video Conferencing

Statistic	Average	Maximum	Minimum
Traffic Received (bytes/sec)	17,280	345,600	0
Traffic Sent (bytes/sec)	17,280	345,600	0

Table3. Gigabit Ethernet and ATM Video Conferencing Statistics

Packet End-to-End Delay (sec)			
	Average	Maximum	Minimum
Gigabit Ethernet	0.00334	0.00336	0.00322
ATM	0.0200	0.0200	0.0200

From the figures and tables above we are able to see that the traffic sent was exactly the same as the traffic received for both the gigabit Ethernet and ATM scenarios. However, Gigabit Ethernet has once again outperformed ATM by approximately a tenth with regard to average packet end-to-end delay. With regard to the average packet end-to-end delay variation there seems to be no gigabit Ethernet variation, but the ATM delay does vary slightly thus leading us to the conclusion that Gigabit Ethernet can carry voice traffic with better response times than that of ATM.

## 4 Conclusions

Not long ago, one might have chosen asynchronous transfer mode (ATM) over Ethernet or Fast Ethernet because it was faster, more scalable and offered a higher quality of service. Then along came Gigabit Ethernet, with a full array of standards for Category 5 copper wire, quality of service, virtual LAN support and significantly lower cost. There is sufficient evidence from the results to conclude that Gigabit Ethernet has been able to perform the same and in most cases better than ATM. The fact that we have not been able to make use of ATMs complete range of services, especially that of quality of service (QoS) provisions, leads a whole new area to be investigated. In our ATM backbone network, we have limited its functionality by hiding certain key features away from emulated legacy LANs. Although Gigabit Ethernet has proven itself to be a better backbone than ATM, it cannot be stressed enough that the full capability of ATM has not been utilised. Circuit-switched ATM is a strong and stable technology that manages IP voice and video messaging particularly well, and it will continue to be useful for specialized applications for years to come. For most organizations, Gigabit Ethernet seems to be the way to go as it provides the same and in most cases better performance than ATM as a backbone network, even in networks that require the transmission of delay sensitive traffic such as video and voice.

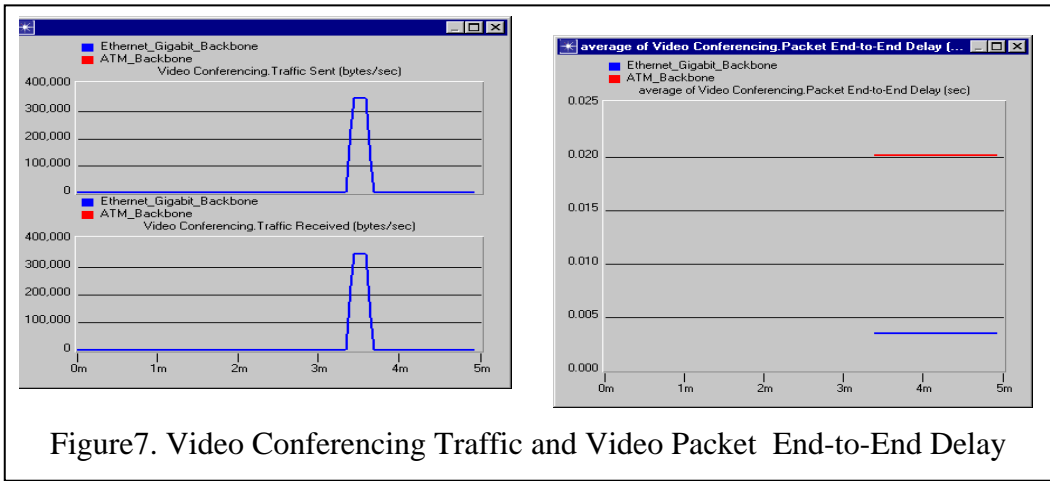

Figure7. Video Conferencing Traffic and Video Packet End-to-End Delay

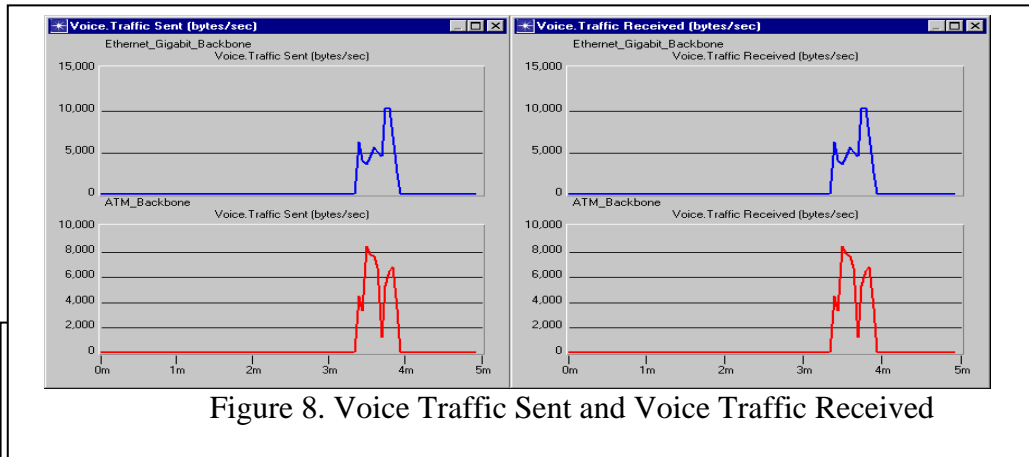

Figure 8. Voice Traffic Sent and Voice Traffic Received

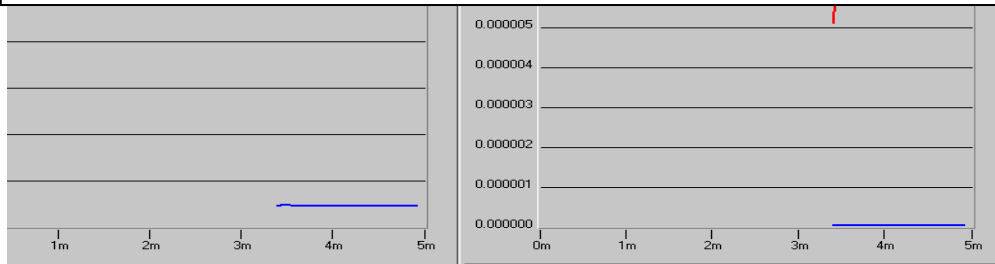

Figure 9. Voice Packet End-to-End Delay and Voice Packet Delay Variation

**References**

Bing Z., Atiquzzaman, M. *Traffic management of multimedia over ATM networks*, IEEE Communications Magazine, Volume: 37, Issue:1, Jan.1999, Pages:33 – 38

Alam, M. F., Atiquzzaman M., Karim, M.A., *Effects of Source Traffic Shaping on MPEG Video Transmission over Next Generation IP Networks*, Eight International



Conference on Computer Communications and Networks, Proceedings., 11-13, Oct.1999 , Pages:514 – 519

Sriram K., Wang, Y.T., *Voice over ATM Using AAL2 and Bit Dropping: Performance and Call Admission Control*, *IEEE Journal on Selected Areas in Communications*, Vol. 17, No. 1, January 1999

Willebeek-LeMair, M. H. and Shae Z.Y., *Videoconferencing over Packet-Based Networks*. *IEEE Journal on Selected Areas in Communications*, 15(6):1101 – 1114, August 1997.

Pazos, C.M.; Kotelba, M.R.; Malis, A.G.; *Real-time multimedia over ATM: RMOA*, *Communications Magazine, IEEE* , Volume: 38, Issue:4, April 2000,Pages:82 – 87

Frazier, H.; Johnson, H., *Gigabit Ethernet: from 100 to 1000Mbps* *Internet Computing*, *IEEE*, Vol:3, Issue:1, Jan.-Feb.1999, Pages:24 – 31

*Hurwitz, J., Feng, W.-C.; End-to-end performance of 10-gigabit Ethernet on commodity systems*, *IEEE Micro*, Volume: 24 , Issue: 1 , Jan.-Feb. 2004 Pages:10–22

*Vaughan-Nichols, S.J.; Will 10-Gigabit Ethernet have a bright future?*, *Computer*, Volume:35, Issue: 6, June 2002 , Pages: 22 – 24

OPNET Modeller, <http://www.opnet.com/>

