

Copyright is owned by the Author of the thesis. Permission is given for a copy to be downloaded by an individual for the purpose of research and private study only. The thesis may not be reproduced elsewhere without the permission of the Author.

ANALYSIS OF FARMER COGNITIVE STRUCTURES
WITH RESPECT TO HIGH FECUNDITY SHEEP
MANAGEMENT SYSTEMS

L. S. SAUNDERS

August 1987

A thesis presented in partial fulfilment
of the requirements for the degree of
Master of Agricultural Science in
Agricultural Economics and
Farm Management at
Massey University

Massey University Library

Thesis Copyright Form

Title of thesis: Analysis of Farmer Cognitive Structures with respect to High Fecundity Sheep Management Systems.

- (1) (a) I give permission for my thesis to be made available to readers in the Massey University Library under conditions determined by the Librarian.
- ~~(b)~~ I do not wish my thesis to be made available to readers without my written consent for _____ months.
- (2) ~~(a)~~ I agree that my thesis, or a copy, may be sent to another institution under conditions determined by the Librarian.
- (b) I do not wish my thesis, or a copy, to be sent to another institution without my written consent for 3 months.
- (3) (a) I agree that my thesis may be copied for Library use.
- ~~(b)~~ I do not wish my thesis to be copied for Library use for _____ months.

Signed L Saunders.
Date 15 Dec 1987.

The copyright of this thesis belongs to the author. Readers must sign their name in the space below to show that they recognise this. They are asked to add their permanent address.

NAME AND ADDRESS

DATE

ABSTRACT

The object of the research presented in this thesis is to evaluate three multivariate techniques for representing and analysing farmer cognitive structures. The context involves representation of farmer belief and attitude relationships relative to their overall attitude towards high fecundity sheep production systems. Modelling of behavioural determinants positions this research within the soft component of management and is aimed at moving from the 'art' to the 'science' (as defined by Nix, 1979) of soft systems management research.

Reviews of high fecundity production systems are presented such that the 'act' of high fecundity was defined as: "to maximise the weight of lamb weaned within flocks with a potential of 140% Lambs Born per Ewe Weaned."

The Fishbein and Ajzen (1979) model of reasoned action is extended to incorporate the differentiation of input and outcome concepts. Galileo Methodology (Woelfel et al, 1977), involving a system of interview methods and questionnaires in association with a Metric Multidimensional Scaling program, was used to measure the belief and attitude relationships and then spatially represent the cognitive structures of a sample of Western Hawkes Bay Farmers and a group of Experts.

The extension objective of this research is to identify differing cognitive structures between groups of farmers with and without experience of the act relative to an Expert group. Increasing levels of farmer experience resulted in stronger overall attitudes to the act.

Multiple Discriminant Analysis and Metric Multidimensional Scaling incorporating Procrustes rotations of spatial representations, identified the concepts of Maintaining Ewe Body Condition during Pregnancy, Reduced Stocking Rates and Multiple Lamb Survival as having the least degree of alignment. The

cognitive structures of the Experts and Inexperienced farmers are in closest alignment, contrary to the predicted result from the experiential learning theories discussed. It is hypothesised that individuals with similar cognitive structures may have differing overall attitudes. The Management of the extension process is discussed relative to this hypothesis, as the extensionist may need to assist managers to learn the 'right' relationships not just assist managers to learn, if the efficiency of learning processes are to be enhanced.

Extension messages for each group, derived by Linear Aggregation theory (Woelfel and Fink, 1980), relating the act to the concepts of Multiple Lamb Survival, Later Lambing, Multiple Lamb Growth Rates and Summer Pasture Control are predicted to strengthen the overall attitudes towards the act for both farmer groups.

A multiple regression version of the Fishbein and Ajzen model is presented as another means of predicting change in the overall attitude as a result of belief and attitude changes.

The conclusion from this study is that Multiple Discriminant Analysis and Multidimensional Scaling offer significant opportunities to develop soft systems research in a descriptive sense, provided issues regarding measurement adequacy are resolved.

The potential of multivariate analysis for predicting cognitive change appears to exist but requires validation through time series data analysis, and resolution of the behaviour determinants and how these change through time.

TABLE OF CONTENTS

CONTENTS	PAGE
Title Page	
Abstract	i
Table of Contents	iii
List of Tables	ix
List of Figures	xii
Acknowledgements	xvi
CHAPTER ONE: INTRODUCTION	1
1.0.0 Introduction	1
1.1.0 High Fecundity	10
CHAPTER TWO: SOFT SYSTEMS	11
2.0.0 Introduction	11
2.1.0 Behavioural Models	13
2.1.1 Attitude - Black Box	13
2.1.2 Fishbein and Ajzen Model of Reasoned Action	13
2.1.3 'Galileo' Model of Behaviour	19
2.1.4 Attitude - Behaviour Link	23
2.2.0 Soft Components Dynamics	25
2.2.1 Learning and Knowledge	25
2.2.2 Learning Theories	26
2.2.3 Personal Construct Theory (P.C.T.)	27
2.2.4 Adult Learning	30
2.2.5 Learning - A Farm Management Extension Research Context	32
2.3.0 Summary	36
CHAPTER THREE: ISSUES OF SOFT SYSTEM MEASUREMENT	39
3.0.0 Introduction	39
3.1.0 Measurement Objectives	39
3.2.0 Measurement of Behavioural Determinants	40
3.2.1 Attitude as a Black Box	40

	PAGE	
3.2.2	Fishbein and Ajzen Model	41
3.2.3	Galileo Model of Behaviour	42
3.3.0	Summary	44
3.4.0	Measurement Systems	44
3.4.1	Introduction	44
3.4.2	Reference Concept Elicitation	45
3.4.3	Measurement and Measurement Procedures	49
3.4.4	Presentation and Ordering of the Measurement Task	53
3.5.0	Summary	56
CHAPTER FOUR:	GALILEO METHODOLOGY AND MULTIVARIATE ANALYSIS	58
4.0.0	Introduction	58
4.1.0	Galileo Methodology	58
4.1.1	Procedures	59
4.2.0	Multidimensional Scaling (MDS)	61
4.2.1	Metric - Nonmetric MDS	61
4.2.2.0	Metric MDS	62
4.2.2.1	Distance Models	62
4.2.2.2	Spatial Models	63
4.3.0	Galileo Multidimensional Scaling	64
4.3.1	Spatial Model	64
4.3.2	Distance Model	65
4.3.3	Further Analysis	66
4.4.0	Galileo Methodology: Summary	72
4.5.0	Multiple Discriminant Analysis (M.D.A.)	73
4.5.1	Graphical Representation	75
4.6.0	Multiple Regression	75
4.7.0	Summary	76
CHAPTER FIVE:	STUDY AREA AND RESPONDENTS	78
5.0.0	Introduction	78
5.1.0	Study Area	78
5.2.0	Class Five Properties	80
5.3.0	Performance Survey	81
5.3.1	Survey Results	83
5.4.0	Summary	89

	PAGE
CHAPTER SIX: HIGH FECUNDITY PRODUCTION SYSTEMS	90
6.0.0 Introduction	90
6.1.0 High Fecundity	90
6.2.0 Multiple Lamb Survival	92
6.2.1 Birthweight	92
6.2.2 Starvation - Exposure Deaths	94
6.2.3 Nutritional Influences on Birthweights	95
6.2.4 Survival Summary	97
6.3.0 Lamb Growth	98
6.3.1 Milk Yield	98
6.3.2 Nutritional Influences on Milk Yield	99
6.3.3 Sex of Lamb	101
6.3.4 Lamb Growth Summary	101
6.4.0 Feed Demand Implications	103
6.5.0 Summary	104
CHAPTER SEVEN: DATA COLLECTION	106
7.0.0 Introduction	106
7.1.0 Reference Concept Elicitation	106
7.1.1 Elicitation Interviews	106
7.1.2 Trial Interview	107
7.1.3 Study Interviews	108
7.1.4 Interview Results	109
7.1.5 Concept Weightings	110
7.1.6 Reference Concepts	113
7.2.0 Trial Paired Comparison Surveys	115
7.3.0 Paired Comparison Survey	119
7.3.1 Criterion Pair	119
7.3.2 Administration	120
7.3.3 Paired Comparison Results	121
7.3.4 Respondent Comments	122
7.4.0 Data Formatting and Analysis	123
7.5.0 Respondent Characteristics	123
7.6.0 Galileo Analysis	129
7.7.0 Summary	130

	PAGE
CHAPTER EIGHT: RESULTS	132
8.0.0 Introduction	132
8.1.0 Belief and Attitude Measures	132
8.2.0 Overall Attitudes	133
8.3.0 Principal Belief Measures	133
8.4.0 Evaluative Attitude Measures	135
8.5.0 Discussion of Principal Belief; Evaluative Attitude Measures	135
8.5.1 Expert Group	135
8.5.2 Hilamb Experience Group of Farmers	138
8.5.3 Hilamb Inexperience Group of Farmers	139
8.5.4 Intergroup Comparisons	140
8.6.0 Peripheral Beliefs	142
8.6.1 Reduced Stocking Rate	142
8.6.2 Multiple Lamb Survival	145
8.6.3 Maintaining Ewe Body Condition during Pregnancy	147
8.6.4 Higher Birthweights of Multiple Lambs	149
8.6.5 Higher Growth Rates of Multiple Lambs	150
8.6.6 Later Lambing - High Lactation Feeding	151
8.6.7 Controlled Set Stocking	152
8.7.0 Spatial Representation	153
8.7.1 Expert Group	153
8.7.2 Farmer Group	155
8.7.3 Experienced Farmer Group	158
8.7.4 Inexperienced Farmer Group	160
8.8.0 Summary	161
CHAPTER NINE: COMPARATIVE ANALYSIS	163
9.0.0 Introduction	163
9.1.0 Procrustes Comparative Analysis	163
9.1.1 Comparison of the Experienced and Inexperienced Group	164
9.1.2 Procrustes Rotations of the Expert Group with the Experienced and Inexperienced Groups	168
9.2.0 Multiple Discriminant Analysis	171

	PAGE	
9.2.1	Principal Belief Discriminant Functions	172
9.2.2	Evaluative Attitude Discriminant Functions	177
9.2.3	Overall Attitude Index Discriminant Functions	181
9.3.0	Summary	187
CHAPTER TEN:	EXTENSION MESSAGES	189
10.0.0	Introduction	189
10.1.0	Galileo Extension 'Message' Generation	189
10.1.1	Expert Group	192
10.1.2	Farmer Group	192
10.1.3	Experienced Farmers	194
10.1.4	Inexperienced Farmers	195
10.2.0	Summary - Discussion of Galileo Messages	195
10.3.0	Multiple Regression Model	196
10.4.0	Summary	198
CHAPTER ELEVEN:	CONCLUSIONS	200
11.0.0	Introduction	200
11.1.0	Galileo Model	201
11.1.1	Measurement Task	201
11.2.0	Belief - Attitude Relationships	204
11.2.1	Between Group Comparisons	206
11.3.0	Farm Management Extension	209
APPENDICES		
1.0	Young and Householder Theorems	212
1.1	Eigenvalues (Eigenroots, Characteristic Roots) etc	215
2.0	Schema of High Fecundity Management Concepts	218

	PAGE
3.0 Pilot Pair Comparison Instructions	219
4.0 Study Pair Comparison Instructions and Reference Concept Definitions	220
5.0 Co-ordinate Sets for the Cognitive Structures obtained from the Expert, Farmer, Experienced and Inexperienced Groups	224
6.0 Procrustes Rotation of the Experienced and Inexperienced Groups	226
7.0 Procrustes Rotation of the Experienced and Expert Groups	229
8.0 Procrustes Rotation Co-ordinate Sets Inexperienced and Expert Groups	231
BIBLIOGRAPHY	233

LIST OF TABLES

TABLE		PAGE
5:1	Monthly Pasture Growth Rates (kg DM/ha) and Total Production (kgDM/ha)	88
5:2	Performance Survey Results	84
5:3	Comparative Lambing Performance Levels	86
7:1	Trial Reference Concepts	114
7:2	Study Reference Concepts	117
7:3	HiLamb Experienced Versus Inexperienced Demographics	124
7:4	Educational Qualifications	127
7:5	Information and Advice Sources	128
8:1	Mean Principal Belief Measures for the Expert, Farmer and Experienced and Inexperienced Groups	134
8:2	Evaluative Attitude for the Expert, Farmer, Experienced and Inexperienced Groups	135
8:3	Reduced Stocking Rate peripheral beliefs for the Expert; Farmer; Experienced and Inexperienced Groups	143
8:4	Peripheral Belief Measures involving Multiple Lamb Survival	145

		PAGE
8:5	Peripheral Belief Measures involving Maintaining Ewe Body Condition during Pregnancy	147
8:6	Peripheral Belief Measures involving Higher Birthweights of Multiple Lambs	149
8:7	Peripheral Beliefs associated with Higher Growth Rates of Multiple Lambs	150
8:8	Peripheral Beliefs associated with the Concepts of Later Lambing - High Lactation Feeding and Controlled Set Stocking	152
9:1	Distances separating reference concepts in the Cognitive Structures of the Experienced and Inexperienced Groups (All 10 Dimensions)	166
9:2	Analysis of Concept Separations between the Experienced and Inexperienced Farmer Groups (5 Dimensions only)	168
9:3	Concept Separations and the Associated Correlations for the Common Rotated Space involving the Experienced and Expert Groups (5 Dimensions only)	169
9:4	Concept Separations and the Associated Correlations for the Common Rotated Space involving the Inexperienced and Expert Groups (5 Dimensions only)	170
9:5	Discriminating Power Individual Principal Beliefs	172

		PAGE
9:6	Canonical Discriminant Functions based upon Principal Beliefs	173
9:7	Mean Discriminant Scores of the Principal Beliefs for the Expert, Experienced and Inexperienced Groups	175
9:8	Reference Concept Discriminating Power within the Evaluative Attitude Dataset	177
9:9	Canonical Discriminant Functions for Evaluative Attitudes	178
9:10	Mean Discriminant Scores for Attitude Measures for the Expert, Experienced and Inexperienced Groups	179
9:11	Reference Concept Discriminating Power within the Overall Attitude Index	182
9:12	Canonical Discriminant Functions for Overall Attitude Index	183
9:13	Mean Discriminant Scores for Overall Attitude Index measures for the Expert, Experienced and Inexperienced Groups	184
9:14	Pooled within Groups Correlations between Canonical Discriminant Functions and Discriminating Variables	185
10:1	Three Optimal Messages for the Expert, Farmer, Experienced and Inexperienced Groups as derived from Galileo (TM) A.M.G.	191
10:2	Beta Weights of the Concepts with variance Pooled Across Groups	197

LIST OF FIGURES

FIGURE		PAGE
2:1	Diagrammatic Representation of the Fishbein and Ajzen Model	14
2:2a	Fishbein and Ajzen Model	18
2:2b	Management version Fishbein and Ajzen Model	18
2:3	Diagrammatic Representation of the Conceptual Behavioural Model utilised by Galileo Theory	23
2:4	Kellian Approach to Self Directed Learning	31
2:5	Resource Model of Extension	34
4:1	Three Points on a Rhiemann Plane	66
4:2	Hypothetical Representation of MDS Space	68
4:3	Hypothetical Representation of a MDS Space - Compound Messages	69
5:1	Study Area	79
5:2	Distribution of Lambing Performance and Location of Study Sample throughout the Study Area	85
6:1	Impact of Birthweight of Lambs on the number of Lambs Weaned per Lambs Born	93

		PAGE
6:2	The Effects of Undernutrition during the Second and Third Months of Pregnancy on the Size of Placentae and Foetuses at Day 90 of Gestation	96
6:3	Feed Demand Profiles for 2000 Ewe Flock plus Replacements at Two Levels of Fecundity	102
7:1	Comparison of Initial Survey Respondents and Paired Comparison Respondents, based upon their Average Lambing Percentage	126
8:1	Evaluative Attitude - Principal Belief Measures for the Expert Group	137
8:2	Principal Belief - Evaluative Attitude Measures for the Experienced Group	138
8:3	Principal Belief - Evaluative Attitude Measures for the Inexperienced Group	140
8:4	Intergroup Comparison between the Expert, Experienced and Inexperienced Groups based on the Mean Principal Belief, Evaluative Attitude Measures with respect to Reduced Stocking Rates	141
8:5	Intergroup comparison between the Expert, Experienced and Inexperienced Groups based on the Mean Principal Belief, Evaluative Attitude Measures with respect to Ewe Body Condition in Pregnancy	141

		PAGE
8:6	Intergroup comparisons between the Expert, Experienced and Inexperienced Groups based on the Mean Principal Belief, Evaluative Attitude Measures with respect to Multiple Lamb Survival	141
8:7	Intergroup comparisons between the Expert, Experienced and Inexperienced Groups based on the Mean Principal Belief, Evaluative Attitude Measures with respect to Multiple Lamb Birthweight	141
8:8	Intergroup comparisons between the Expert, Experienced and Inexperienced Groups based on the Mean Principal Belief, Evaluative Attitude Measures with respect to Multiple Lamb Growth Rates	141a
8:9	Intergroup comparisons between the Expert, Experienced and Inexperienced Groups based on the Mean Principal Belief, Evaluative Attitude Measures with respect to Controlled Set Stocking	141a
8:10	Intergroup comparisons between the Expert, Experienced and Inexperienced Groups based on the Mean Principal Belief, Evaluative Attitude Measures with respect to Later Lambing Dates	141a
8:11	Intergroup comparisons between the Expert, Experienced and Inexperienced Groups based on the Mean Principal Belief, Evaluative Attitude Measures with respect to Summer Pasture Control	141a

		PAGE
8:12	Spatial Representation of Expert Cognitive Structure	154
8:13	Spatial Representation of Farmer Cognitive Structure	157
8:14	Spatial Representation of Experienced Farmers Cognitive Structure	159
8:15	Cognitive Structure of the Inexperienced Farmer Group	161
9:1	Two Dimensional Representation of Concepts located Within Two Co-ordinate Sets based upon Common Dimensions	165
9:2	Multiple Discriminant Analysis based on the Principal Belief Measures for the Expert, Experienced and Inexperienced Groups	176
9:3	Multiple Discriminant Analysis based on the Evaluative Attitude Measures for the Expert, Experienced and Inexperienced Groups	180
9:4	Multiple Discriminant Analysis based upon the Overall Attitude Index for the Expert, Experienced and Inexperienced Groups	186
10:1	Theoretical Representation of the Simple Message - Later Lambing is essential to High Fecundity Sheep Management	190

ACKNOWLEDGEMENTS

The research reported within this thesis grew from the stimulation and support from several people. In particular the input of Professor R. J. Townsley for his academic stimulation and standards that encouraged me to challenge and enhance my knowledge is most willingly acknowledged - surely this is the aim of post graduate study.

To Mr John Cary of Melbourne University who took me through the vagueries of the computer programmes used in this study and for his direction through the difficulties encountered. John my thanks to your wife and family also for their hospitality and humour.

The farmers who took the time and inconvenience to discuss their views with me are recognised in that without their efforts there would be no research.

The many individuals I encountered at Massey were a highlight - Anton on the squash courts, Smithy and his Frog, the many cricketers and all the others.

To my wife - Raewyn considerable frustration and sacrifices that you in particular made can never be repaid, but I'll try.

Finally to my parents who always encouraged academic enhancement, especially my father who was unable to see the end result of my Masterate, I can only hope it approaches the excellent standards of his own workmanship.

All omissions and errors are the sole responsibility of the author.

CHAPTER ONE : INTRODUCTION

1.0.0 INTRODUCTION

In this chapter the general concepts management are posited within a farm management context. The distinction between the discipline and practice of farm management is made, and the management process discussed within an extended learning - education framework. Farm management research and extension goals and objectives are discussed, with the decision making goals of farm management research identified as one of the features differentiating this activity from the learning process goals of extension.

The evolution of farm management research is discussed in terms of moving from a data collection and analysis role to one of understanding behaviour and behaviour determinants, implying a close relationship between farm management research and extension activity.

The concluding section of chapter 1 places the study within a static behaviour modelling framework, with the purpose of evaluating some multivariate analysis methodologies as means of quantifying and spatially representing an extended interpretation of the Fishbein and Ajzen model, in the context of a high fecundity sheep production system.

The Doubleday dictionary (1975) defines management as: the act, art, or manner of managing; controlling, conducting the skilful use of means to accomplish a purpose; managers or directors collectively.

Management is the act of controlling the execution process for a given policy, where the task of management is seen as being distinct from resource ownership and the manual execution of activities. The owner/operator structure of farming combines all three roles into one and involves the family unit with these roles,

increasing the complexity of the farm management task. Farm Management is made considerably more difficult where the degree of managerial control is limited by the inherent variability of biological production systems. This situation is characteristic of New Zealand pastoral farming conditions. These aspects have led to farm management being defined as an 'art' (Nix, 1979), which reflects the largely subjective, qualitative basis of farm management processes.

Farm management can be discussed from several perspectives. Wright (undated) presented five different perspectives from which to view farm management, viz:

- 1) The farmer - who formulates goals, makes decisions and provides some or all of the labour.
- 2) The employed manager - as for 1), but may not be involved in the formulation of goals.
- 3) Advisor or consultant - providing information and services to assist farmers in decision making.
- 4) Researchers - where management research concentrates on the processing of information rather than the creation of information.
- 5) Educators - whose role encompasses all aspects of 1) - 4). The perspective of Advisors, Researchers and Educators comprise the discipline of farm management, which consists of the body of knowledge and techniques that have been developed to assist managers to manage their production systems, relative to their goals.

The farmer's and the paid manager's perspectives combine to form the practice of farm management which Dillon (1980) defined as "The process by which resources or situations are manipulated by the farm manager in trying with less than full information to achieve

his goals." The discipline cannot be viewed as being totally independent of the practice of farm management, as a large proportion of the body of knowledge making up the discipline resides with those practising farm management.

Dewey (cited in Hodgson (1971) developed the concept of the management process, which Bradford and Johnstone (1957) formally introduced into the farm management discipline. The problem solving or decision making framework of the management process as presented by Hodgson (1971) retains a central role in the practice of farm management, as without the tasks of deciding, there would be no need to manage, firstly with respect to goal formulation, as without goals any outcome would suffice and latterly as to whether a problem exists and if so, what action is required.

The practice of farm management and the related management process (problem identification and solving framework) offers managers the opportunity to learn, in that an action (decision) is made with an expected result relative to a goal. The opportunity to learn exists, to the extent that observed outcomes may or may not vary from the predicted outcomes. Learning is considered to be the possession of knowledge, with the process of learning defined as a change in the relative state of knowledge compared to the 'real' world knowledge. Knowledge can be viewed as the proportion of a manager's perception that aligns with the 'real' world system.

Loftus and Cary (1980) presented an extended management process framework within an educational/learning framework, covering three broad categories, viz:

- A) Having facts, data and understanding.
 - 1) Command of basic facts of situation - resource availability; costs and prices, knowing agents etc.
 - 2) Relevant technical understanding of technology input/output, market legislation, customs etc, relevant

to the production and management system.

- B) Having the qualities and skills of problem solving and the qualities that make problem solving relevant to situations.
- 3) Sensitivity to events and situations, skills of perception, data gathering, problem recognition.
 - 4) Analytical, problem solving and decision making skills. (As per the decision making framework (Hodgson, *ibid*).)
 - 5) Social skills and abilities - skills and qualities appropriate to plans, decisions concerned with working with other people, e.g. family, neighbours, employees, professionals.
 - 6) Ability to maintain sensitivity under pressure and to handle stress. Under stress a manager needs to remain sensitive to threatening data or situations without over-reacting or becoming defensive.
 - 7) Inclination to respond purposefully, reflecting the goals and aims which are sought. Also qualities which determine the extent to which he can clarify and resolve which goals are important.
- C) Qualities which influence the market processes involved in management, reflecting qualities which make the manager better or worse at acquiring and using the specific qualities and skills in 1) - 7) above.
- 8) Creativity - imagination and the ability to produce ideas and new approaches.
 - 9) Balanced thinking and learning skills. Abstract as well as concrete thinking skills. The ability to relate in practical thinking, to reflect and actively experiment,

the ability to manage his learning processes and to recognise the strengths and weaknesses of his own skills in the practice of farm management.

In the context of this study, the educational - learning framework is utilised as representing the farm management process due to the emphasis in this research on the human component of the management system.

Farm management extension is "... a service which assists farm people through educational procedures ..." Farquhar (1962), whereas farm management research aims at assisting managers to manage more effectively by the systematic enquiry into the process and practice of farm management.

Farm management research is involved in replacing the 'art' of the farm management discipline with the 'science' of farm management in an attempt to improve managements' goal attainment, by the collecting and analysing quantitative, objective data on their production and management systems and hence to assist managers with their decision making and learning processes.

Farm management research has two main objectives. The positive objective is to understand the basis of farmer's behaviour, in order to predict their behaviour and the likely system outcomes for the development and evaluation of agricultural policy. The normative objective is to understand both the decision and learning processes of farmers and thereby assist farmers to manage their production and management systems more effectively. Within a systems context the normative objective can be viewed as achieving the right decision or behaviour at the right time whilst the positive objective is viewed to be the ability to predict the behaviour in advance, in effect both objectives require an understanding of the determinants of behaviour.

Over time, the discipline of farm management has developed a wide range of knowledge and techniques to assist in the achievement of research objectives. Within a farm management research context, the early systematic enquiries of Hays (- cited in Jensen, 1977) (cost - route studies), Mosher (- cited in Jensen, 1977) (cost - accounts) and Warren (1912)) (farm surveys) produced objective input/output data in a positive sense, and also in a normative sense, with the purpose of allowing managers to compare their system output against a range of production systems output and hence make better decisions. This research became prescriptive in the sense that model farm systems were presented as being optimal systems.

The initial data collection phase of farm management research was followed by a period during which the principles of Budgeting (Forster, 1946) and Production Economics (Black, 1926) were applied to the data collected, to develop models of the production functions underlying the alternative production systems. The fundamental paradigm during this era was to present managers with optimal resource allocations on a between and within enterprise basis, with the objective of enabling improved management decisions. The principles of budgeting and production economics were then utilised with increasingly complex analytical techniques (e.g. mathematical programming). These were designed as tools to assist managers to view the consequences and sensitivity of alternative input levels and enterprise mixes, with the goal of quantifying the predicted outcomes of alternative decisions. These models were of the form: - this input mix results in this output, and provided no insight as to why the specific outputs actually occurred. Quantitative simulation models were subsequently developed to break down the input/output link into the underlying biological, technical and financial relationships. Simulation also introduced the concept of understanding decision behaviour and learning processes with respect to the sources and the uses of information of managerial problems arising from incomplete information, (Blackie and Dent, 1974).

The incorporation of risk and uncertainty led to the application of probability theory, Bayesian subjective probability, expected profit and utility theory concepts to the farm management decision making problem in an attempt to predict managers' behaviour, given the range of likely production system outcomes, (Nix, 1979).

Farm management research has evolved from the situation in which Warren (1945) viewed each farm "... as an experiment station", where managers and researchers through systematic enquiry can increase their level of knowledge of production systems within the discipline of farm management, to where the researcher can use the manager and his production system as a research entity. The fundamental paradigm has developed from one of optimisation through resource allocation decisions, to one of optimisation through the development of farmer learning and decision making processes.

With increased emphasis on the decision making aspect of the management process, a theoretical model of behaviour - the Fishbein and Ajzen model of reasoned action, which identified the determinants of behaviour as being the perceived belief and attitude relationships and the social or peer group attitude relationships to the action, was proposed by Maughan (1980) as a possible means to gain insight into the information basis of decisions. The Fishbein and Ajzen model represents the end result of a manager's learning process up to that point in time, enabling farm management research to identify the information on which decisions are made and the way in which this information is combined to make decisions. In effect, the combination of information identified disaggregates the components of the utility concepts traditionally utilised to predict behaviour.

Modelling of behaviour has two separate stages. Firstly the determinants of behaviour can be identified within a static or status quo setting, with the objective of understanding the determinants of behaviour (in terms of the concepts used to define the problem situation and their inter-relationships), as perceived by the manager, for a goal oriented action. It is within this

context that this study utilises 'Galileo' Methodology (essentially a multidimensional scaling technique) to quantify and spatially represent the belief and attitude relationships underlying the Fishbein and Ajzen model, i.e. the 'art' of managers' behaviour is being extended into the 'science' of behaviour.

The second stage of behaviour modelling is the dynamic learning aspect of behaviour. Experiential learning was formally stated by Kelly, (1955) in his Personal Construct theory as where man was viewed as a scientist, interacting with his environment, construing (predicting) events, evaluating outcomes and adjusting his "construct system" to cope with the experienced outcomes. Kelly's act of modifying constructs is seen as being analogous to learning (Salmon, 1980), with the manager's construct system equating to the Fishbein and Ajzen belief and attitude structures. The addition of a time dimension to the Fishbein and Ajzen framework should therefore enable the experiential learning process to be monitored.

The objective of farm management research with respect to farmer behaviour dynamics is to assist extension researchers and practitioners to more effectively manage their actions relative to their goals of increasing farmer management skills. One objective of extension intervention is to assist in improving managers' learning processes by aligning managers' perceived beliefs to a set of beliefs representing the current state of knowledge (as perceived by the intervening agents).

Managing extension intervention requires a knowledge of change in the pre- and post intervention states. Initial research (Cronin (1968), McNeil et al (1985) utilised the level of production system output as an indirect measure of the influence of a goal directed intervention (and subsequent learning process). The learning process has been a 'black box' in these studies, (analogous to the early mathematical programming techniques used to investigate the production system in an input/output framework). Although McNeil et al (1985) added subjective evaluations of how managers perceived a specific intervention strategy on a post-study basis only, little

or no understanding of the manager's learning process was achieved. One danger of indirect measures of intervention success when working with a variable production system is that production system output may change due to uncontrolled variables resulting in a positive or negative evaluation.

As a result of the quantitative spatial representation of the belief and attitude relationships by the Galileo Methodology, there exists the potential to evaluate the effectiveness of an intervention strategy in changing a client group's beliefs and attitudes over time. Knowledge of changes in the manager's beliefs and attitudes across groups and time will assist researchers to learn about the manager's learning process. (In Kellian terms, the researcher is interacting with the manager's learning system.) Such information systems can be described as a "Soft System Management Information System."

Galileo methodology potentially offers a soft system management information system capable of objectively monitoring beliefs and attitude structures, fundamental to the Fishbein and Ajzen model of behaviour. In addition, Galileo offers the potential to target specific beliefs, that if changed, will theoretically increase the likelihood of the specific action.

The development of soft system management information systems offers the potential for improved management of extension activity via the targeting of beliefs and attitudes to be changed (to increase the managers' level of knowledge) and evaluation of a range of potential strategies that can be utilised to create the change. That is, a soft systems management information system offers an objective basis for extension managers to learn about the effectiveness or otherwise of various intervention strategies relative to their goals.

This study is set within the context of modelling behaviour, with the objective of providing insight into how managers perceive the belief and attitude relationships of a production system. Specifically, the research attempts to represent how managers

perceive the management of a high fecundity sheep production system and how these beliefs align with an expert group's perceptions of the same system. The overall objective is to explore the potential use of quantifying and spatially representing beliefs and attitudes as a model of behaviour using Galileo multi-dimensional scaling methodology in the context of enhancing the adoption of high fecund sheep production systems.

The secondary objective derives from the author's position within the Economics section of Advisory Services Division of the Ministry of Agriculture and Fisheries. Walker (1984) presented one of the roles of Economics section staff as, "assisting the general advisory staff to achieve their goals through the development of improved on and off-farm management systems." The Galileo methodology is seen as offering insight into the soft component of management systems, complementing the traditional hard system models used for farm management research and development.

1.1.0 High Fecundity

High fecundity is defined for the purpose of this research as being "those flocks with the potential to produce 140% lambs born per ewe mated" (Davis 1985, Owens 1984, Rohloff 1984). At this level of performance, greater than fifty percent of lambs are born as multiples and management strategies should therefore be targeted towards the management of multiples. (Rohloff, 1984).

The objective of successful high fecund management is stated as "to maximise the weight of lamb weaned per ewe, within flocks with a potential lamb drop of 140%."

Within the context of this study, high fecundity management systems are used as a vehicle for evaluating a number of different methodologies for modelling the determinants of farmer behaviour, i.e. representing the belief and attitude constructs held by farmers relative to their overall attitude towards high fecundity production systems.

CHAPTER TWO : SOFT SYSTEMS

2.0.0 INTRODUCTION

In Chapter 1, farm management research was presented as an evolutionary process, expanding from a paradigm of optimisation of objectives through resource allocation decisions, to the optimisation of objectives through learning and the management of the learning processes. Checkland (1979) has called the two components of the above expansion the 'hard' and 'soft' technologies respectively.

Hard systems research seeks to aid decision making to efficiently reach defined objectives utilising physical and financial concepts for the systematic appraisal of alternatives. Within a farm management research context, hard systems research is involved in systems modelling of the technical, biological and financial relationships underlying the production system, i.e. hard in the sense that physical quantities are involved e.g. x kg of ewe liveweight equates to y lambing percent.

Soft systems research seeks to aid decision making by incorporating problem solving principles, involving a manager's perception of the technical, biological and financial relationships and situations, within a holistic view of management. Checkland (1979) claimed that the soft technologies "... are concerned with the 'problems of management', in the broad sense that human activity involves planning, doing and monitoring, and that some aspects of what is seen as a problem are likely to be a mismatch between intention or expectation and outcome."

Although depicted as being distinct components, the hard and soft systems interact. The educational - learning management process framework of Loftus and Cary (1980) represents the hard system as a part of the overall soft system. This view is supported by

Checkland (1981) who stated, "The relation between the two would seem to be that the hard paradigm is a special case of the soft."

Farm management research moved towards the soft component of management with the addition of utility and Bayesian probability principles to the hard system models to predict farmer behaviour, but not to understand the determinants of behaviour and how these determinants change or are open to change over time.

This research study is set in the soft systems research context where the management problem is conceived not only to consist of hard technical, biological and financial relationships, but also how managers perceive and learn about these relationships in order to maximise their objectives, i.e. how the manager interacts with his perceived production system.

Specifically, this research implements the techniques of concept elicitation, paired comparison surveys utilising direct magnitude estimation, Multiple Discriminant Analysis, Multiple Regression and Metric Multidimensional Scaling (MDS) to structure the 'soft' component of the management system. Developing a structure of the soft component is based upon theoretical models of behaviour (i.e. decision making) which identify and measure the underlying perceived relationships, shaping an individual's perception.

Soft systems introduce the concepts of an individual developing a perception of the real world system, providing a reference for determining behaviour. An individual interacts with two systems, the real world system and a perceived interpretation of the real world, with separate individuals differing in their interpretation as a function of their experience and cognition.¹

¹ Cognition is defined as "Action or faculty of knowing, perceiving, conceiving as opposed to emotion and volition; a perception, sensation, notion or intuition". (Concise Oxford Dictionary, 1964).

2.1.0 BEHAVIOURAL MODELS

2.1.1 Attitude - Black Box

Early behavioural researchers viewed behaviour as being determined by an individual's perception of the behaviour. Allport (1935) defined this perception as an "attitude" which was described as a "mental or neural state of readiness organized through experience, exerting directive or dynamic influence upon the individual's response to all objects and situations to which it is related."

Attitudes were measured in terms of an individual's perception to a behaviour as being either favourable or unfavourable, and were used as a predictor of behaviour. No understanding of the determinants of an attitude were discovered, limiting the value of such an approach from a soft system sense.

2.1.2 Fishbein and Ajzen Model of Reasoned Action

Fishbein and Ajzen (1975) retained the concept that behaviour is determined by an individual's perception of a situation, in developing a model of reasoned action. (see Figure 2.1).

Krech et al (1962) followed by Triandis (1971) disaggregated the attitude concept. The multicomponent view of attitudes consisted of an "Affect" (emotion to an object), "Cognition" (consisting of the basic idea) and a "Behavioural" (a predisposition to act) component, and was presented in an attempt to provide greater insight into the underlying relationships shaping the "attitude", offering researchers the potential to understand and possibly intervene in the soft system component to influence behaviour.

Ajzen and Fishbein (1980) stated the purpose of their model as being "to predict and understand behaviour, as some degree of understanding is necessary for producing change."

Figure 2:1 Diagrammatic Representation of the Fishbein and Ajzen model. (Ajzen and Fishbein 1980)

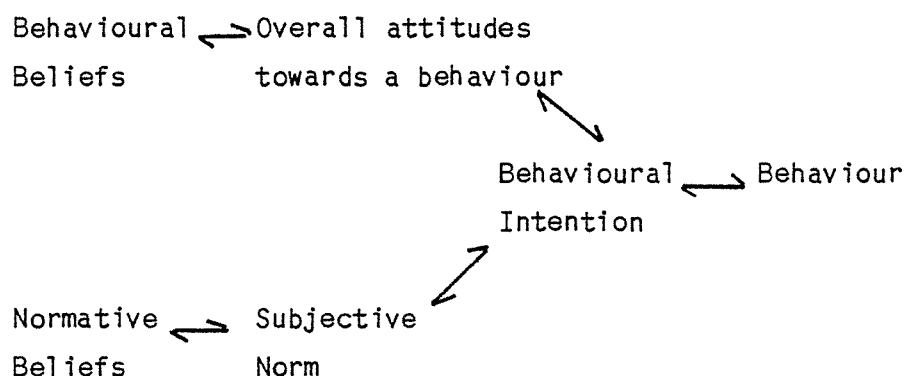

The determinants of behavioural intention² (the determinant of the likelihood of behaviour to an act) are presented as the overall attitude towards the act and the subjective norm, which are combined into an index of behavioural intention towards a specific act.

Ajzen and Fishbein (1980) contend that the three components of attitude proposed by Krech et al (1962) and Triandis (1971) are equivalent to the components of their model of reasoned action. The affective component being equivalent to the overall attitude, with the cognitive and behavioural components equating to beliefs and behavioural intention, respectively; where behavioural intention is defined as "... a person's location on a subjective probability dimension involving a relationship between him and some action."

To predict behaviour, knowledge of an individual's behavioural intention towards the act in question is sufficient. However, to understand that behaviour, knowledge of the determinants of behavioural intention is necessary.

² Behavioural Intention is viewed as equivalent to the original attitude concept utilised by early behavioural researchers.

This study focuses on the determinants of the overall attitude towards the act of adopting high fecundity sheep production systems and ignores the undoubtedly important determinant, the subjective norm³. While farm management research extension workers must be aware of the subjective norm component of behavioural intention (see Gibbs, 1973), in practice their main function is directed towards shaping the overall attitudes held by farmer clients.

The overall attitude (A) component of the Fishbein and Ajzen model of reasoned action can most easily be illustrated by a simple example.

³ Subjective norm is the normative component of behaviour and deals with the influence of the social environment on behaviour. The subjective norm is the individual's perception that most people who are important to him, think he should or should not perform the behaviour in question. Woelfel and Haller (1971) define the normative component as being the perceived influences of significant others on an individual.

Warshaw (1980) claimed that the normative component added little additional predictive power over and above the attitudinal component, noting that the separating out of the normative component probably resulted in measuring over-lapping rather than independent dimensions of intent, as the normative component is highly inter-correlated with the attitudinal component.

Consider a behavioural act (B) and a set of perceived outcomes associated with the act: $O_1, O_2, O_3, \dots, O_n$. Let b_i be the strength of the belief (subjective probability) that outcome O_i , will result from the act (B). Let a_i be a positive/negative measure of the evaluative attitude towards the i^{th} outcome. In the Fishbein and Ajzen model of reasoned action, overall attitude (A) towards the act (B) is given by some function of the products: $a_i b_i$; specifically

$$A = \sum_i a_i b_i \quad 2.1$$

Behavioural intention towards the behavioural act is then given by the index

$$BI = \beta_A A + \beta_S SN \quad 2.2$$

Where SN is the subjective norm and β_A and β_S are weights to be determined empirically.

Fishbein and Ajzen (1975) defined the overall attitude as being "a learned predisposition to respond in a consistently favourable or unfavourable manner with respect to a specific object," which incorporates the belief and evaluative attitude components. An evaluative attitude being "... his (an individual's) positive or negative evaluation of his performing the behaviour ... Quite simply, an attitude is an index of the degree to which a person likes or dislikes an object ..." (Ajzen and Fishbein 1980).

Attitudes can be anything from strong to weak in either a positive, negative or neutral sense.

Oskamp (1977) defined beliefs as "assertions about the truth or falsity of propositions or statements about the relationship between an object and some characteristic." In a behavioural context, beliefs are cognitive links between two or more concepts of an individual's cognition, that may be true or false relative to

the real world.

Ajzen and Fishbein (1980) define beliefs as the subjective probability of a relationship between the object of the belief (i.e. high fecundity production systems) and some other concept seen to be relevant to the act by the respondent. Specifically beliefs are the subjective probability of perceived outcomes associated with an act.

Within a management decision (behaviour) context, there exists a set of beliefs and evaluative attitudes about a range of input decisions associated with the act (highly fecundity production systems), in addition to the beliefs and evaluative attitudes about the perceived outcomes to the act.

This fundamental difference can be represented diagrammatically (see figures 2:2a; 2:2b), where the original model utilises a set of outcomes associated with the act (Outcome concepts) whilst the management model associates a set of inputs (Input concepts) as well as a set of outcomes (Outcome concepts) with the act.

Within the management model, let a_i and b_i be the evaluative attitude and belief strength measures associated with the set of outcome concepts, $O_1, O_2, O_3, \dots, O_n$. Let a_j and b_j be the evaluative attitude and belief strength measures associated with the set of input concepts, $I_1, I_2, I_3 \dots I_n$.

The overall attitude (A) is then given by the equation

$$A = \sum a_i b_i + \sum a_j b_j \quad 2.3$$

Figure 2:2a Fishbein and Ajzen Model

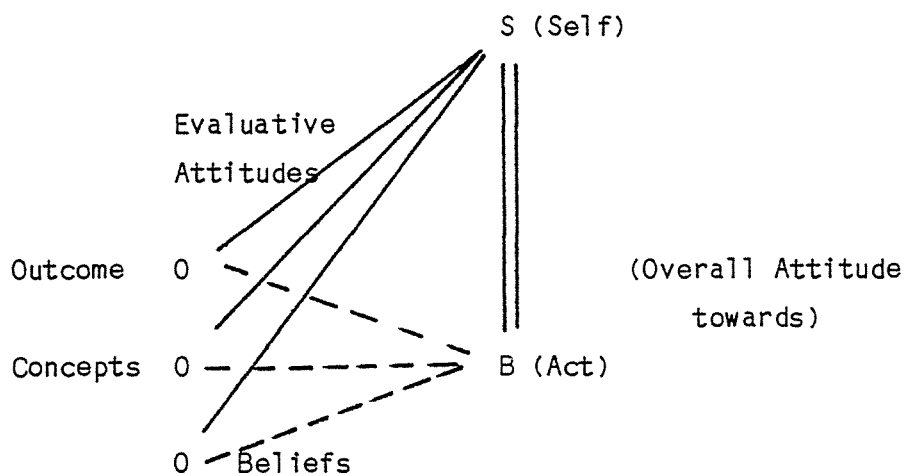
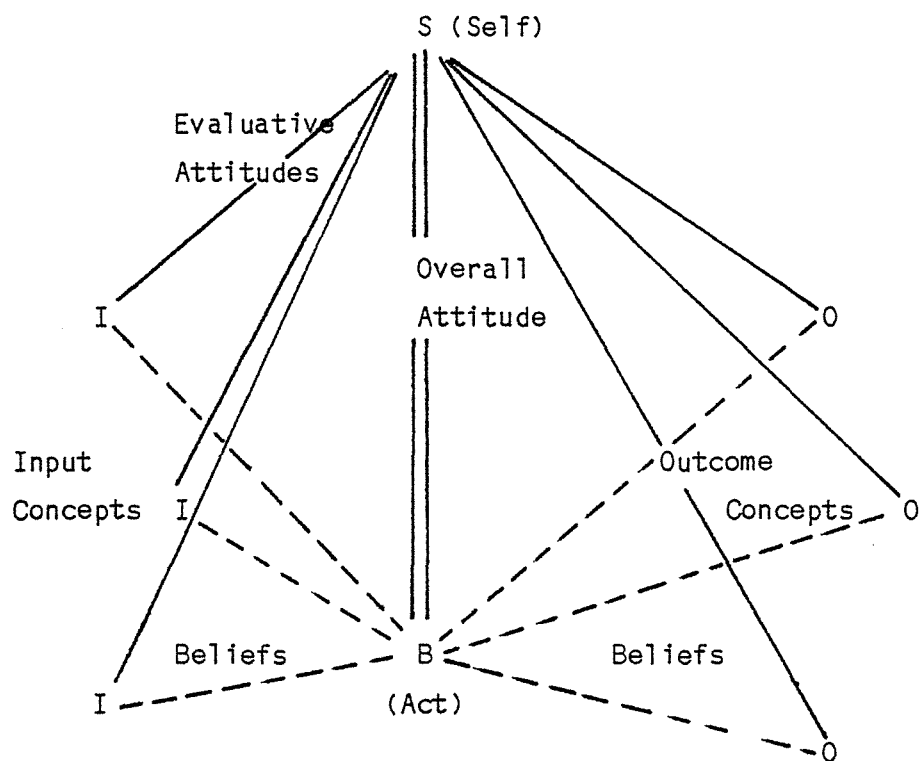

Figure 2:2b Management version Fishbein and Ajzen Model



The Fishbein and Ajzen model of reasoned action, by decomposing the all-encompassing view that "attitudes" determine behaviour into the underlying conceptual components associated with an act (specifically defined ⁴), allows the researcher not only to predict behaviour, but also increases the level of understanding with respect to how the behavioural intention is composed.

The advantage of this decomposition being that two individuals may have similar overall attitudes towards the 'act', but may have different belief and/or evaluative attitude structures. Knowledge of the different structures allows the researcher to understand an individual's overall attitude and target where influence could potentially result in a desired change (e.g. increased uptake of high fecundity production systems).

The application of the Fishbein and Ajzen model to the discipline of farm management research is analogous to the system's simulation modelling of the hard system in that the goal is to explain and understand why specific outcomes occur, rather than to just predict outcomes.

2.1.3 'Galileo' Model of Behaviour

Woelfel and Fink (1980) presented a theory of behavioural determinants, proposing a measurement system to represent these determinants which they labelled 'Galileo' theory.

⁴ Ajzen and Fishbein (1980) state that the act needs to be defined specifically in terms of the action, target, context and time to ensure that the intention measured is associated with the behaviour being researched.

The Galileo⁵ model of behavioural determinants envisages a series of input and outcome concepts associated with the concept of 'the act', i.e. principal beliefs, and 'self', i.e. evaluative attitudes. The overall attitude is the association between 'the act' and 'self'. The utilisation of elicited input - output concepts is likely to incorporate components of the subjective norm along with the measurement of self against the act and other reference concepts.

These components are the same as for the management version of the Fishbein and Ajzen model, with the redefinition of beliefs as principal beliefs (i.e. input and outcome associations to the act) and inclusion of a 'self' concept to separate evaluative and overall attitudes as depicted in figure 2:2b.

Woelfel and Fink (1980) incorporate the associations between and amongst the input and outcome concepts, i.e. the input - outcome, input - input and outcome - outcome associations. These associations are labelled as peripheral beliefs for this study as they do not involve a direct association with the 'act'.

The inclusion of peripheral beliefs enables the spatial representation of belief and attitude relationships within a multidimensional space, whereas Fishbein and Ajzen attempt to map beliefs and attitudes about objects onto an overall attitude. The utilisation of elicited input-output concepts is likely to incorporate components of the subjective norm along with the measurement of self against the act and other reference concepts.

⁵ Within this text 'Galileo' represents the theory and measurement system presented by Woelfel and Fink (1980).

Whereas Fishbein and Ajzen (1975) view each input and outcome concept as independent of each other, the 'Galileo' model views a dependence between all concepts including the concepts of the 'act' and 'self'. This view is supported by the empirical work reported by Warshaw (1980) who demonstrated that concepts displayed collinearity within the conventional Fishbein and Ajzen model (figure 2:2a).

The incorporation of peripheral beliefs within the 'Galileo' model increases the complexity modelled within the overall attitude framework. The objective of the Fishbein and Ajzen model is to determine a single index of the overall attitude derived from a series of input - outcome concepts whilst the Galileo model derives measures for each belief, evaluative attitude and overall attitude, resulting in $(n+2)(n+1)/2$ interpoint measures (where n equals the number of concepts and 2 represents the additional concepts of the act and self), which provide a means toward explicating a multidimensional representation of behavioural determinants. Multidimensional in the sense that a dimension is considered to be "nothing else than the mode and aspect in respect of which a subject is considered to be measurable;" (Descartes - cited in Woelfel and Fink, 1980).

Univariate representation of belief and attitude relationships will only be worthwhile if the dimension onto which the act, reference concepts (i.e. those input and outcome concepts associated with the 'act') and 'self' are measured, can capture the complete variance within the relationships.

Woelfel and Fink (1980) have presented a simple example. Given two points on an egg (one at each end), on the dimension running through each point, the points would be maximally separated. If however, the dimension represented an end view, i.e. a 90 degree rotation on the first dimension, the points may be identical. On their own, each of these dimensions provides a distorted representation of the shape and structure of the egg.

Shocker and Srinivasan (1979) view the Fishbein and Ajzen model framework as fundamental to multidimensional models which have developed because "conventional techniques sought pragmatically to obtain evaluations of alternative proposals rather than model the basis for those evaluations."

Two alternative techniques can be utilised to achieve a multidimensional representation of the belief and attitude relationships. Firstly, those attributes used by an individual to differentiate between the reference concepts, act and 'self', can be identified and then each input and outcome concept, the act and self can be measured (scaled) on each of these attributes e.g. on a map two points can be separated by a distance which is a combination of longitudinal and latitudinal attributes. To obtain the separation the longitude and latitude scales for each point are necessary. The scale values can be utilised to locate each reference concept, act and 'self' within a k - dimensional space where k equals the number of attributes used to differentiate the reference concepts, act and self.

The inclusion of peripheral beliefs enables the spatial representation of belief and attitude relationships within a multidimensional space, whereas Fishbein and Ajzen attempt to map beliefs and attitudes about objects onto an overall attitude.

Alternatively, measures of association between all reference concepts, self and the act (i.e. $(n+2)(n+1)/2$ measures⁶) can be utilised to spatially array the $(n+2)$ points within a $(n+2)$ dimensional space. The researcher does not require prior knowledge of the differentiating attributes and whether the attributes are orthogonal (independent) or not (correlated), as the $(n+2)$ dimensions on which the points are arrayed are derived according to the specific factoring technique utilised. (See chapters 3 and 4).

⁶ The Fishbein and Ajzen model utilise $2n+1$ of these distances, i.e. principal beliefs, evaluative attitudes and the overall attitude.

Greer (1982) stated that "beliefs are the building blocks of attitudes." In the Fishbein and Ajzen, and 'Galileo' models of behaviour and in the terminology adopted in this study, beliefs (both principal and peripheral) and evaluative attitudes are the building blocks of the overall attitude to a specific act. The overall attitude to a specific act (a high fecundity production system) reflects the perceived link between the act and self.

Figure 2:3 Diagrammatic Representation of the Conceptual Behaviour Model utilised by 'Galileo' Theory

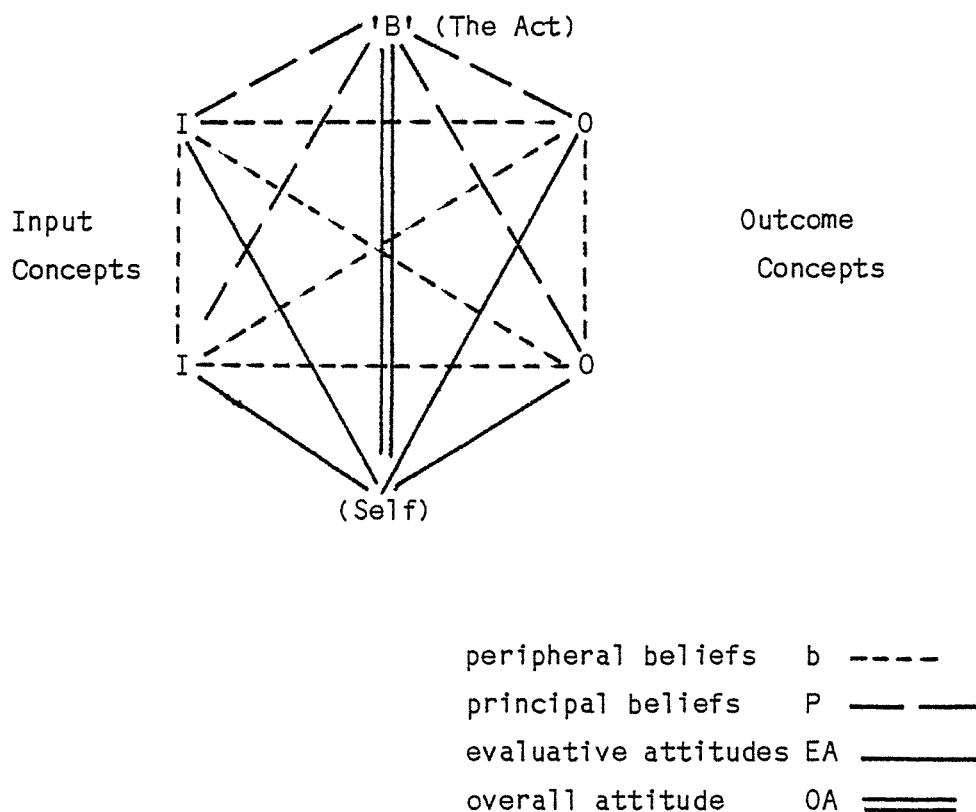

2.1.4 Attitude - Behaviour Link

Early attitudinal research assumed that a direct relationship existed between the overall attitude and subsequent behaviour of an individual. This assumption arose largely from the definition of an attitude, i.e. "a predisposition to act" (Cushman and McPhee, 1980).

Subsequent research into the overall attitude-behaviour relationship found little evidence to justify the above assumption. The lack of justification has been related to methodological inadequacies in that the behavioural criterion used to measure the attitude-behaviour relationship were in fact behavioural syndromes (e.g. racial preference and too all encompassing to provide any significant evidence of the relationship).

Wicker (1969) and Liska (1974), in reviews of the overall attitude - behaviour link, claimed either little or no association had been demonstrated. Schuman and Johnson (1976) concluded that "attitudes and behaviour are related to an extent that ranges from small to moderate."

However Ajzen and Fishbein (1980) and Woelfel (1980) claim that the increasingly positive relationship demonstrated by empirical studies, between attitudes and behaviour was due to conceptual (i.e. decomposing of attitudes into behavioural determinants) and methodological (i.e. increased specificity of behavioural criterion and the precision of measurement techniques) advances.

The Fishbein and Ajzen model and theory is viewed as being fundamental to a range of market research techniques designed to predict and understand consumer behaviour (Shocker and Srinivasan, 1979) and also as being useful in the prediction and understanding of behaviour within a positive farm management research sense (Maughan 1980). The determinants of behaviour as depicted by Fishbein and Ajzen (1975) and expanded by the 'Galileo' theory provide the basic framework for the modelling of farmer perceptions of a high fecundity sheep production system utilised in this study. The models are presented as the static representation of the soft component of management at that particular time, i.e. the models reflect the learning processes that managers have undertaken up to that point in time, with the potential to be extended into the dynamic aspect of the soft system component of management.

Within a management context, behavioural intention is a dynamic concept, extending from the initial perception of a situation, through the management process, to observing and monitoring decision outcomes, modification of the determinants of behavioural intention, in some learning continuum through time. This dynamic aspect of behaviour is not formally accounted for by the Fishbein and Ajzen model of reasoned action or by the Galileo model as presented.⁷

2.2.0 SOFT COMPONENT DYNAMICS

2.2.1 Learning and Knowledge

To the degree that actual outcomes differ from expected (conceived) outcomes, a new problem arises creating a learning environment, resulting in the manager's perception of the real world being reinforced or adjusted to cope with the actual experienced outcome.

The concept of 'to learn' is defined by the Concise Oxford Dictionary (1964) as "Get knowledge of (subject) or skill in (art etc) by study, experience or being taught; commit to memory; become aware of by information or observation ...". Learning is considered to be a change in the relative state of knowledge, where knowledge is a state of theoretical or practical comprehension. Rogers and Shoemaker (1971) referred to knowledge as the portion of a manager's perceived world in alignment with the real world system. The degree of equivalence between the real and perceived world may vary according to the type of knowledge considered.

⁷ Due to the 'Galileo' measurement system, the Galileo model may offer the potential to monitor the dynamic aspects of behaviour. A measurement system based upon the real number system with an accompanying spatial representation would enable a time series of representations to occur, which may reflect the change in cognitive structures across time, i.e. the dynamic aspect of behaviour.

Rogers and Shoemaker (1971) presented a three stage knowledge hierarchy reflecting the level of experience and learning achieved, and an increasing level of utility with respect to comprehending the real world system viz:

- 1) 'Awareness' knowledge equates to the portion of the real world system content perceived by an individual.
- 2) 'How to' knowledge is the information necessary for the implementation of a production or management system, with greater amounts necessary for increasingly complex systems.
- 3) 'Principles' knowledge refers to the functioning principles underlying a system. Usually "... it is possible to adopt and use an innovation without the possession of principles knowledge, but the long range competence of individuals to judge future innovations is facilitated by principles know-how." (Rogers and Shoemaker, 1971).

Within the farm management discipline, the need for principles knowledge is highlighted due to reduced managerial control and the often long term nature of decisions which can influence future innovation or behaviour.

2.2.2 Learning Theories

A static representation of behavioural determinants leads into the basis of soft system dynamics, i.e. the learning processes.

Mahoney (1974) presented two basal streams of learning theories, viz:

- 1) The behaviourist theories, based upon the individual having favourable actions rewarded and unfavourable actions punished, with the actions being an interaction with the individual's environment.

A simple example is when an individual encounters an electric fence for the first time, where the action of touching the fence results in a punishment. Learning occurs in that the electric fence is associated with a negative reward, increasing the likelihood of the individual not touching the fence in the future. Behaviourists view man as a machine reacting to his environment.

- 2) Cognitive information processing theories, which view learning as purely internal, where individuals respond to their perceived environment. Cognitive theories view information as the basic element in learning, creating change to the reference concept self and act inter-relationships, i.e. the attitudes and beliefs.

Man is viewed as an active processor of experience, rather than a composite of stimulus - response linkages. Utilising the same example, the cognitive approach is that man has a perception of the likely outcomes associated with touching the fence. If the perception is one of no pain resulting in touching the fence, the experience of pain is seen as inconsistent with the existing perception resulting in changes to the existing perception (i.e. learning) in an effort to minimise the inconsistency.

Mahoney (1974) claimed that a third stream of learning theories (i.e. Man the Scientist), representing a convergence of the two basal streams had occurred. Man as a scientist was considered to perceive his environment and then react to any observed outcomes.

2.2.3 Personal Construct Theory (P.C.T.)

The concept of 'Man the Scientist' was first postulated by George Kelly (1955) in his theory of Personal Constructs.

Man is considered to be a scientist in that future events are predicted, with the resultant outcomes observed, so that similar events in the future can be anticipated with greater certainty.

Kelly claims that an individual's processes are psychologically directed by the way in which he anticipates or construes events, i.e. individuals are assumed to strive to understand the future rather than simply react to the past.

The ultimate aim for individuals, as for scientists, being to predict and control future events.

Individuals predict outcomes resulting from their potential actions within a given environment, i.e. construe with each construct set relating to some act, object or event, with each individual developing a unique construct system resulting in different behaviour relative to the same object, act, etc.

Within the terminology used in this study, constructs consist of belief (peripheral and principal) and attitude (evaluative and overall) relationships.

Kelly's process of construing is a process of learning, with the premise that behaviour is conditioned by anticipated and observed outcomes. Individuals develop construct systems about a specific act, object or event which are tested by viewing the outcomes that occur. To the extent that anticipated outcomes do not agree with reality experienced, a learning environment exists, within which individuals will adjust their construct system, in order to be able to predict the outcome that was experienced.

Within a farm management context, the difficulty of accurately construing increases due to the complexity of behavioural determinants interacting along a time dimension. Input and outcome concepts comprise a range of possibilities requiring the manager to integrate the various levels of each concept with the remaining concepts. The cognitive task of the manager is highly complex, which is further compounded by the biological influences on the

production system providing a range of outcomes for each set of input and outcome concepts. P.C.T. implies that people do not necessarily learn from experience alone, but learn from reviewing the meaning which they attribute to the experience, i.e. the personal meaning of experience for an individual is the determinant of any action. P.C.T. views learning as the adjustment of an individual's belief and attitudes with respect to the real world as it is experienced.

Salmon (1980) and Woog (1980) cast the farmer as a 'scientist' with the farmer interacting with his environment creating a cognitive interaction, as experience is processed.

It has long been recognised in farm management 'hard systems' research that farm surveys are a valuable research methodology since "every farm is an experiment station and every farmer the director thereof" (Warren, 1945). However, a construct theory approach to farm management research concentrates on the farmer as research director, "to find out how he ordered his world, rather than how he behaves in relation to it." (Salmon, 1980).

The decomposition of behaviour into the determinants of behaviour, and knowledge of how these determinants change or adjust over time, should increase the level of understanding of how individuals learn and why they manage their production system in a particular way. In the long run this should enable a more directed intervention by identifying the cognitive relationships inconsistent with the successful adoption of an act as represented by a set of expert belief and attitude relationships. The ability to objectively quantify the behavioural determinants which result from subjects interacting with their environment across a time dimension would provide the first step towards monitoring the dynamic behaviour - learning processes.

2.2.4 Adult Learning

Tough (1973) reported the findings of a Canadian study in which adults undertook an average of eight learning projects per annum, with 98 percent undertaking at least one project. Seventy percent of all projects were self directed in that the learning episode was initiated, planned and directed by the learner, indicating that on the whole individuals have to perceive a need to learn prior to any learning episode being initiated. Tough (1973) noted that the majority of learning projects were goal oriented. Houle (cited in Underwood and Salmon, 1979) claimed that the ambition to learn was not universal and that adult learners had one of three objectives viz:

- 1) A specific goal orientation.
- 2) An activity orientation aimed at satisfying "social needs."
- 3) A learning orientation aimed at learning for learning sake.

Individuals may seek a specific piece of information to attain their objective. However, in some situations information may need to be transformed prior to being integrated into the construct system.

Once integrated, the information is applied to achieve the goal for which the learning project was undertaken, i.e. the information once obtained is incorporated into an individual's construct system and is then used to anticipate the outcomes of future actions. To the extent that these outcomes do not occur the construct system is adjusted (or even forgotten) to increase the predictability of similar outcomes in the future.

The key concept of adult learning theory being that 'Man is a self directed learner', requiring goals and objectives to achieve the direction of learning and some evaluation of outcomes and events to initiate further learning episodes.

Salmon (1980) combined Tough's self directed learner and Kelly's man the scientist concepts into a Kellian approach to self directed learning, claiming Tough's concepts to be an integral part of personal construct theory (see figure 2.4). The individual (farmer) is viewed as interacting with his environment and having identified a need for knowledge, interacts with advisors to obtain the required information and knowledge.

Figure 2:4 Kellian Approach to Self Directed Learning (Salmon, 1980)

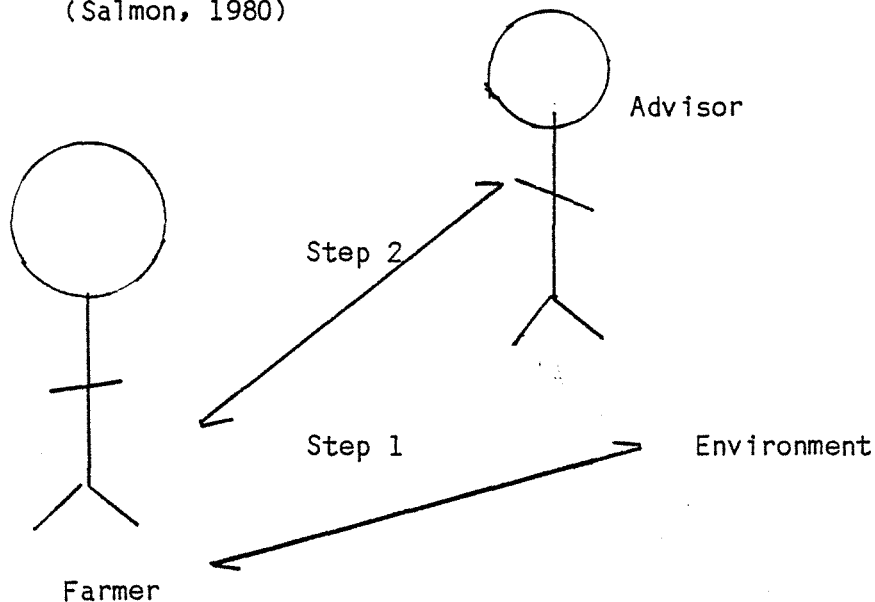

However, according to Tough (1973) an individual is most likely to approach those people with whom they interact (i.e. peer group) prior to approaching an advisor. Figure 2.4 is misleading as Salmon (1980) makes no distinction as to the sources of information (and their relative importance) utilised by the farmer. Personal construct theory does however incorporate the self directive learning concepts of Tough (1973) which provides stimulation for the construing process.

2.2.5 Learning - A Farm Management Extension Research Context

Personal construct theory and adult learning concepts offer the basis for understanding the construct system of an individual, allowing the learning process to be monitored. Personal construct theory adds a time dimension to the static Fishbein and Ajzen and Galileo representations of the soft system component of management.

Extension has been defined as "a service or system which assists farm people through educational procedures in improving farming methods and techniques, increasing production efficiency and income, bettering their level of living and lifting the social and educational standards of rural life" (Farquhar, 1962 - cited in Squire and Hughes, 1973). The role of extension workers was placed even more strongly in the role of teaching and learning by Raudabaugh (1956 - cited in Squire and Hughes, 1973) i.e. "... the extension teacher serves people by teaching them how to help themselves; in so doing, he teaches people, not subject matter. He teaches people how to think, not what to think." Raudabaugh's view of the extension worker fits with the adult learning concepts of Tough (1973) in that the majority of learning is self directed and not a reaction to an advisor's direction.

Acceptance of the Personal Construct theory of learning requires extension practitioners to understand the constructs of an individual, - defined as reciprocal relationships (Emery and Desar 1958), empathy (Keith-Lucas, - cited in Woog, 1982); and commonality (Woog, 1980 - cited in Woog 1982), which are seen as necessary relationships for the farmer to understand and relate to an innovation the advisor is attempting to communicate.

Several communication and extension models have used the concept of empathy between an extension worker, farmer or subject, and an object, with each party developing an understanding of the others' construct systems. Examples include the Successful Communication

Model of Emery and Oesar (1958) and the Personal Interaction Model of Woog (1980). Once the extension worker has perceived the problem or object from the subject's point of view, specific beliefs or evaluative attitudes can be targeted for change in order to change the subject's overall attitude and hence behavioural intention.

Salmon (1980) developed a resource model of extension (figure 2.5) where the basic concept is a pool of knowledge which resides in all aspects of the industry, with each participant in the industry contributing to the pool. The function of extension being to transfer and nurture this pool of knowledge, implying that all individuals within the system have an extension role at some point in time. The model assumes individuals to be self directed in that they actively seek out the knowledge most relevant to their perceived needs and problems. This may be awareness knowledge for a new problem, how to knowledge for an existing unresolved problem or principles knowledge to understand the problem, which is integrated into individual constructs.

Salmon's model implies that, over time, individual cognitive structures will converge to a degree of alignment, for the same act, problem or situation. As the cognitive structure determines behaviour, managers of high fecund production systems would be predicted to have similar beliefs and attitudes, to those extension and research personnel working in the area of improved sheep production systems, while low to average performance farmers would be predicted to display a different belief and/or attitude structure.

Figure 2:5 Resource Model of Extension (Salmon, 1980)

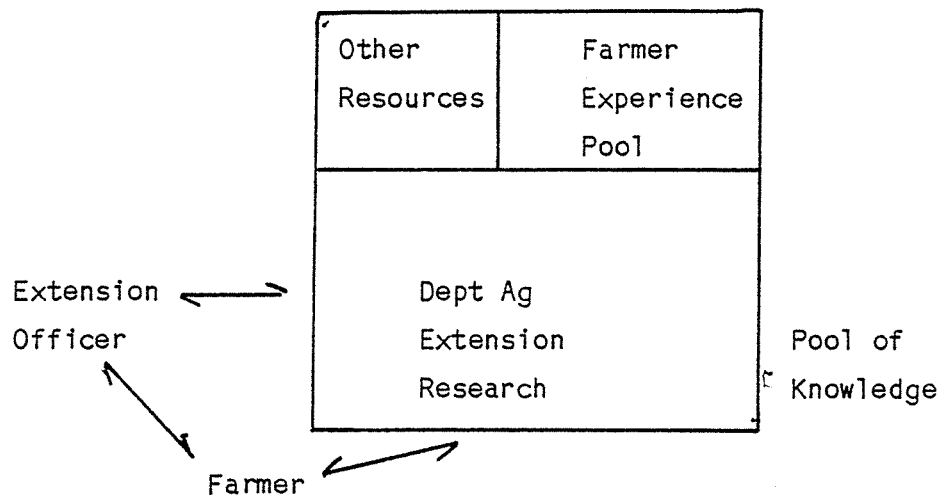

To the extent that beliefs or attitudes do not align across groups of managers from differing performance levels, an opportunity exists to enhance the state of knowledge. According to personal construct theories this can be achieved by manipulating the cognitive relationships of say a low performance group in such a way as to obtain similar beliefs and attitudes to a group of experts as representatives of the real world system, increasing the likelihood of achieving a higher performance.

The management of the extension process involves three separate and constituent parts, (Squire and Hughes, 1973), viz:

- 1) Advisory Process; involving the activities of extension workers in defining objectives, planning, implementing plans and evaluating.
- 2) Communication Process; involving the link with the farmer, i.e. commonality.
- 3) Adoption and Diffusion Process; involves the farmer and the stages of adoption that are passed through, with diffusion

relating to the level of adoption throughout the whole rural community.

Extension management requires that farmer cognition be monitored in some fashion, either directly by quantifying cognitive structures or indirectly through farmer behaviour, for the purpose of evaluating the effectiveness and efficiency of alternative extension intervention strategies.

Squire and Hughes (1973) noted that the manner in which farmers use information available to them relative to a production system is important, stating that:

"Although intuitive judgements have been, and will in many cases in the future be, the only method available for judging levels of knowledge, skill and attitudes, in more formal evaluation studies in extension some method/s of measuring actual levels of knowledge, skills and attitudes will be needed." (Emphasis theirs).

The Massey Extension Model of the extension process (Squire and Hughes 1973) views evaluation as being central to the overall ongoing process involving planning, programming, implementing and recycling. Evaluation is necessary as each stage of the extension process requires a series of decisions which require valid information, often generated from the previous stage.

Typically the evaluation of extension practices has been associated with "management by objectives" principles in that objectives for extension strategies are set (usually in hard system performance terms), with successful strategies being those that achieve the desired system performance level. One potential difficulty in this approach is the identification of factors actually creating change, e.g. is the change brought about by a cognitive change as predicted, or as a result of biological variation.

In the New Zealand extension context, Cronin (1968), Hughes, Squire and Payne (1973), Armstrong (1980) and Smith et al (1979), utilise

measures of the hard system performance relative to either a control group of farmers not exposed to the extension strategy, or on a before and after extension strategy basis, to obtain comparative measures of hard system performance but not cognitive structure changes. McNeil et al (1985) questioned respondents on their views of an intensive extensive programme to complement the hard system performance data. However no measure of cognitive change was obtained and hard system performance was only measured during the actual extension service period.

2.3.0 SUMMARY

In this chapter the management system has been presented as consisting of two distinctive, but interconnected components. The hard system component consisting of the technical, biological and financial relationships underlying the production system, utilising the actual physical relationships that do exist, i.e. systems simulation models in a farm management research sense.

The soft system component that involves the manager's perceived interpretation of these relationships and how these change over time.

This research study has been placed within the soft component of the management system, with the objective of structuring and analysing the perceptions held by managers about a high fecundity production system.

The Fishbein and Ajzen model of reasoned action, which disaggregates the traditional 'attitude' term into behavioural determinants, is presented as being superior in predictive ability and also with respect to increasing the level of understanding achieved by the researcher, than the traditional 'black box' model.

The Fishbein and Ajzen model identifies and defines beliefs, evaluative attitudes and overall attitudes, along with the

normative component of behaviour, as being the behavioural determinants. Beliefs are defined as the perceived relationship between an act and a range of input and outcome concepts. Evaluative attitudes are defined as the perceived relationship between the input or outcome concepts and 'self', whilst the overall attitude consists of the summed products of the evaluative attitude and the strength of belief about a range of input and outcome concepts associated with the act, i.e. the perceived relationship between the 'act' and 'self'.

The 'Galileo' model of behaviour was presented as extending the conceptual basis of the Fishbein and Ajzen model by incorporating peripheral beliefs, i.e. those interconcept associations not involving the 'act' and 'self' and the formal incorporation of a 'self' concept.

The potential advantage of the 'Galileo' model is the ability to represent the $(n+2)$ concepts for which measures of association are obtained, as points within a $(n+2)$ dimensional space providing a spatial representation of the belief and attitude relationships.

The 'Galileo' model avoids the distortions to relationships that occur when multidimensional inter-relationships are squeezed into a low dimensionality (less than $n+2$) space.

The dynamic aspects of the soft system component, i.e. the learning processes, were depicted within the cognitive experiential learning model framework. Learning is based upon a person's interaction with their environment, for which they have perceived certain outcomes. The observation of actual outcomes creates change to individual beliefs and attitudes which will tend towards the 'real world system' in the long run. The dynamic aspect of the soft system component requires the addition of a time dimension to the behavioural model. However, due to the limited time available, it has not been possible to study changes in the cognitive belief structure of farmers through time in this study.

Alternatively, the static behaviour models could be utilised to determine whether managers from higher performance production systems had beliefs and/or attitudes approaching the real world (as depicted by the perceptions of a group of relevant experts - scientists and advisors working in the sheep production discipline). This is the approach adopted within this study.

Chapter 3 discusses the measurement problems and processes utilised to obtain a set of $(n+2)(n+1)/2$ interpoint (belief and attitude) measures for developing a spatial representation of managers' beliefs and attitudes towards a high fecund sheep production system.

CHAPTER THREE : ISSUES OF SOFT SYSTEM MEASUREMENT

3.0.0 INTRODUCTION

This chapter presents three measurement objectives relative to the representation of cognitive structures. The alternative behavioural models discussed in chapter 2 are considered in terms of their measurement requirements and the specified objectives for representation of cognitive structures in the context of an act (i.e. high fecund sheep production systems).

3.1.0 MEASUREMENT OBJECTIVES

Four measurement objectives, with respect to the quantification of beliefs and attitudes towards a high fecundity production system, were adopted in the context of the research study, viz:

- 1) To quantitatively describe and spatially represent the belief and attitude relationships relative to an act, to provide an understanding of how a sample of managers perceive a high fecundity production system.
- 2) To identify and measure any differences in the beliefs and attitudes held by different performance groups within the population sample. Identification of between group differences in cognitive structures should allow targeting of hard systems research and extension activity.
- 3) Given an understanding of the belief and attitude relationships of the population sample, and also of separate performance groups within the sample, develop efficient and effective intervention strategies for the increased adoption of the act.

Specifically, the measurement objective is to estimate the efficiency and effectiveness of extension strategies over time by measuring changes to the beliefs and attitudes of extension client groups, relative to their overall attitudes with respect to specific acts.

3.2.0 MEASUREMENT OF BEHAVIOURAL DETERMINANTS

To quantify the relationships which determine individual or group behaviour requires the identification of concept inter-relationships used by the individual or group to define and describe the act. These concept inter-relationships will vary depending upon which conceptual model of behaviour is adopted and upon the objectives that the measurement system is attempting to achieve.

3.2.1 Attitude as a Black Box

The adoption of overall attitude as the sole all-encompassing determinant of behaviour requires only the specification of the act and a measure of overall attitude toward the act (e.g. by asking respondents to rate their opinion of the act on a favourableness continuum). The overall attitude provides a measure of the likelihood of performing the act, but provides very little information of how the respondents perceive the act. Such a model does not assist in the attainment of the measurement objectives of this study.

3.2.2 Fishbein and Ajzen Model

The management model of behaviour as depicted within the Fishbein and Ajzen (1975) framework requires the identification of reference concepts associated with the act and the measurement of both principal beliefs (concept - act relationships); evaluative attitudes (self - concept relationships) and the overall attitude towards a specific act, (self - act relationship).

A measure of the overall attitude is necessary in order to empirically determine the β weights within the Fishbein and Ajzen framework.

Principal beliefs (subjective probabilities) involve measuring the strength of association between specific concepts and the act, (denoted by b_i and b_j in equation 2.3).

Evaluative attitudes involve measuring respondents evaluation of each reference concept on a good/bad (positive/negative) dimension, (denoted by a_i and a_j in equation 2.3).

Overall attitude toward a specific act can be regarded as an index of respondent expected utility from the act, and must also be measured.

The proposed management model of Fishbein and Ajzen can assist in achieving the first objective of this study, i.e. understanding the basis of an individual's or group's overall attitude and hence behaviour towards an act.

In the broad context of the Fishbein and Ajzen model, it is possible to consider alternative specifications for the overall attitude index (A).

For example:

$$A = \sum \beta_i (a_i b_i) + \sum \beta_j (a_j b_j)$$

This relationship will be referred to as the multiple regression version of the Fishbein and Ajzen model. Potentially, this model offers increased predictive capacity thus assisting in the attainment of objectives one and three.

Where we don't have an index of overall attitude, but just knowledge of which group an individual belongs to, we can use multiple discriminant analysis to estimate the B weights.

3.2.3 Galileo Model of Behaviour

The Galileo model of behaviour utilises an extended Fishbein and Ajzen framework but differs conceptually in the definition of cognitive relationships, in that belief (principal and peripheral) and attitude (evaluative and overall) relationships are considered to constitute a mental (cognitive) map.

The structure (layout) of the cognitive map reflects an individual's experience of the real world system. Perceived distances between reference concepts, 'self' and an act are assumed to be some function of similarity with smaller distances representing stronger beliefs, i.e. belief strength is an inverse function of distance separating reference concepts. Galileo methodology obtains measures of belief and attitude relationships utilising a paired comparison of all reference concepts, 'self' and an act.

Given the pairwise distance between inputs, outcomes, the act and 'self' (i.e. $(n+2)(n+1)/2$ distances),¹ multidimensional scaling techniques can be utilised to locate the co-ordinates of the (n+2) points within a (n+2) dimensional space, reflecting the pairwise distances elicited as representing the cognitive maps of the respondent.

The Galileo model analysis, offers the possibility of an increased level of understanding of the belief and attitude relationships in determining the overall attitude of an individual (or group of individuals) to an act, through their multidimensional spatial representation rather than the more constrained representation in terms of the Fishbein and Ajzen model.

The comparative analysis phase of the Galileo methodology compares spatial representations between pairs of groups. Two spatial representations can be rotated onto a common set of co-ordinates and to the extent that similar concepts differ in location from one group to another, differences can be identified and measured.

Objective three requires the utilisation of the belief and attitude relationships to predict changes within the cognitive relationships over time and model these changes in order to measure the effectiveness and efficiency of extension strategies. Within the Galileo methodology the opportunity exists to predict change (i.e. motion of a reference concept, self or the act relative to the set of co-ordinates and to the remaining reference concepts) according to the physical motion laws of Newton and Galileo (Woelfel and Fink, 1980). Change is predictable in that when two or more concepts are associated within a message, they are predicted to move relative to the other concepts with the message acting as a

¹ Where there are n reference concepts plus the concepts of 'self' and an 'act'.

linear force between the associated concepts. Actual changes could be monitored over time, thus developing a time series of spatial representations for a group, which could then be rotated onto a common co-ordinate set for comparative purposes.

3.3.0 SUMMARY

For this research study, the Galileo methodology and associated behavioural model were utilised due to their ability to quantitatively achieve the measurement objectives. In addition, the Galileo model utilises all the principal belief and evaluative attitude measures required to analyse behavioural determinants based on the Fishbein and Ajzen model of reasoned action.

3.4.0 MEASUREMENT SYSTEMS

3.4.1 Introduction

The measurement task within a soft systems behaviour modelling context, as depicted by the Galileo methodology, comprises three distinct tasks, viz:

- 1) The identification of reference concepts, between which the belief and attitude relationships are to be measured.
- 2) The measurement system utilised to represent the belief and attitude relationships.
- 3) The presentation of the measurement task to respondents in such a way as to minimise the associated respondent burden.

3.4.2 Reference Concept Identification

Cognitive Experiential Learning theory assumes that individuals represent experience internally in memory (i.e. cognition) and thought by a set of reference concepts, with changes in their inter-relationships (separations) and the addition and/or deletion of reference concepts, over time, representing the learning process.

The first measurement task in the construction of a cognitive map for an individual or group of individuals is to identify the set of reference concepts relative to the object, act or acts (high fecundity sheep production system in this study). In order to simplify this task, the cognitive map for a specific act is assumed to be an independent entity relative to the total cognitive map for each individual. The section of the total cognitive map associated with a specified act is described as the cognitive domain of the act. Reference concepts included in the cognitive domain of an act are assumed to have some benefit or cost aspect to the individual, relative to the specified act.

In order to identify reference concepts it is necessary to define the object or act in such a way that all respondents refer to the same real world system, even though respondents may perceive this system (i.e. domain of the act) differently. Ajzen and Fishbein (1980) state that the act needs to be defined in terms of the action involved, the target of the action, the context of the action, and the time of the action. Each or any of the four action criteria can be specified on a totally general level (e.g. adoption of rotational grazing) through increasing detail (e.g. adoption of a 60 day winter rotation on grass for replacement ewe hoggets). The level of specification adopted should be the same for all respondents, since the same individual may use different reference concepts for the same act defined in different levels of detail.

Of prime importance among the set of reference concepts relative to a specific act is the concept of 'self'. This concept is likely to

be difficult for a respondent to depict within the context of a cognitive map representing the domain of an act. For every act and associated domain, defining the total cognition of an individual, there is assumed to be a corresponding 'self' concept. Dependence among this series of 'self' concepts is likely to complicate interpretation of the 'self' concept relative to a specific act for an individual. The Galileo model of behaviour and the Fishbein and Ajzen model of reasoned action assume independence between the set of 'self' concepts held by an individual.

In addition to the potential problem arising from the series of 'self' concepts, there exists two components of the 'self' concept relative to a specified act - the attitudinal and normative components (Mead, 1938; Fishbein and Ajzen, 1975). The normative component of 'self' representing the pressures to 'conform' with individuals with whom we react. A large body of research is based upon the impact of 'significant others' (Woelfel and Haller, 1971) and has been applied to extension research (Gibbs, 1973). Fishbein and Ajzen (1975) assume these two components to be independent, although some empirical evidence suggests a degree of dependence (Warshaw, 1980). In the Galileo methodology, the 'self' concept is a composite of attitudinal and normative components (Marlier, 1976), and the self-act relationship represents the Fishbein and Ajzen overall attitude to the act.

Woelfel and Fink (1980) categorised the remaining reference concepts (input and outcome concepts) as either contrived or accidental. Contrived concepts are those concepts used by the researcher to define the act and are imposed on the respondent.

A contrived concept creates a potential problem in that respondents are required to interpret the concept in a consistent manner in order to achieve meaningful measures of belief and attitude associations as intended by the researcher. In order to overcome potential interpretation problems, Myers and Alpert (1968) recommend that contrived concepts should not be used.

Accidental concepts are those specified by the respondent to define the act. Ajzen and Fishbein (1980), and Woelfel and Fink (1980), recommend the use of accidental concepts as they are stated in terminology used by the respondent, removing the need to interpret the meaning of the concept.

Accidental concepts can be identified using either structured or unstructured techniques. Structured techniques (e.g. Repertory Grid - Hughes, 1974) or partially structured techniques (e.g. Interactive Discussion - Walker, 1985) are difficult to implement without forcing or pre-empting replies from respondents that fit the cognitive map of the researcher rather than that of the respondent. This situation arises where the researcher structures aspects of the act's domain in his terminology in order to determine perceptions of the problem held by respondents.

Unstructured techniques are usually derived from in-depth interviews aimed at understanding the reasoning behind replies given by respondents (Hughes, 1974).

Woelfel and Fink (1980), Ajzen and Fishbein (1980) recommend the use of unstructured techniques to elicit accidental concepts from individuals or groups. Woelfel et al, (1977) suggest that interviewers remain in a passive role to ensure that accidental concepts are stated in the terminology of the respondent. In order to identify the total range of accidental concepts used by the population, as wide a cross section of respondents as possible should be interviewed. The assumption being that individuals or groups within the population associate different reference concepts with the act due to differences in cognitive structures.

Where the researcher is attempting to measure the cognitive structure of an individual, the accidental reference concepts consist of the elicited words used most frequently by the respondent in defining the act. (Ajzen and Fishbein, 1980).

When the task is to describe and compare cognitive structures across groups of individuals, where individuals may use different words to label the same reference concept and use varying numbers of concepts to define an act, the same concepts should be measured by all the respondents. (Ajzen and Fishbein, 1980)

To achieve a common set of concepts for all respondents, the words elicited during interviewing are aggregated into broad categories on the basis of similarity of meaning and frequency of useage criteria. Usually 10 to 15 broad categories will encompass seventy five to ninety five percent of the words elicited. (Woelfel and Fink, 1980).

Having identified the broad concept categories, which represent one reference concept, the word most frequently mentioned should be used to label the reference concept category (Ajzen and Fishbein, 1980, Woelfel et al, 1977). With any aggregation of words the reference concept label may not be universal throughout the whole population. Reference concepts derived from the aggregation of elicited words result in the concept being both an accidental concept and a contrived concept depending on whether the respondent uses the most frequently elicited word to label the associated concept. Potentially, reference concepts derived from the aggregation of elicited words create the problem of knowing whether a respondent needs to interpret the concept or not, and if so, is the interpretation consistent throughout the population.

Within the management model of behaviour utilised in this study, the size (i.e. number of reference concepts) and complexity (i.e. time - dimension) of each act is greater than the acts commonly used to develop behavioural models, e.g. taking birth control pills (Ajzen and Fishbein, 1980) and political voting behaviour (Woelfel et at, 1977). This suggests that a greater degree of aggregation of the elicited words may be necessary to ensure respondents are able

to reliably measure the concept inter-relationships.² The level of aggregation could be minimised if fractional factorial designs were adopted in association with larger sample sizes.

The aggregation of concepts associated with a managerial act should be restricted, on a within input or outcome basis, in order to avoid confusing or illogical reference concept sets containing both input and outcome components.

To minimise the interpretation problems associated with contrived concepts, Cary and Hughes (pers comm), Woelfel et al, (1977) recommend that a short phrase could be used to label the category, or alternatively a definition of the category provided in conjunction with the label, reducing potential interpretation problems associated with high levels of aggregation.

The potential problem of interpretation differences associated with contrived concepts is an area requiring further research to determine the effects of inconsistent interpretation and alternative strategies to overcome these problems. Such research was outside the scope of this study.

3.4.3 Measurement and Measurement Procedures

The second measurement task in the construction of a cognitive map is to measure the strength of association between reference concepts: concept - act (principal belief), concept - self (evaluative attitude), concept - concept (peripheral belief), self - act (overall attitude).

The objective of the measurement procedure is to give mathematical representation to the cognitive structure associated with a

² With a pair comparison task for n concepts, $n(n-1)/2$ non-redundant pairs exist, i.e. for 10 concepts, 45 pairs exist whereas for 15 concepts 105 pairs exist, limiting the number of concepts that can be measured without incurring the problems of respondent burden.

specified act, i.e. to represent the cognitive domain of the act: high fecundity sheep production systems. Specifically the measurement task overlays the elicited reference concept words (i.e. the 'art' of representing an act) with a mathematical co-ordinate system (the 'science' of representing an act). Therefore every concept in the domain of an act is given a unique location (i.e. the co-ordinates of the concept) which expresses the position of any one concept relative to all other concepts in the domain.

Psychometrics has developed the use of scaling techniques to measure behavioural determinants, where scaling "consists of ordering things in some meaningful way, such as labelling the units of a thermometer" (Dunn-Rankin, 1983). Scaling defines an object relative to other objects or points on that scale and as such "lends itself to the measurement of perceived variables where measurement is necessarily relativistic." (Woelfel and Fink, 1980).

Stevens (1951 - cited in Woelfel and Fink, 1980) present four levels of scaling measurement, viz:

- 1) Nominal scales: scales that discriminate differing objects, but are unable to order the objects.
- 2) Ordinal scales: scales that discriminate between objects and represent the (true) order of those objects.
- 3) Interval scales: scales that order objects in such a way that expresses the true magnitude of the separations among objects.
- 4) Ratio scales: scales that assess the true distance of each object from a zero point (origin) of an existing attribute.

The progression from nominal to ratio scales reflects an increasing level of precision and available information, allowing greater levels of abstraction in subsequent mathematical transformations applied to the scale values.

Torgerson (1958) presented the "additive constant" technique which can be used to convert interval level data to ratio level data increasing the utility of interval level data which may be easier for the respondent to provide.

Hughes (1974) categorised scales as being either open ended or closed depending upon whether a respondent was restricted to a segment of a continuum or not. Osgood's (1957) semantic differential involving seven categories between two reference points, i.e. good and bad is an example of a closed scale.

Fishbein and Ajzen use subjective probabilities as a measure of belief strength which involves a ratio level closed scale with an origin of zero (i.e. no association) and a upper limit of one hundred (i.e. a very strong association). Fishbein and Ajzen's measure of evaluative attitude is also obtained on a closed scale.

Woelfel and Fink (1980) measure belief and attitude relationships using an open ended ratio level scale ranging from an origin of zero representing no separation (i.e. total similarity) up to infinity for a very large separation (i.e. total dissimilarity). Such an open ended scale is most easily operationalised by using the real number system which extends from zero to infinity, as a symbol set for the scale. The advantage of open ended scales is an extension of Nunnally's (1967) findings that reliability increases with the number of categories on the scale available to the respondent. However, Nunnally (1967) concluded that beyond seven to ten scale values, most respondents may be unable to increase the reliability of their responses, implying that open ended scales as utilised by Woelfel and Fink (1980) may not offer the increased reliability theoretically possible.

The application of scales to belief and attitude relationships can be achieved through indirect or direct measurement techniques.

Indirect measurement techniques (Woelfel and Fink, 1980) assume that concepts are differentiated along a set of individual attribute scales. Such techniques require the researcher to have a prior knowledge of the attributes utilised by respondents to differentiate reference concepts in the domain of the act under study. Each reference concept, 'self', and the specified act can then be represented as some function of the individual attribute scale values. This function is known as the aggregate or complex attribute and can be used to measure the belief and attitude relationships. Application of indirect measurement techniques require the researcher to distinguish between reference concepts that constitute the domain of an act, and the attributes that differentiate reference concepts. It is not clear, for example, why profitability should be considered as an attribute of a reference concept, rather than a reference concept, and vice versa. Woelfel and Fink (1980) claim that reference concepts closely associated with each other are similar implying that an act, 'self' or reference concept is differentiated, at least in part, by other reference concepts, i.e. reference concepts would appear to be a subset of differentiating attributes.

Direct measurement techniques, as the terminology implies, measure the belief and attitude relationships directly using measures of proximity which are assumed to be a function of the complex (aggregate) attribute utilised to differentiate the reference concepts.

To illustrate the problem, consider the distance between two towns (x kilometres). This distance (the complex attribute) is some function of the longitude and latitude attributes for each town.

Alternatively each of the towns could be scaled indirectly on a longitude and a latitude continuum separately to determine the distance separating them. The difficulty with indirect measurement techniques being the need to identify all the attributes used to differentiate the concepts. In the example of the two towns, the identification of only one of either the longitude or latitude

attributes will under-estimate the true distance (x kilometres), distorting the inter-relationship between the two towns.

Fishbein and Ajzen (1975), Woelfel and Fink (1980) both recommend the use of direct measurement systems based on the complex attributes of association and distance respectively.

Woelfel and Fink (1980) recommend the use of open ended ratio level scales in a paired comparison format because such scales have the potential to carry more information than 10 interval semantic differential scales.³ The ability of these scales to carry more information increases the level of precision with which belief and attitude relationships can be measured.

3.4.4 Presentation and Ordering of the Measurement Task

The third measurement task in the construction of a cognitive map for an individual or group of individuals is the presentation and completion of the task by the respondents.

The direct measurement systems involving open ended ratio level scales were presented as theoretically offering increased levels of precision and accuracy. In order to achieve the increased potential of such systems respondents must understand and associate a minimum of burden with the measurement task required of them.

³ Woelfel and Fink (1980) claim 10 point semantic scales can carry from 2.32 to 3.45 bits of information per scale, whilst a typical Galileo study pair comparison can carry 9.97 bits of information per scale. A 'bit' of information being either a single digit or letter, i.e. the scale value 20 equates to three 'bits' of information. (Doyle, 1975).

To understand the measurement task a knowledge of the complex attribute (or attributes if indirect systems are used) that is being used to differentiate the reference concepts is necessary, i.e. is the measure a distance (proximity) or a subjective probability of association.

The respondents also require a knowledge of what level measurement task is required of them, i.e. is an ordinal or ratio judgement required to differentiate reference concepts. Woelfel and Fink, (1980), Ajzen and Fishbein (1980) utilise example measurement tasks and written instructions prior to the measuring of the belief and attitude relationships, in an attempt to familiarise respondents with the task required. Cary (pers comm) reported that in the experience of market research personnel, no dummy examples are necessary with respondents entering into the measurement task following only either written or verbal instructions to avoid any increase in task time and the associated increase in respondent burden.

Once the respondent understands the measurement system to be used, the researcher needs to manage the measurement task in such a way as to minimise the associated burden and/or direct the burden towards the least important components (if any).

Respondent burden exists with all tasks and is influenced by the length and difficulty of the task. (Hughes, 1974).

The length of the measurement task is directly related to the number of reference concepts between which associations are to be measured. The number of reference concepts can be controlled by the level of aggregation of elicited concepts resulting in interpretation problems or by the research design (i.e. a fractional factorial design would reduce respondent burden, but increase sample size).

Within a direct measurement system, using a ratio level scale in a pair comparison format, difficulty may be associated with the order

that the individual tasks are presented to the respondent. Fishbein and Ajzen (1975) and Woelfel and Fink (1980) make no recommendation with respect to the order of presentation of the measurement task to the respondent. This is possibly due to the reduced complexity of the acts that were being modelled. The separation of inputs and outcomes on a time dimension may have implications for the order in which respondents should be asked to consider measurement tasks on both a within and across concept pair basis.

The reference concept order can be used either to minimise the difficulty associated within each pairing (i.e. the ordering could be on the time dimension) or to direct the respondent burden on to the pairings which may be the most difficult by placing these towards the end of the measurement task, i.e. the pairings involving input - input and outcome - outcome associations are likely to be the most difficult as there may be little or no perceived dependence between the concepts.

One of the more difficult concepts to measure is the 'self' concept. Shocker and Srinivason (1979) state that respondents using indirect measurement techniques have difficulty in scaling 'self' reliably, due to 'self' being differentiated on separate or additional attributes to the remaining reference concepts. Fishbein and Ajzen (1975) account for the additional attributes by incorporating a normative component in addition to the attitudinal components. Woelfel and Fink (1980) utilise a complex attribute to differentiate all reference concepts which is assumed to account for both attitudinal and normative attributes.

Due to the importance of the 'self' concept to the overall Galileo model of behaviour, the author recommends that the evaluative and overall attitude measures be obtained early in the measurement procedure, to reduce the influence of any associated respondent burden attached to these measures.

3.5.0 SUMMARY

Chapter 3 defined the objectives of measuring belief and attitude relationships to an act (High fecundity production system) that were adopted in this research study. The objectives were stated as being to quantitatively describe belief and attitude relationships relative to an act in order to understand respondents perceptions of an act. To identify and measure any differences in the belief and attitude relationships that may exist between groups of respondents within the population. Thirdly to attempt to develop a model that optimally predicts respondent measures of overall attitude from the belief and attitude relationships. The final objective was to develop extension strategies based on respondent belief and attitude relationships and to measure the efficiency and effectiveness of these strategies to change the cognitive structure of a client extension group.

The behavioural models presented in chapter 2 were discussed relative to achieving the measurement objectives, with the Galileo model being preferred. The Galileo model, as well as achieving the measurement objectives, allows the researcher to construct the Fishbein and Ajzen model from the input data.

Measurement of cognitive structure was presented as comprising of three separate components.

The elicitation of reference concepts using unstructured interview techniques was presented as the first stage of measurement. Problems of aggregation and respondent interpretation associated with eliciting reference concepts from more than one individual were highlighted.

The second task was the choice of measurement system to measure the belief and attitude relationships. Direct measurement systems using open ended ratio level scales were presented as theoretically more reliable and accurate.

The final stage of measurement was associated with presentation of the measurement task to the respondent, in such a way to minimise respondent burden. The size and difficulty of the task were discussed with particular reference to the ordering of concepts within a paired comparison format.

Chapter 4 details Galileo methodology's use of the measurement systems outlined to achieve the four measurement objectives stated in chapter 3.

CHAPTER FOUR : GALILEO METHODOLOGY AND MULTIVARIATE ANALYSIS

4.0.0 INTRODUCTION

In this chapter the use of metric multidimensional scaling techniques based on a curved Euclidean co-ordinate system, to take account of inconsistency in human thought patterns, are discussed as part of the Galileo methodology.

The multivariate techniques of multiple discriminant analysis and multiple regression analysis are presented as being relevant to analysing the principal beliefs, evaluative attitudes and overall attitude relationships within the Fishbein and Ajzen model of reasoned action.

4.1.0 GALILEO METHODOLOGY

Galileo methodology has been described by those who developed the underlying theory as "... a complete system of research methods, including interview methods, questionnaires and a computer program designed particularly to measure beliefs, attitudes and thought patterns ..." (Woelfel et al, 1977).

Galileo methodology is based on the fundamental concepts derived by Galileo and Newton, and is a measurement system for the determinants of behaviour, which offers greater predictability than contemporary cognitive and attitude theories developed on the concepts derived by Aristotle.

Galileo theory views cognition and cognitive processes as grounded upon "... (an) insight of modern communication theory in that we do not view reality except through the mediation of our system of concepts. The interaction of reality and our concepts makes up

experience. The goal of science is to render 'experience' as orderly, informative and predictable as possible." (Woelfel, 1980).

Woelfel (1980) adopts Mead's (1938) view of behaviour, as a continuing process, necessitating a continuum to represent it fully. Woelfel and Fink (1980) define cognition as a multidimensional time-space continuum within which cognitive processes are predicted by Newtonian principles governing change. The cognitive multidimensional time-space continuum (psychological space), is represented and analysed utilising metric multidimensional scaling. The adoption of Newtonian principles enables the Galileo methodology to focus on the relationships amongst reference concepts rather than just identifying those variables likely to affect behaviour.

The objective of the Galileo measurement system is to identify the set of reference concepts associated with an act, measure the association amongst these concepts to obtain a matrix of inter-concept separations relative to a prespecified 'act' (i.e. high fecundity sheep production system). This matrix is then spatially arrayed utilising metric multidimensional scaling techniques.

4.1.1 Procedures

As discussed in Chapter 3, Galileo methodology identifies the reference concepts by using an in depth interviewing technique where respondents are asked to define and describe the act, whilst the interviewer records and probes responses in an attempt to understand the basis of the response, i.e. the interviewer remains in a passive, non-interactive role. The elicited input and outcome concepts are then aggregated into broad categories representing the reference concepts.

Interconcept distances (separations) are measured utilising direct magnitude estimation techniques, requiring respondents to estimate the distance (as a function of similarity), separating two concepts

using a paired comparison format. Distances are measured at the ratio level of measurement with the origin of the scale set at zero distance, equivalent to total similarity.

Einstein (1961 - cited in Woelfel and Fink, 1980) claimed that to measure a distance you first need a distance which can be employed as a standard measure. In order to enable respondents to measure distances between reference concepts, a standard measure consisting of a given distance between a pair of concepts (criterion concepts), is provided by the researcher. The paired comparison task of Galileo methodology requires $(n+2)(n+1)/2$ non-redundant pairings, whilst the Fishbein and Ajzen model and the attitude as a black box model require $(2n+1)$ and $(n+2)$ responses respectively.

As reliability of a response is inversely proportional to the difficulty of the task (Woelfel and Fink, 1980) any individual measure in a Galileo study may be unreliable due to the difficulty of direct magnitude paired comparison estimates, as the procedure provides virtually no structure and "is consequentially unreliable for measurement of individual psychological contents." (Woelfel and Fink, 1980).

With the assumption that all scale values will be normally distributed about the sample mean, any errors of measurement will be minimised by averaging over the sample or over groups within the sample, increasing the reliability of the measures to provide a matrix of mean interconcept distances.

The mean interconcept distance matrix for the sample, or groups within the sample, involving principal belief, evaluative attitude, overall attitude and peripheral belief measures becomes the input for the subsequent metric multidimensional scaling algorithm which spatially arrays the reference concepts and self concept associated within the domain of the act under study.

4.2.0 MULTIDIMENSIONAL SCALING (MDS)

Multidimensional scaling is the term given to a set of techniques that convert a set of interpoint distances to point co-ordinates within a multidimensional space, such that the inter-point distances within this space optimally reflect the original interpoint distances. (Greenberg and Green, 1974). Optimal in that the spatially arrayed interpoint distances (d_s) are some function of the original interpoint distances (d_i) that minimises the associated error term,

$$\text{i.e. } d_{(s)} = f d_{(i)} + e \quad e = \text{error term.}$$

Typically a MDS problem can be stated as "Given a set of stimuli which vary with respect to an unknown number of dimensions determine a) the minimum dimensionality of the set and b) projections of the stimuli (scale values) on each of the dimensions involved." (Torgerson, 1958).

MDS consists of two distinct models:

- 1) A spatial model, where the theory concerns the characteristics of the multidimensional space, i.e. the dimensionality of the space and the projections of points onto axes of the space.
- 2) A distance model involving a theory relating distances between the points to observable relations between the stimuli. The distance model reflects the distances within the spatial array of points in such a way as to optimally fit the input distances.

4.2.1 Metric - Nonmetric MDS

MDS techniques are categorised on the basis of whether the input data is metric or nonmetric. Metric methods require ratio level distance measures which, when spatially arrayed, provide a set of interpoint distances that are also ratio scaled. Such techniques

are metric in the sense that data obeys the triangular inequality rule, i.e. three points can be said to form a Euclidean triangle if and only if the sum of any two distances does not exceed the third.

Nonmetric techniques convert ordinal dissimilarity data to a configuration in a space of low dimensionality whose interpoint distances are ratio scaled, i.e. where the individual considers the concepts i and j to be more closely associated than the concepts k and l i.e. $S_{ij} > S_{kl}$, the same ordinal relationship, i.e. $d_{ij} > d_{kl}$, where d_{ij} and d_{kl} are ratio scaled distances derived from the spatial representations and S_{ij} and S_{kl} are the distances reported by respondents.

Nonmetric techniques consist of two problems:

- 1) Development of an index of goodness of fit to indicate if the spatial configuration is an appropriate one for representing the input data (i.e. ordinal proximities).
- 2) A procedure for adjusting the points within the configuration to improve the goodness of fit index.

Readers are referred to Kruskal and Wish (1978), and Greenberg and Green (1974) for a full description of nonmetric MDS techniques.

As Galileo methodology uses only metric MDS, the remainder of the discussion in this section is restricted to metric MDS.

4.2.2.0 Metric MDS

4.2.2.1 Distance Models

Torgerson (1958) presented three distance models utilised in MDS - Attneave's city block model, Minkowski metric and the Euclidean, - concluding "the primary contributions of multidimensional scaling would seem to be in those areas where the separate dimensions are

not only not obvious to the subject, but also not even known to the experimenter. In this situation an emphasis on the Euclidean model seems reasonable."

The Euclidean distance function states that the distance between two points is equal to the square root of the sum of squared differences in projections over all orthogonal axes of the space. The advantage of the Euclidean model is that distances remain invariant over a translation or orthogonal rotation of the axes. (Green, 1978; Green and Carroll, 1978).

4.2.2.2 Spatial Models

Spatial models are based upon theorems that derive the projections of a set of points from their interpoint distances. (Young and Householder, 1938) - refer Appendix 1.0.

The Young and Householder theorems derive a symmetric matrix of scalar products - B_i , from the matrix of interpoint distances, with elements b_{jk} - the scalar product of the vectors from point i to points j and k . The origin of B_i being the point i .

Different factoring¹ techniques (transformations) can be applied to the B_i matrix providing co-ordinate sets (A matrices²) which are related to each other via orthogonal rotations of these co-ordinate sets.

Torgerson (1958) centered the B_i matrix of scalar products at the centroid of all points (i.e. centroid of the n -dimensional space), resulting in a unique solution by allowing errors in the interpoint distances to cancel each other out. The Matrix B^* of scalar

¹ Green and Carroll (1978) present the Jacobian and the multiple discriminate analysis transformations.

² The A matrices contain the projections of the points onto a set of orthogonal axes (eigenvectors) with the origin at point i .

products refers to an origin at the centroid of points with elements b_{jk} , where

$$b_{jk} = \frac{1}{2} \left(\frac{1}{n_j} \sum_k d_{jk}^2 + \frac{1}{n_k} \sum_j d_{jk}^2 - \frac{1}{n_j} \sum_k \frac{1}{n_k} \sum_j d_{jk}^2 - d_{jk}^2 \right)$$

4.3.0 GALILEO MULTIDIMENSIONAL SCALING

Galileo utilises a metric MDS technique based upon the matrix (B^*) of scalar products with an origin at the centroid of all points.

4.3.1 Spatial Model

The purpose of the spatial model is to develop a reference frame consisting of a co-ordinate set within which reference concepts are located. Edwards (1933 - cited in Woelfel and Fink, 1980) claimed that "Without a reference system it is impossible to specify just where a body is or how it may be moving."

The B^* matrix is transformed using Jacobian factoring (refer Appendix 1.1) to provide the matrix of eigenvectors (orthogonal dimensions) that maximise the ratio of total sum of squares and cross products of the B^* matrix (SSCP) to the pooled within group SSCP. The first eigenvector represents the dimension accounting for maximum variance, with each subsequent eigenvector representing maximal residual variance and being orthogonal to the previous eigenvector.

The spatial model used by Galileo methodology derives all eigenvectors within the B^* matrix, including those eigenvectors with negative eigenvalues, i.e. since eigenvalues are equal to the sum of the squares of the co-ordinates on each eigenvector, and this sum is negative, the co-ordinates of the reference concepts on these eigenvectors are imaginary. (This is so because the square of an imaginary number is negative, i.e. $i^2 = -1$; Woelfel and Fink, 1980).

Imaginary co-ordinates result from triads of distances not obeying the triangular inequality rule. Traditionally, negative eigenvalues were assumed to be the result of errors of measurement, a problem which was overcome by forcing an Euclidean solution, by a monotone transformation of the original data where the transformation is nonrecoverable, i.e. nonmetric MDS. Woelfel and Fink (1980) argue "Nor is it possible to conclude that this discrepancy is solely the result of random error of measure, since no transformation of these distances within their respective 95% confidence intervals completely eliminates the inconsistency."

4.3.2 Distance Model

To incorporate the imaginary dimensions derived from the spatial model, Galileo theory assumes that human cognition is not strictly Euclidean or metric but displays a degree of inconsistency. Heider (1958) and Festinger (1957) support the concept of inconsistency in that information received by individuals, from which constructs (beliefs and attitudes) are developed, is often inconsistent with existing constructs. Individuals are considered to strive for increased consistency within their construct system, such that observed outcomes will better fit their existing constructs, i.e. existing human thought displays a degree of inconsistency.

To accommodate inconsistency, Galileo methodology utilises a curved Euclidean distance model within which three inconsistent (in a flat Euclidean plane) distances become consistent (see Figure 4.1). Curved Euclidean distance models have a mathematical basis in Riemannian Manifold Mathematics where distances can be calculated using the Pythagorus theorem, if the condition that the metric tensor be positive is relaxed, (Woelfel and Fink, 1980). Where the co-ordinates of any axis are imaginary, the square of the difference between co-ordinates is negative and is equivalent to subtracting the absolute value of the squared difference. (This is possible, as the eigenvectors derived from the Jacobian

transformation are independent of each other, i.e. orthogonal dimensions).

Figure 4:1 Three points on a Rhiemann plane. Triangle ABC need not obey the triangle inequalities rule since curvature of surface allows side BC to take on a value greater than $AB + AC$.

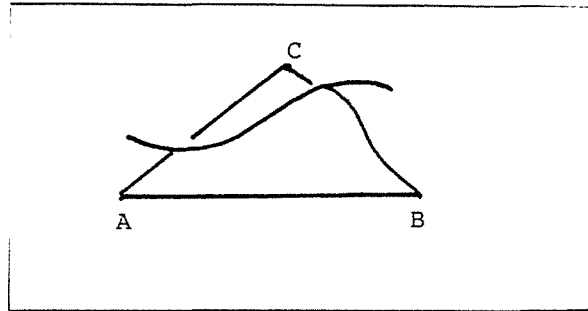

4.3.3 Further Analysis

Having derived a spatial representation of the reference concepts, plus act and self using metric MDS, the co-ordinate set can be utilised to model psychological processes within the domain of the act according to a set of mathematical operations.

Galileo theory assumes the likelihood of behaviour towards an act, as depicted by the overall attitude, is an inverse function of the distance between 'self' and the act. Those reference concepts more closely associated with self are perceived as being more favourable relative to the act, than those not so closely associated. Similarly the reference concepts closely associated with the act are perceived as being an important component of the act.

Within an extension context, the objective is to change the concept-self, concept-act relationships and to predict how these affect the self-act relationship, in order to increase the likelihood of an individual or group of individuals adopting the act (i.e. high fecundity sheep production systems).

Galileo theory considers each reference concept as an information entity, with changes to the position of a concept within the domain of an act being the result of an information input or loss.

Information can be derived from either internal (i.e. consistency forces) or external sources (i.e. observation of the production system outcomes or information received from other individuals). The remainder of this section describes the theory associated with predicting change and the influence of change upon the overall attitude measure.

External information is assumed to exist in the form of messages which are statements of similarity between two or more reference concepts, e.g. an observed outcome is a message in that the individual associates the outcome to a set of inputs.

Messages consisting of only two reference concepts are defined as simple messages, whilst those involving more than two are compound messages. (Woelfel and Fink, 1980).

Galileo theory considers a simple message, e.g. A is B, to create two equal and opposite linear forces, resulting in each concept (A and B) converging along a line segment joining them.

Within an extension context the objective is to derive messages that will move the 'self' and the 'act' concept as close together as possible. This is achieved by depicting the act as the start concept and self as the target concept (or vice versa). To derive the 'optimal message' i.e. the message with the smallest predicted resultant act - self distance, each concept is linked with the start concept, firstly in a pairing, then a 3, 4 and 5 concept association to determine which message combination results in the smallest act - self distance (overall attitude).

Initially the co-ordinate set derived from the MDS (i.e. the matrix of eigenvectors) is recentered such that the origin is at the start concept rather than the centroid of all points³ utilising translations and orthogonal rotations which maintain the interpoint distances. (see Figure 4:2).

³ The recentering is not essential, but is used for ease of calculation.

Figure 4:2 Hypothetical representation of MDS space.

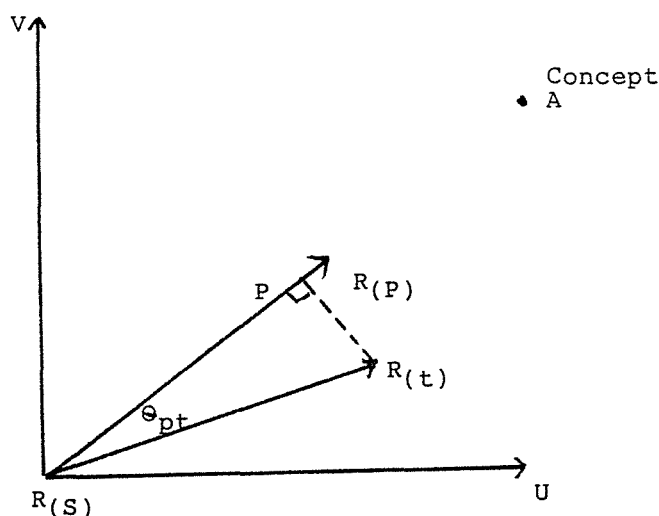

With the objective of moving $R_{(s)}$ start concept along the $R_{(s)}$ - $R_{(t)}$ position vector, the start concept is linked in a simple message with each reference concept, e.g. concept A in Figure 4:2. The predicted response is that $R_{(s)}$ would move along the position vector $R_{(p)}$, such that the overall attitude would be represented by the difference in the two position vectors,

$$\text{i.e. } |R_{(p)} - R_{(t)}| \quad 4.0$$

$$\text{Where } R_{(p)} = |R_{(p)}| = (g_{uv}R_{(p)}R_{(p)})^{1/2} - \text{the length of } R_{(p)} \quad 4.1$$

$$R_{(t)} = |R_{(t)}| = (g_{uv}R_{(t)}R_{(t)})^{1/2} - \text{the length of } R_{(t)} \quad 4.2$$

and where g_{uv} = scalar products of the contravariant basic vectors.

Woelfel and Fink (1980) claim that a 100% successful message is highly unlikely and that the start concept will move only part way along the $R_{(p)}$ vector. Point P (Figure 4.2) represents the closest distance to the target concept that the predicted message can achieve.

The length of the line segment P - R(t) is given by:

$$|PR(t)| = R(t) \sin \theta_{pt} \tag{4:3}$$

where $\theta_{pt} = \cos^{-1}(g_{uv}R(p)R(t)/R(p)R(t))$ 4:4

By determining the concept whose position vector forms the smallest angle with, and provides the smallest distance between R(p) and R(t), the message constituting the start concept and this concept is predicted to be the optimal simple message.

Compound messages require the predicted position vector to be determined, where the underlying assumption is that the simple messages constituting the compound message will average like vectors.

Figure 4:3 Hypothetical representation of a MDS space - compound messages

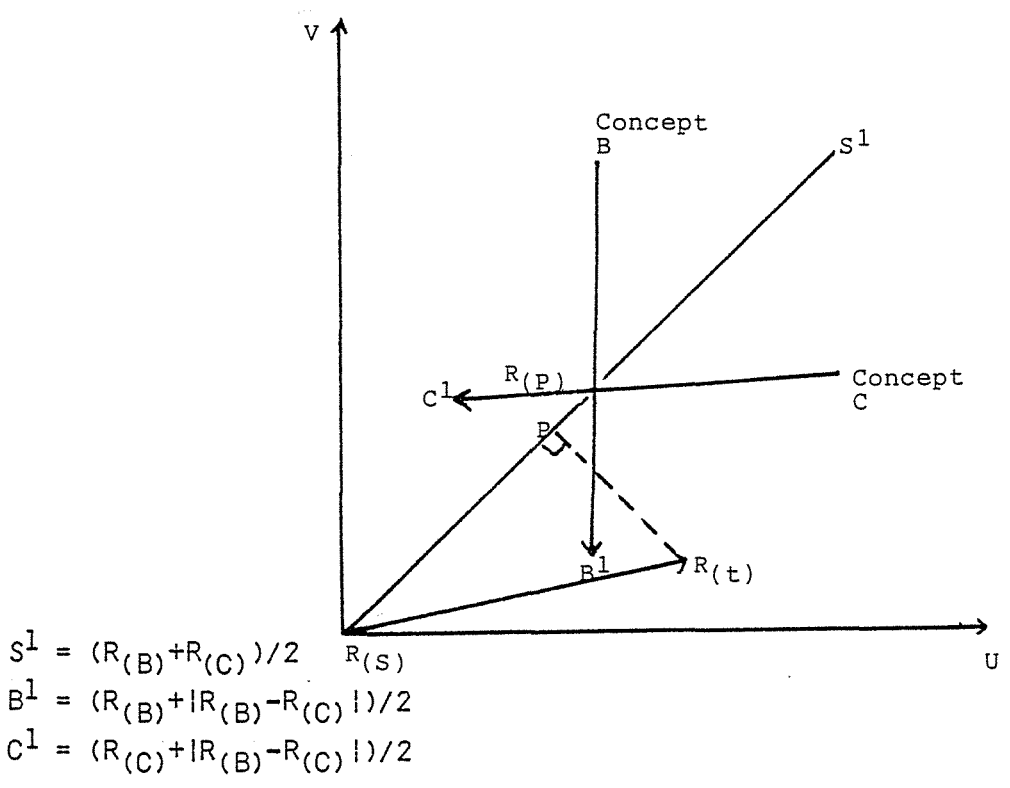

In the simplest form (see Figure 4:3) the compound message "S is B is C" results in the predicted vector $R_{(p)}$ given by:

$$R_{(p)}^u = (R_{(s)}^u + R_{(b)}^u + R_{(c)}^u) / 3 \quad 4.5$$

or more generally as:

$$R_{(p)}^u = \frac{\sum_{i=1}^n R_{(i)}^u}{n} \quad 4.6$$

where R_i^u = position vector of point i on dimension u .

Having derived the predicted vector for each combination of concepts, (the Galileo algorithm combines a maximum of four concepts) equations 4.0 and 4.4 can be utilised to determine the most effective compound message to minimise the overall attitude measure.

The assumptions underlying the generation of messages and the prediction of motion are, viz:

- 1) All concepts have equal inertial mass (resistivity to the forces), i.e. for Figure 4.3 the predicted position vector $R_{(p)}$ represents the centre of volume and mass. With differential inertial mass the $R_{(p)}$ would be at the centre of mass not volume if each component in equation 4.5 was weighted differentially.
- 2) The message forces are instantaneous and independent of the distances involved.
- 3) Other concepts do not "anchor" concepts, i.e. those concepts involved in the message react as if independent to the rest.

- 4) The content and method of delivery of the message are independent of the predicted motions.

To investigate the empirical relationship between the predicted and observed motion of reference concepts as a result of implementing a message, a time series of spatial representations is derived with the observed, predicted and target position vectors quantified and compared using equations 4:0 to 4:6 and vector subtraction principles.

Through time, reference concepts are likely to change position due to the influence of internal and external information sources. To compare co-ordinate sets requires a common reference point (origin) for all co-ordinate sets. Woelfel and Fink (1980) recommend that the researcher identify a subset of concepts that display similar inter-relationships with each other throughout the time series (i.e. the interpoint distances between these concepts remain invariant). The centroid of this invariant subset of concepts is then used as the origin for the respective co-ordinate sets, ensuring that any change in the position vector of a concept is attributed to 'actual' motion rather than motion created by the co-ordinate systems origin moving.

Having identified an origin common to all co-ordinate sets, the different co-ordinate sets need to be transformed onto a single common co-ordinate system to enable comparisons to be made. Galileo theory uses 'Procrustes rotations' (Korth and Tucker, 1976; Gower, 1975) to achieve a common co-ordinate system. Procrustes rotations consist of orthogonal rotations of the co-ordinates of one dataset (i.e. set A) onto the co-ordinates of another dataset (i.e. set B). Schonemann (1966) stated that Procrustes rotations consist of "The least-squares problem of transforming a given matrix A into a given matrix B by an orthogonal transformation matrix T so that the sums of squares of the residual matrix $E = AT - B$ is a minimum ..."

Mathematically, the Procrustes problem can be stated as $AT = B + E$. Within a message evaluation context, the two matrices need to be

partitioned into those concepts likely to move (those included or implicated by the message) and those that are not. Those concepts not involved are predicted to remain stable over time, i.e. invariant concepts (apart from the changes that occur due to influences other than from the message). The stable concepts in both matrices are rotated onto a single co-ordinate system, minimising the least squares criterion with the transformation - say (T). The remaining concepts are then transformed by using the same transformation (T) but without a 'best fit' criteria, i.e. $AT = B$. Having both matrices (co-ordinate sets) on the same co-ordinate system allows the measurement of motion by applying vector subtraction principles and equations 4.0 to 4.6 to the observed, predicted and target position vectors.

To measure differences in cognitive structure across groups within the sample, procrustes rotations can also be utilised in a similar manner to the time series approach outlined. Woelfel and Fink, (1980) do not make any recommendation as to how the stable concepts may be selected, which is a problem in that the researcher is unlikely to have a knowledge of which concepts truly differ and those that do not within a cross sectional research study design.

4.4.0 GALILEO METHODOLOGY : SUMMARY

Galileo methodology is a research system design for quantifying and analysing cognitive relationships and processes, based upon a high degree of precision in the collection and measurement of belief and attitude relationships, through the use of the real number system for direct magnitude estimation at a ratio level of measurement.

Belief and attitude measures are then spatially arrayed using metric multidimensional scaling techniques which are based on a curved Euclidean (i.e. Rhiemann manifold) distance model, to incorporate inconsistencies that exist within human thoughts.

Messages linking two or more concepts are assumed to produce linear forces which can be represented by position vectors and vector algebra used to predict cognitive change within the domain of an act. Procrustes rotations were described and defined as being useful in that different co-ordinate sets can be rotated onto each other enabling differences to be measured.

4.5.0 MULTIPLE DISCRIMINANT ANALYSIS (MDA)

MDA is utilised in this study to represent how principal beliefs, evaluative attitudes and the overall attitude, as defined by the Fishbein and Ajzen model of reasoned action, are utilised to characterise between managers with and without experience of fecundity production systems and a group of experts.

MDA was developed with the purpose of classification, originally into one of two separate groups, and subsequently extended to classify over any number of groups in order to study group differences on several variables (concepts) simultaneously.

Green and Tull (1978), Green and Carroll (1976) list the objectives of discriminant analysis as being, viz:

- 1) Developing linear composites of the independent variables enabling the researcher to separate groups maximising the ratio of among groups to within groups variation.
- 2) To establish a criterion by which to assign new individuals to a group, when the level of input - outcome is known, but the group not.
- 3) Testing for significant differences between the mean predictor variable profile for separate groups.
- 4) To determine which variables account for the most intergroup difference in mean profiles.

In this study MDA is applied to a three way matrix of groups (Inexperienced, Experienced and Expert - depicted by dummy variables reflecting an experience of high fecundity or not) by independent variables (input - outcome associations) by respondents, with the aim of developing linear composites (discriminant functions) of the independent variables (beliefs or evaluative attitudes and overall attitudes) relative to either the Act or self.

The basic aim of this analysis being to derive a set of weights (discriminant coefficients) that when applied to the independent variables will maximise the ratio of between groups Sums of Squares and Cross Products (SSCP) to pooled within group SSCP¹³. The resulting function takes the form:

$$Z_i = b_0 + b_1X_{1i} + b_2X_{2i} = \dots b_nX_{ni} \quad 4.7$$

where X_{ji} is the i^{th} individual value of the j^{th} independent variable.

b_j is the discriminant coefficient of the j^{th} variable.

z_i is the i^{th} discriminant score.

The number of discriminating functions which can be derived is either one less than the number of groups or equal to the number of discriminating variables if there are more groups than variables (Klecka, 1980).

¹³ MDA partitions the total variance of the independent variables into within and between group variance, with the resultant composite maximising the ratio i

where $i = \frac{SSA(W_1)}{SSA(W_1)(W_2)}$ refer to Appendix 3.2 for the derivation of i .

4.5.1 Graphical Representation

If there are three or more groups, a n - dimensional plot (where n = the number of discriminant functions) of each data case can be prepared. (Green and Tull, 1978; Klecka, 1980). The discriminant functions are plotted through an origin located at the grand centroid (sample centroid) and the orthogonal plotting of these functions achieves maximal separation. Group means (mean within group discriminant score) can also be located within the dimensions defined by the population enabling the researcher to identify the basis of discrimination.

The independent variables can be plotted (utilising the b_j values) where the direction and length (in absolute terms) of the vectors reflect the basis on which the groups are discriminated, and can be utilised to interpret the discriminant functions.

Conceptually, MDA differs from MDS in that MDA locates x objects (Experienced, Inexperienced and Expert groups) within an $(X-1)$ dimensional space, whilst MDS locates $(n+2)$ points within a $(n+2)$ dimensional space where $(n+2)$ equals the number of reference concepts plus 'self' and the act.

4.6.0 MULTIPLE REGRESSION

Multiple regression attempts to predict the value of a criterion variable Y , (a measure of the overall attitude obtained from the Galileo analysis) by developing a linear composite (equation 4.8) of the independent variables according to a least squares criterion, specifically minimising the sum of squared errors $(\hat{Y}_i - Y_i)^2$

$$\hat{Y} = b_0 + b_1X_1 + b_2X_2 + \dots + b_nX_n \quad 4.8$$

Where \hat{Y} = estimator of the criterion variable Y , b_0 , b_1 , etc = regression coefficients or Beta weights for the independent

variable that minimise the sum of squared errors.
 X_1, X_2 , etc = predictor or independent variables.

Kim and Kahout (1979 - cited in Nie et al, 1974) listed three objectives of multiple regression analysis as a descriptive - predictive tool as being:

- 1) To find the best linear prediction equation and evaluate its prediction accuracy.
- 2) To control other confounding factors in order to evaluate the contribution of a specific variable or set of variables.
- 3) To find structural relations and provide explanations of seemingly complex multivariate relationships.

Multiple regression is utilised in this study to provide Beta weights which when applied to the independent variables, i.e. the Galileo concepts, would result in the optimal prediction (from these concepts, for this sample) of the overall attitude measure as obtained from the Galileo study, i.e. the Self - High fecundity distance will be the criterion variable Y in the derivation of the Beta weights.

4.7.0 SUMMARY

Chapter 4 presented the measurement system used by Galileo methodology to obtain a matrix of mean interconcept distances, as representative of the belief and attitude relationships associated with an act. Specifically, the Galileo methodology uses in-depth interviews to elicit reference concepts and open ended scales, at a ratio level of measurement, to accurately determine the beliefs and attitude relationships within a paired comparison format. Multidimensional scaling was introduced and described as a multivariate technique which arrays n points within a n -

dimensional space, minimising any distortion of cognitive relationships as depicted in the matrix of interconcept distances. The use of MDS by Galileo methodology, based upon a curved Euclidean (Rhiemann manifold) distance model to account for inconsistency in human thought was discussed. The Pythagoras theorem as used to derive measures of interpoint distances within the Rhiemann Manifold was shown to be possible if the real and imaginary dimensions were treated as being independent of each other.

Procrustes rotations consisting of orthogonal rotations of two matrices (co-ordinate sets) onto a common co-ordinate system was utilised to enable the comparison of two co-ordinate systems from either across time for the same individuals, i.e. message evaluation, or across groups, i.e. increase understanding of cognitive relationships within a sample of individuals.

Finally the multivariate techniques of multiple discriminant analysis and multiple regression were described as being appropriate techniques for analysing the input data used by the Fishbein and Ajzen model taken from the Galileo data set. Multiple Discriminant Analysis determines how differing groups within the sample can be discriminated on the basis of overall and evaluative attitude and principal belief measures. Multiple regression enables the researcher to estimate the contribution of each reference concept to the overall attitude measure.

CHAPTER FIVE : STUDY AREA AND RESPONDENTS

5.0.0 INTRODUCTION

Farmers in the western Dannevirke statistical area (see Figure 5:1) were chosen as respondents in this study of soft systems research methodology, due to their convenient location relative to Massey University. This chapter gives a general introduction to farming conditions and systems in this region.

The results of a preliminary survey of Ministry of Agriculture and Fisheries (MAF) class five farm monitoring properties in this region are presented to identify and provide insight into the management components of high, medium and low, lambing performance production systems.

5.1.0 STUDY AREA

Within the Dannevirke statistical area the predominant land use (1982 - 1983)¹ was sheep and cattle (78% of all properties). Over recent years dairy cow numbers have increased with sheep and beef numbers declining (Dept of Statistics, 1983), due to the lower relative returns from traditional beef production systems compared with sheep production (McNeil et al, 1985). The climate of the region is largely influenced by the Ruahine range and the Manawatu river gorge. The Manawatu river gorge reduces the sheltering effect of the Ruahine range by tunnelling the westerley wind flows onto the study region resulting in a predominance of westerley and southwesterly winds during spring (deLisle and Paterson, 1971).

The level and distribution of rainfall is influenced by the rain shadow effect of the Ruahine range and the predominant windflows,

1 Department of Statistics. Agricultural Statistics 1982/83.

Figure 5:1 Study Area

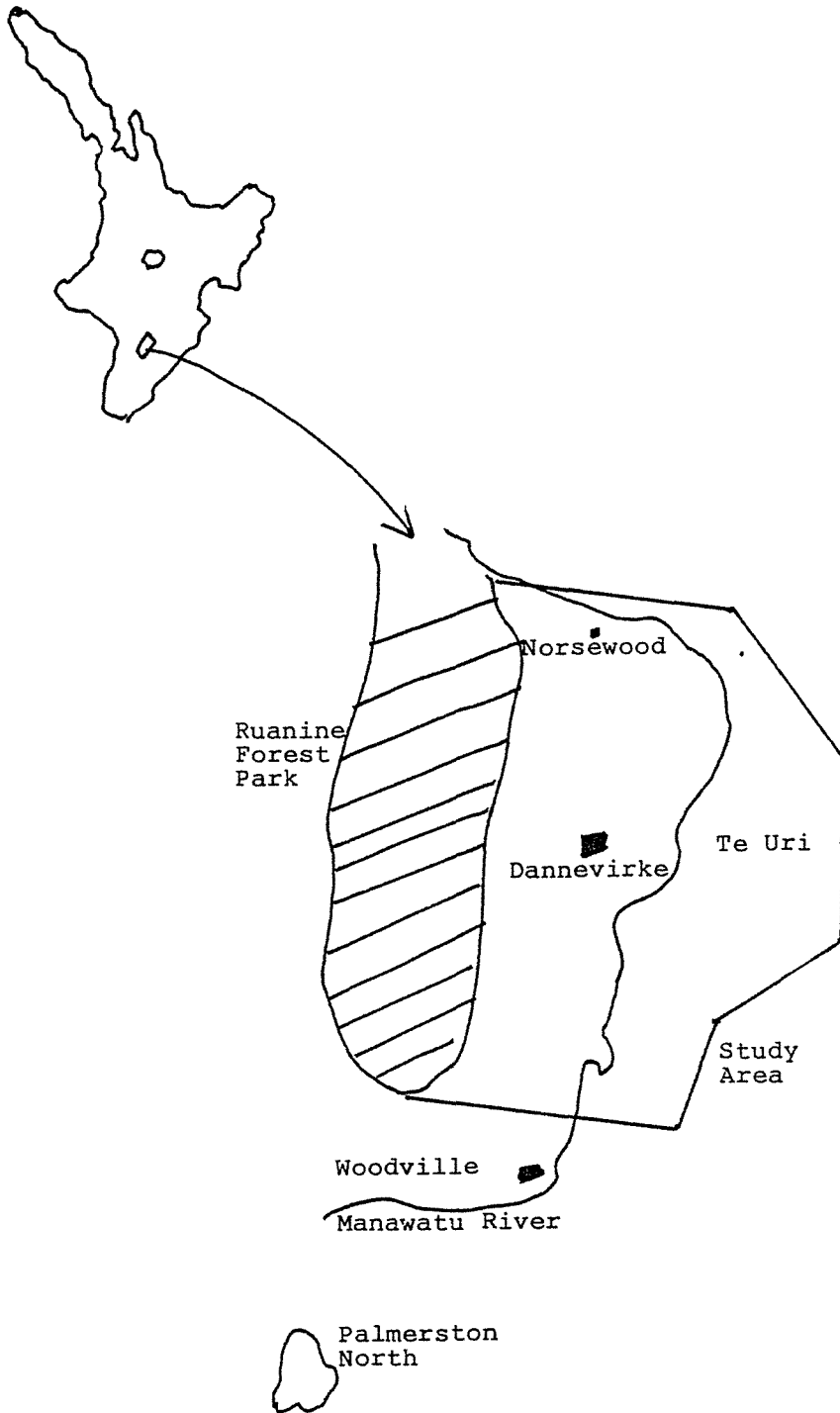

with the eastern and western boundaries of the study area receiving on average 1000 mm and 2500 mm per annum respectively. Dannevirke township receives a mean annual rainfall of 1093 mm, with the likelihood of summer drought increasing in an easterly direction.

Pasture production data for the northern Waiararapa/ Southern Hawkes Bay region is presented in Table 5:1. Based on 46 observations over 13 sites (for four years) total annual production averages 9988 kilograms dry matter per hectare (kg DM/ha) ranging from 6548 to 12352 kg DM/ha/yr.

Growth rates reach a maximum during November with a minimum in July. The spring period displays the greatest variability reflecting the effect of rainfall and temperature variation.

Soils within the study area are most suited for pastoral uses, with the high producing central yellow brown earths and yellow brown integrades capable of supporting intensive dairying. The remaining soils are only moderately fertile being most suited for breeding and fattening enterprises, with only small areas suited to horticulture and arable land use (Luke, 1968).

The study area can be described as comprising of flat top ridges running in an east-west direction on either side of the Manawatu river. Properties are on the whole, flat to rolling with steep faces associated with the Manawatu river and the eastern and western hill ranges.

5.2.0 CLASS FIVE PROPERTIES

The study area was selected to incorporate the MAF, Advisory Services Division (ASD) class five farm monitoring properties within the Dannevirke statistical area. Class five properties are defined as being "high producing grassland farms mainly in Manawatu/Rangitikei, Waikato, Hawkes Bay ... with a wide range of

stock policies and often some crop" (MAF, 1984). Within the study area, class five properties were selected on the basis of having similar potential carrying capacity (18 - 22 su/ha) with a minimum of physical constraints (this was thought likely to increase the acceptance of the research compared with say hill country where high fecundity may be considered as irrelevant and impractical.) The national modal class five property consists of 161 hectares with up to 10% in arable crop, carrying 2565 stock units (73% breeding ewes and 14% cattle). Lambing percentages are in the range of 100 - 110% with wool weights averaging approximately 5.2 kg per sheep stock unit (ssu).

The ASD Dannevirke region incorporates a total of 260 class five properties, generally located in the higher rainfall areas associated with the Ruahine and Tararua ranges. The Dannevirke region class five modal farm consists of 259 hectares with no cash cropping, running 3366 su at a lambing percentage of 104% and producing 5.5 kg wool per ssu.

5.3.0 PERFORMANCE SURVEY

A mail survey was used to identify class five properties within the study area and to obtain physical and production data on these properties. This information was used to stratify the study farms on the basis of lambing performance, enabling the reference concept elicitation interview respondents to be selected from the widest possible range of performance levels as recommended by Woelfel et al (1977).

A total of 163 class five properties were identified throughout the study area by local farm advisory staff. The initial survey (see appendix 5:1) was mailed during April 1985, with the objective of obtaining a limited amount of basic information on stock numbers and performance levels for the past three years (ie the 1982 - 1983, 1983 - 1984, 1984 - 1985) years.

Survey farmers were sent an introductory letter outlining the research objectives, what was required of respondents and that this research was primarily evaluating a new methodology. Also included were instructions which defined the terminology used and a return post-paid envelope. A reminder notice was mailed along with a duplicate survey form and instructions to those respondents which had failed after one month to return the initial survey as recommended by Bourke (1978).

Seven surveys failed to find the respondent, resulting in a total of 156 surveys being delivered. One hundred and twenty four (124) returns (79.5%) were returned of which 23 returns (14.7%) were either uncompleted or only partially completed. The two most common reasons for not completing the survey were the author's association with the MAF's advisory division (4 respondents) and the wrongful assumption that the research was directly associated with the commercial product Fecundin² which was considered to be "too costly", "a waste of time", "impractical" (nine respondents). A total of 101 completed surveys (64.7%) were returned.

As the purpose of the initial interview was to identify which respondents were achieving high, medium or low lambing performance, the sample was stratified on the basis of the average lambing percentage achieved for the three years.

The three strata were defined as viz:

- 1) High (H) group which included those respondents with an average lambing percentage of 116% LW/EJ³. Rohloff (1983) defined flocks with the potential of 140% LB/EJ as high fecundity because greater than 50% of lambs are born as multiples, requiring the adoption of specific management techniques to successfully cope with multiple lambs.

2 Fecundin - trade name (Glaxo NZ Ltd) used for the active immunisation of ewes for fecundity - see Smith (1983, 1984).

3 LW/EJ = lambs weaned per ewe joined where 116% LW/EJ on average equates to 140% LB/EJ. (Lambs born per ewe joined) - Smith 1983.

- 2) Low (L) group which included those respondents with an average lambing percentage of less than 100% LE/EJ as such flocks have a majority of single lambs and should therefore be managed accordingly. Rohloff (1983); Davis, Rohloff and Kelly (1985).
- 3) Medium (M) group which includes those respondents with an average lambing percentage between 100% and 116% LW/EJ.

Table 5:2 presents the results of the initial survey and the stratification of the sample for the 1984 year into the H, M, L groups.

5.3.1 Survey Results

The average of the farms surveyed comprised 282.4 ha of which approximately 50% was classified as rolling (ie cultivatable but not flat), with the remainder evenly split between flat and steep (not cultivatable). With increasing fecundity levels, properties and breeding ewe flocks tend to be smaller (H group averaged 202 ha running 1581 breeding ewes cf the L group averaged 351 ha running 2519 breeding ewes). High group properties (22) have a higher proportion of rolling (53%) and flat (35%) than the medium (48%) and low (31%) groups.

The study area properties are slightly smaller than those reported for the Dannevirke class five modal property. Figure 5:2 presents the location of the 101 respondents within the study area, identifying the three performance strata. High group properties are located on the western and northern districts, with the medium group properties located over the whole study area. Low performance properties tend to be located on the eastern side of the state highway two.

Table 5:2 Performance Survey Results (Standard Error of Mean)

Variable	1982	1983	1984	High	Medium	Low
Farm size (ha)			282.4 (21.4)	202.7 (27.3)	274.5 (35.2)	350.9 (36.2)
% Steep			27.6 (2.6)	12.0 (2.3)	24.1 (3.5)	43.1 (4.8)
% Rolling			48.6 (2.5)	53.06 (6.4)	49.9 (3.6)	43.9 (3.78)
% Flat			23.8 (2.7)	34.9 (6.9)	25.9 (3.8)	13.0 (3.2)
Ewe Numbers	2109 (153)	2192 (152)	2176 (137)	1581 (189.6)	2227 (224.4)	2519 (227.9)
Repl. Hoggets	654 (51)	680 (54)	675 (48)	458 (75.7)	712 (78.8)	778 (76.5)
Other Sheep	85.7 (13.4)	100.7 (15.3)	119.1 (27.4)	103.7 (16.7)	121.2 (28.3)	123.7 (32.1)
Breeding Cows	26.6 (5.7)	29.5 (6.3)	30.7 (6.3)	20.4 (7.8)	33.9 (11.7)	33.4 (9.3)
Other Cattle	77.4 (7.9)	78.9 (8.6)	91.9 (10.9)	74.27 (15.3)	86.9 (12.8)	111.7 (27)
Total Stock Units	3134.7	3273.0	3328.7	2825.0	3516.0	3853.0
Sheep Stock Unit	2626.8	2738.0	2731.0	2369.0	2921.0	3150.0
Cattle Stock Unit	507.9	535.5	597.8	457.0	595.0	703.0
Sheep/Cattle Ratio	5.17	4.11	5.56	5.19	4.92	4.48
Lambing (LW/EJ)	106.3 (1.6)	104.9 (1.6)	109.2 (1.3)	125.5 (1.8)	110.5 (1.07)	95.8 (1.69)
Stocking Rate	11.1	11.6	11.71	13.91	12.82	10.97

Figure 5:2 Distribution of Lambing Performance and Location of Study Sample Throughout the Study Area

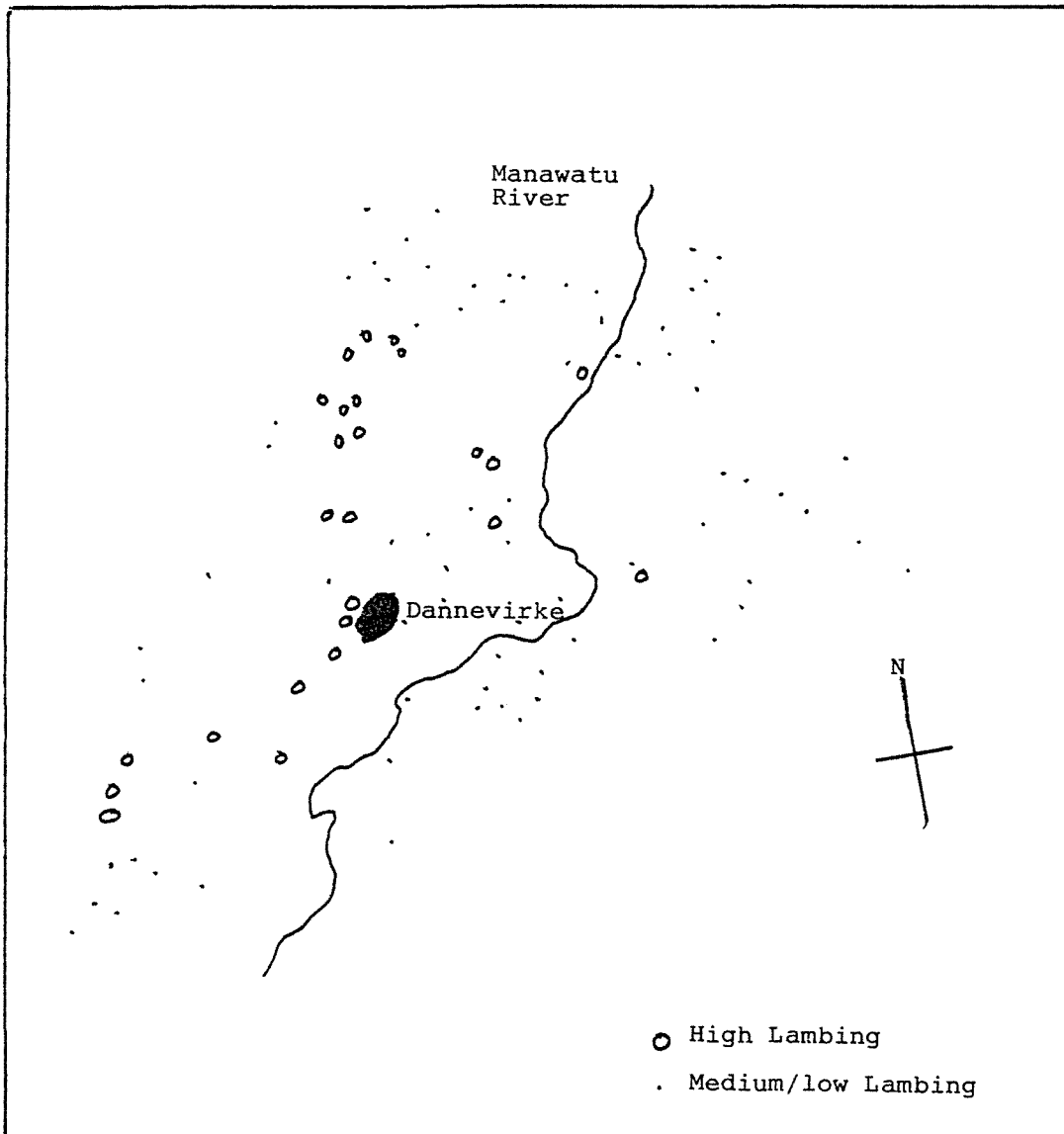

Sheep numbers increased over the three year period as did cattle numbers. The high group ran fewer breeding ewes and cows than the medium and low groups.

The sheep/cattle ratio increased slightly over the first three years, with the high group having a higher sheep/cattle ratio than the medium low groups.

Stocking rates increased by 0.6 su/ha over the three years and increase with the level of average lambing performance (ie H group 13.91 su/ha; L group 10.97 su/ha).

Lambing percentages for the three years averaged 106.8% LW/EJ, with the Low and Medium groups reporting the lowest lambing percentage in 1983, which was the maximum percentage for the high group. Performance levels (lambs weaned per ewe joined) for the study region are compared with those reported for the Dannevirke county, McNeil et al, (1985), MAF (1985) in Table 5:3.

Table 5:3 Comparative Lambing Performance Levels (LW/EJ)

Year	Study Area Farms	McNeil (1) et al	Dannevirke (2) County	M.A.F. (3)
1982	106.3		91	107
1983	105		102	100
1984	109.2			108
Average	106.8	105.3		105

(1) - McNeil et al (1985). Taken from the evaluation of the Dannevirke Planned Animal Health Advisory Programme (PAHAPS)

(2) - Agricultural Statistics, 1985.

(3) - MAF Farm Monitoring Model.

The study area has a higher performance level than for the Dannevirke county which incorporates class three and four farms (North Island hill and hard hill country) which are steeper, more extensive and subsequently lower performance properties. McNeil et al, (1985) reported a mean lambing percentage of 105.3% for the 1980 to 1982 period which was slightly lower than the mean lambing percentage reported for the study area (106.8 LW/EJ). In relation to the national class five modal property the study region has a marginally higher lambing percentage but without the large yearly variation.

Table 5:1 Monthly Pasture Growth Rates (kg DM/ha) and Total Annual Production (kgDM/ha).
Boyle pers comm.

Site (Yrs of Obser)	Jan	Feb	Mar	Apr	May	Jun	Jul	Aug	Sep	Oct	Nov	Dec	TOTAL
One (4)	38.5	37.0	32.8	28.3	18.3	12.8	10.3	15.5	28.8	49.5	56.3	57.0	11690
Two (4)	29.3	29.0	23.5	26.8	12.8	11.8	9.8	15.5	23.0	47.5	54.3	47.8	10051
Three (2)	20.0	30.0	24.5	19.0	11.5	10.0	11.0	12.0	27.5	39.0	47.5	49.5	9153
Four (2)	32.5	33.0	37.5	26.0	19.0	9.0	12.0	15.5	34.5	42.0	38.0	43.5	10411
Five (4)	17.8	23.5	22.5	25.8	15.3	8.8	6.8	11.5	28.5	47.3	58.5	31.5	9031
Six (4)	44.0	38.0	34.5	25.3	12.3	8.0	5.5	9.3	22.0	35.5	51.3	45.3	10033
Seven (4)	25.5	24.8	30.0	24.0	11.3	6.8	3.3	3.3	9.5	20.8	26.0	30.8	6548
Eight (4)	38.3	36.0	34.8	28.3	14.0	9.5	8.3	11.8	21.0	28.8	45.5	43.8	9700
Nine (3)	30.3	39.7	41.0	24.7	19.3	15.0	13.0	24.7	43.0	49.0	61.3	44.3	1230
Ten (3)	9.0	24.3	38.3	26.7	15.7	12.3	9.7	19.3	35.7	52.7	55.7	38.0	10254
Eleven (4)	22.3	33.5	37.3	27.3	19.0	15.5	10.0	13.8	38.5	60.8	75.3	53.8	12352
Twelve (4)	24.5	18.5	24.0	18.0	12.0	8.5	5.5	8.5	18.0	34.0	42.8	38.5	7693
Thirteen (4)	24.5	18.5	24.0	18.0	12.0	8.5	5.5	8.5	18.0	34.0	42.8	38.5	7693
Mean	28.6	30.35	30.82	24.88	14.91	11.54	8.82	13.86	27.48	42.17	51.29	44.41	9988
SD	10.06	6.55	7.11	3.21	3.07	4.12	2.81	5.47	9.07	10.69	11.99	8.15	1666
SE	2.79	0.26	1.97	.89	.85	1.14	.78	1.52	2.52	2.96	3.33	2.26	462

5.4.0 SUMMARY

In this chapter the western Dannevirke statistical area was presented as the study area from which class five MAF ASD farm monitoring properties were selected as the respondents for this soft system research study. The study area receives a reliable summer rainfall on average with a higher than normal windrun predominantly from the west to southwest in the southern areas. The soils are most suited for pastoral uses, with sheep and cattle enterprises constituting the largest proportion.

One hundred and one replies to an initial survey were used to obtain information on the performance levels, so that respondents could be stratified on the basis of average lambing percentage for the three years from 1982 to 1984. The strata were High (above 116% LW/EJ), Low (below 100% LW/EJ) and medium (100% - 116% LW/EJ).

Properties with increasing fecundity levels were associated with decreasing farm size, a reduced proportion of steep land, running fewer breeding ewes, but at a higher stocking rate. These results are consistent with the findings of Rohloff (1981) in a survey of high fecundity properties located in Southland (NZ). Chapter 6 presents a summary of the important components of high fecundity and defines the act for the reference concept elicitation interviews of farmers selected from the three lambing percentage strata discussed in chapter 5.

CHAPTER SIX : HIGH FECUNDITY PRODUCTION SYSTEMS

6.0.0 INTRODUCTION

Chapter 6 defines the act that was used to investigate the cognitive structure of respondents selected from the survey farms described in chapter five.

Having defined the act, literature relating to the management of high fecundity is then reviewed, along with literature specifically relating to the major components of high fecundity production systems, viz.

- (1) Multiple Lamb Survival
- (2) Multiple Lamb Growth Rates

The components of multiple lamb survival and growth rates are considered to be the crucial components in the successful achievement of high fecundity production systems.

6.1.0 HIGH FECUNDITY

Fecundity is defined as being fecund, ie prolific (Concise Oxford Dictionary, 1964) which is expanded to the number of eggs available for fertilisation per ewe and is reflected in the number of progeny born per ewe mated.

Fertility is the number of ewes ovulating in the flock and is reflected in the number of ewes mated per ewes present at mating.

Owens (1984, 1985), Rohloff (1984) define high fecundity flocks as those flocks with the potential to achieve 140% lambs born per ewe mated, as such flocks have a higher proportion of multiple than single birth lambs. Black (1985) considered the objective of a high fecundity management system to be the ability to produce high meat output per hectare at weaning.

The overall definition used for this study was - that successful high fecundity management involves maximising meat output per hectares for flocks with a potential to achieve at least 140% lambs born per ewe mated (LB/EM).

Several alternatives are available to achieve high fecundity production levels viz:

- 1) Through selection pressure on the existing ewe flocks for increased twinning rates. (Clarke, 1972; Dalton and Rae, 1979).
- 2) The achievement of higher tupping weights can be used to increase lambing percentages. (Parker et al, 1975; Kelly, 1978; Allison and Kelly, 1978; Parker, 1984).
- 3) Immunisation using steriod hormones with an average increase in fecundity levels of 20 - 22% (range 4 - 48%) (Smith, 1983).
- 4) Crossbreeding to transfer the Booroola gene into the existing ewe flock, results in each carrier ewe dropping an average of one extra lamb. (Davis, 1985; Davis et al, 1981).
- 5) The likely release of the Finn breed also offers an alternative to increase lambing percentages. (Davis, 1983(b)).

Literature on high fecundity management, (Owens, 1984; 1985; Rohloff, 1981; 1984; 1985; Davis 1985) claim that a successful management system should be oriented towards the survival and growth rates of lambs born as multiples in order to maximise the weight of lambs weaned per ewe.

The remainder of this section summarises the factors influencing the survival and growth rates of multiple lambs until weaning.¹

¹ Other sheep production and management system components are reviewed by Parker (1984).

6.2.0 MULTIPLE LAMB SURVIVAL

Flocks of average fecundity involve lamb mortality rates from 3% to 25% (Hight and Jury, 1970; Meyer and Clarke, 1978; Duff, 1981 - a review). For high fecundity flocks, mortality rates average 40 percent with 21, 50 and 60 percent of twin, triplet and quad. lambs dying respectively, (Hinch, 1983(a); Owens, 1984; 1985).

In the only reported study of commercial high fecundity sheep flocks, Rohloff and Hinch, (1983) reported an average mortality rate of 7.9% (range 4.2 to 8.9%) for flocks in Southland (NZ) with litter sizes ranging from 1.8 to 2.08 lambs per ewe - significantly lower mortality rates than reported from research trials.

6.2.1 Birthweight

The influence of birthweight on survival rates is illustrated in Figure 6:1. Hight and Jury (1970); Dalton et al (1980) reported that lamb survival rates were maximum (at approximately 85 - 90 percent) for the birthweight range : 3.5 - 5.0 kg.

Figure 6:1 Impact of Birthweight of Lambs on the Number of Lambs Weaned/Lambs Born

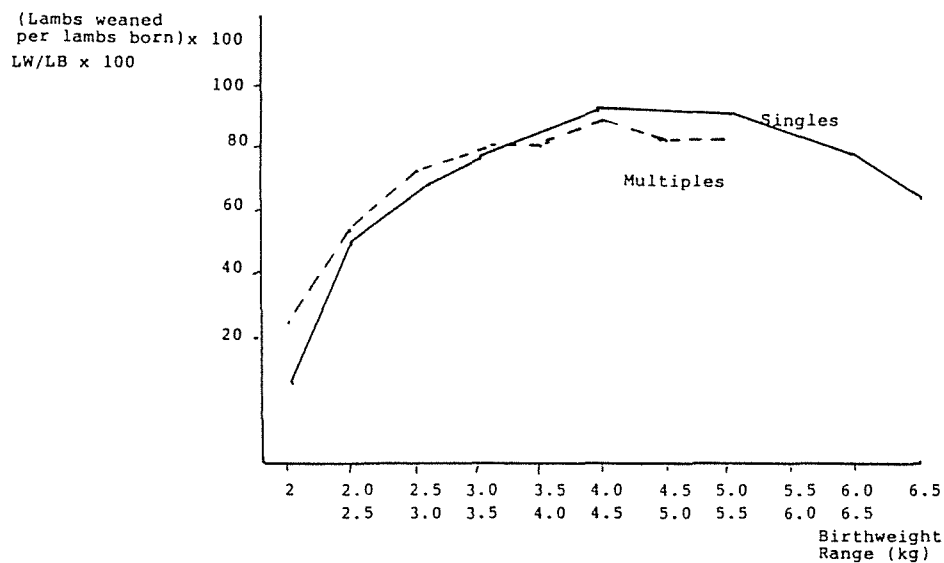

The causes of lamb mortality are well documented (Hight and Jury, 1970; Dalton, 1980; McCutcheon et al, 1981; Duff, 1981 - a review). The two main causes being viz:

- 1) Dystocia, ie long and difficult parturition due to high birthweights and/or a narrow pelvic opening, resulting in injury to the lamb or ewe. (McSporran, 1975). Dystocia is associated with larger single lambs (greater than 5.0 kg) accounting for 45% of single lamb mortality (Dalton, 1980). The high birthweights result in major central nervous system damage causing death. (Duff, 1981 - a review).
- 2) Starvation - Exposure deaths (S-E Syndrome), ie the inability of the lamb to increase heat production resulting in a drop in deep body temperature - hypothermic condition.

S-E syndrome deaths account for 42 percent of twin lamb deaths (Dalton, 1980), which, because of their high surface area to volume ratio, lose heat faster and have lower body reserves to utilise for heat production.

6.2.2 Starvation - Exposure Deaths

S-E syndrome occurs when heat loss exceeds the potential heat production (summit metabolism) of the lamb. To minimise S-E deaths either heat loss should be reduced or heat production increased.

Heat production is increased via shivering, burning of body reserves (ie brownfat) and suckling. However, as the deep body temperature falls the body reserves are utilised the suckling drive is also reduced compounding the hypothermic effects. (McCutcheon et al, 1983; Wallace, 1948).

McCutcheon, (1981) demonstrated that lambs vary in their ability to produce heat, although the variation was not the result of breed effects.

Heat losses are minimised by vasoconstriction (Haughey, 1983) and are associated with birthcoat type (Slee, 1978), birthweight and weather influences (Sykes et al, 1976).

McCutcheon (1983(a)) demonstrated that wet lambs in windy conditions over-compensated for the rate of heat loss, reaching summit metabolism at 15°C whilst dry lambs maintained body temperatures to freezing point. This effect is compounded by the inhibition of suckling at low ambient temperatures, ie 60% of lambs fail to suckle at 10°C with 5% failing at 28°C. Duff (1981) related this inhibition to minor CNS damage associated with the spinal meninges.

Duff, (1981); Hinch, (1983(a)); Rohloff, (1983) recommend the provision of an appropriate environment to minimise the influence of weather or heat loss. Bird, et al (1984) reported that twin

mortality rates dropped by up to 37% with the provision of intensive shelter.

Mismothering, resulting in lambs being separated from ewes, contributes to S-E syndrome. Kilgour (1982) demonstrated that the establishment of a birthsite by the ewe prior to lambing was important in creating a bond between the dam and offspring, with the dam returning to the birthsite after being separated from her lambs. Managers of high fecundity flocks favour set stocking at lambing time, enabling a birthsite to be established. (Rohloff, 1981). In addition, increased shepherding intensity may also reduce mismothering, and increased survival obtained with the fostering of lambs. Both practices are used more extensively by managers in a high fecundity situation. (Rohloff, 1981).

Knight et al (1983, 1984) claimed that slopes of greater than 24 degrees resulted in higher twin lamb mortality due to lambs (one or both) slipping from the birthsite in different directions and distances.

Lambing multiple-carrying ewes on flat ground under set stocking, enables environmental factors contributing to S-E syndrome deaths to be minimised via intensive shepherding and the provision of shelter.

The manipulation of birthweights into the 3.5 to 5.0 kg safe range offers the greatest opportunity to minimise S-E syndrome deaths. Ewe tupping weight and mature ewe size are associated with lamb birthweights, (Starke et al 1958; Alexander, 1974; Donald and Russell, 1970), with liveweights of over 50 kg necessary to achieve twin lamb birthweights in the 3.5 to 5.0 kg range. (Rohloff, 1984).

6.2.3 Nutritional Influence on Birthweights

Ewe nutrition has the largest influence on lamb birthweight, with 70% of foetal growth occurring in the last 5 to 6 weeks of pregnancy. Rattray and Trigg (1979) demonstrated that twin lamb

birthweights could be increased by up to 0.5 kg, whilst Khalaf et al (1979) increased triplet birthweights by 30%, through late pregnancy feeding. Late pregnancy under-nutrition reduced birthweights, ewe body condition and subsequent lactation performance (Hinch, 1983 (b)).

Meschia (cited in Davis et al, 1981) reported that foetal growth was a function of the nutrient concentration gradient between the ewe and lamb, implying the size, number and surface area of placental cotyledons may influence the ability to manipulate birthweights via nutrition.

Placental growth occurs in the first 100 days of pregnancy with a 5% ewe weight loss over this period reducing placental and subsequent foetal growth. (Robinson (1983) - see Figure 6:2).

Figure 6:2 The Effects of Undernutrition during the Second and Third Months of Prenancy on the Size of the Placentae and Foetuses at Day 90 of Gestation (from data reviewed by Robinson 1983)

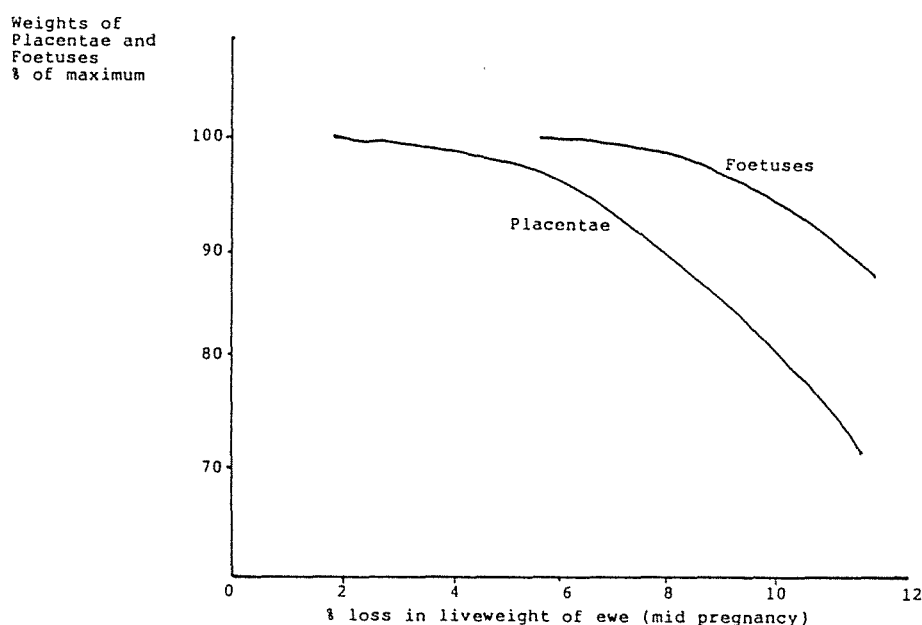

Ewes in good body condition can buffer the placental growth provided the under-nutrition is mild, (Davis 1984), whilst poor condition ewes in an under-nutrition situation during mid pregnancy resulted in a 20% birthweight reduction (Robinson, 1983). High fecundity flocks should be fed at maintenance during mid pregnancy to enable birthweights to be increased during late pregnancy. Russell (1985) recommended that multiple bearing ewes should be split on the basis of condition score to enable differential pregnancy feeding. Single bearing ewes can withstand a period of mild-nutrition (ie, up to 12 - 15% liveweight loss) without any adverse effects (Coop and Drew, 1963).

Davis (1984) noted that prolific ewes may require protein supplementation during pregnancy due to the increased protein requirements for foetal growth, mammary tissue and colostrum production, to avoid reductions in birthweights.

Geenty and Sykes (1983), and Ulyatt et al (1980) present and review the feeding levels necessary during the late pregnancy period.

6.2.4 Survival Summary

The major influence upon lamb survival is birthweight, with low birthweight lambs being at greatest risk from S-E syndrome deaths in which heat loss is greater than heat production. For multiple rearing ewes high mid pregnancy nutrition levels to increase placental size, enables birthweights to be manipulated during late pregnancy via nutrition. Larger, heavier ewes also produce higher birthweight lambs which "have more fat (energy reserves) to combat heat loss after birth and a more developed birthcoat for insulation once it is groomed by the ewe. A heavy lamb is a better competitor for milk in a little situation. Shelter and labour can compensate for low birthweight". (Rohloff, 1984).

6.3.0 LAMB GROWTH

High lamb growth rates are more efficient (Binnie, 1983) in that lambs growing at 200 gm/day and 50 gm/day require 7.8 and 18.4 kg Dry Matter (kgDM) per kg liveweight gain (LWG) respectively.

Lamb growth rate is dependent upon milk intake and the quantity and quality of pasture available to the lamb. During the first weeks of lactation lamb growth is solely dependent upon the quantity and quality of ewes' milk. (Barnicoat et al, 1949, 1957; Coop and Drew, 1963; Jagusch, 1977).

The quality of ewes' milk is variable (Jagusch, 1977; Treacher, 1983) due to breed, nutrition levels and litter sizes (Geenty 1974 - review - cited in Jagusch, 1977). First milk, ie colostrum, availability and intake reduces mortality rates and improves growth rates. With intakes of 0 and 60 gm/head colostrum resulting in growth rates of 174 and 325 gm/day respectively, (Spedding et al, 1970 - cited in Jagusch, 1977). Khalaf et al (1979) noted that under-nutrition during pregnancy resulted in lower colostrum production.

6.3.1 Milk Yield

Milk yield is highly correlated with lamb growth rates, ie 0.72 (Barnicoat et al, 1949), 0.75 (Scales, 1968), 0.9 (Wallace, 1949) with Geenty (1979) reporting that twin lamb growth rates are more strongly related to milk yield, (ie $r = 0.53$ to 0.7) than for single lambs, (ie $r = 0.17$ to 0.51). To achieve the maximum weight of LW/EM^2 requires high milk yields as the total volume of milk consumed influences the weaning weight of a lamb. (Glover, 1972; Wallace, 1948).

2 LW/EM, ie lambs weaned per ewe mated.

The number of lambs suckled increases the total milk yield with ewes rearing twin and triplet lambs producing 40% and 60% more than single rearing ewes, although the intake of each lamb in a multiple litter is lower than for singles.

Multiple rearing ewes reach peak lactation earlier and at a higher level than for single rearing ewes, but have a reduced persistency, resulting in no difference in milk production by week 12, of lactation. Single rearing ewes milk below their potential yield due to the inability of one lamb to fully utilise the milk produced, suggesting that in feed deficit situations single rearing ewes can be offered lower feed allowances to enable multiple rearing ewes to be fed at a higher level.

Milk yield increased with the age of ewe, with significant differences existing between breeds (Owens, 1957; Scales, 1967; Glover, 1972; Treacher, 1983) with naturally high fecundity breeds being superior to the wool breeds.

6.3.2 Nutritional Influences on Milk Yield

Ewe nutrition has the largest influence upon milk production levels (Jagusch, 1977). Late pregnancy under-nutrition has little influence upon milk yield providing that adequate lactation feeding levels occur. Peart (1967) reported that if ewes were in good body condition at lambing time, no carry-over effects on lamb growth occurred from pregnancy nutrition although Smeaton et al (1983) reported reduced ewe weaning weights.

McCance and Alexander (1959) demonstrated that late pregnancy nutrition does influence the degree and timing of lactation initiation with delays of up to 12 hours occurring following pregnancy under-nutrition.

Lactation nutrition has the greatest influence upon milk yield, with twin rearing ewes requiring 35% more energy than single rearing ewes. Voluntary feed intake restrictions limit intakes to levels below maintenance requirements resulting in multiple

rearing ewes losing body condition throughout the length of lactation. (Davis et al, 1983). Adequate body condition at lambing, (ie condition score 2.5 to 3.0) is essential to ensure multiple rearing ewes have the potential to buffer energy deficits. (Russell, 1985).

Geenty (1983) reviewed the influences of feeding levels upon the first six weeks of lactation, noting that peak milk production occurred at feed allowances of 6 - 8 kg DM per ewe per day.

Under-nutrition past the peak of lactation, (ie 2 - 3 weeks post lambing) results in proportionately less milk production from the total lactation. Under-nutrition which is limited to the first two weeks of lactation has no lasting effects on the rest of the lactation performance. (Geenty and Sykes, 1983). In high fecundity situations, under-nutrition should be restricted to the initial period of lactation only, with single rearing ewes restricted to a greater extent. (Black, 1985).

Rattray (1977) recommended that later lambing should be utilised to increase pasture cover at lambing avoiding early lactation feed restrictions. Thompson (1983) claimed that higher stocking rates and winter rotations were moving the feed deficit period into spring and recommended later lambing dates as later born lambs grew faster initially and by 12 weeks of age were similar weights to earlier born lambs. Parker (1984) reported that pasture cover at lambing could be increased via lambing later, the use of nitrogen and the adoption of longer winter rotations. Delaying the set stocking of ewes prior to lambing and the adoption of rotational grazing of ewes and lambs can minimise any early lactation feed deficit.

Hodgson (cited in Thompson, 1983) and McEwan et al (1983) reported maximum lamb growth rates on pastures maintained at 900 - 1000 kg DM/ha. Thompson (1983) recommended that once this level of pasture cover had been obtained, set stocking was preferable in order to maintain pasture quality.

Black (1985); Davis, Rohloff and Kelly (1985) recommend the splitting of multiple rearing ewes from single rearing ewes, so that triplets and twins have access to high pasture allowances and shelter. Using such a system, Black (1985) weaned 1.9 lambs/ewe at average weaning weights of 34 kg, 28 kg, 24 kg for singles, twins and triplets at 90 days of age.

Parker (1985) reporting a trial in which singles and multiples were split and offered different pasture allowances, found that twin ewe bodyweights were increased only during the first six weeks of lactation. The identification of multiples provided benefits in "... savings in labour, better utilisation of shelter and slope..."

6.3.3 Sex of Lamb

Fennessy (1985); Kirton (1981) reported that ram lambs grew approximately 5% faster than wether lambs, suggesting that ram lambs may provide one means of achieving the high fecundity management objective.

6.3.4 Lamb Growth Summary

Lamb growth prior to weaning is reliant upon the amount of milk produced by the ewe, which is largely determined by the nutritional status of the ewe during lactation and body condition at lambing. Multiple rearing ewes produce up to their potential milk yield provided high pasture allowances and body allowances and body condition scores are achieved early in lactation. High energy intakes are unobtainable due to voluntary feed intake restrictions necessitating high quality feed to minimise any deficit that is to be met from body reserves.

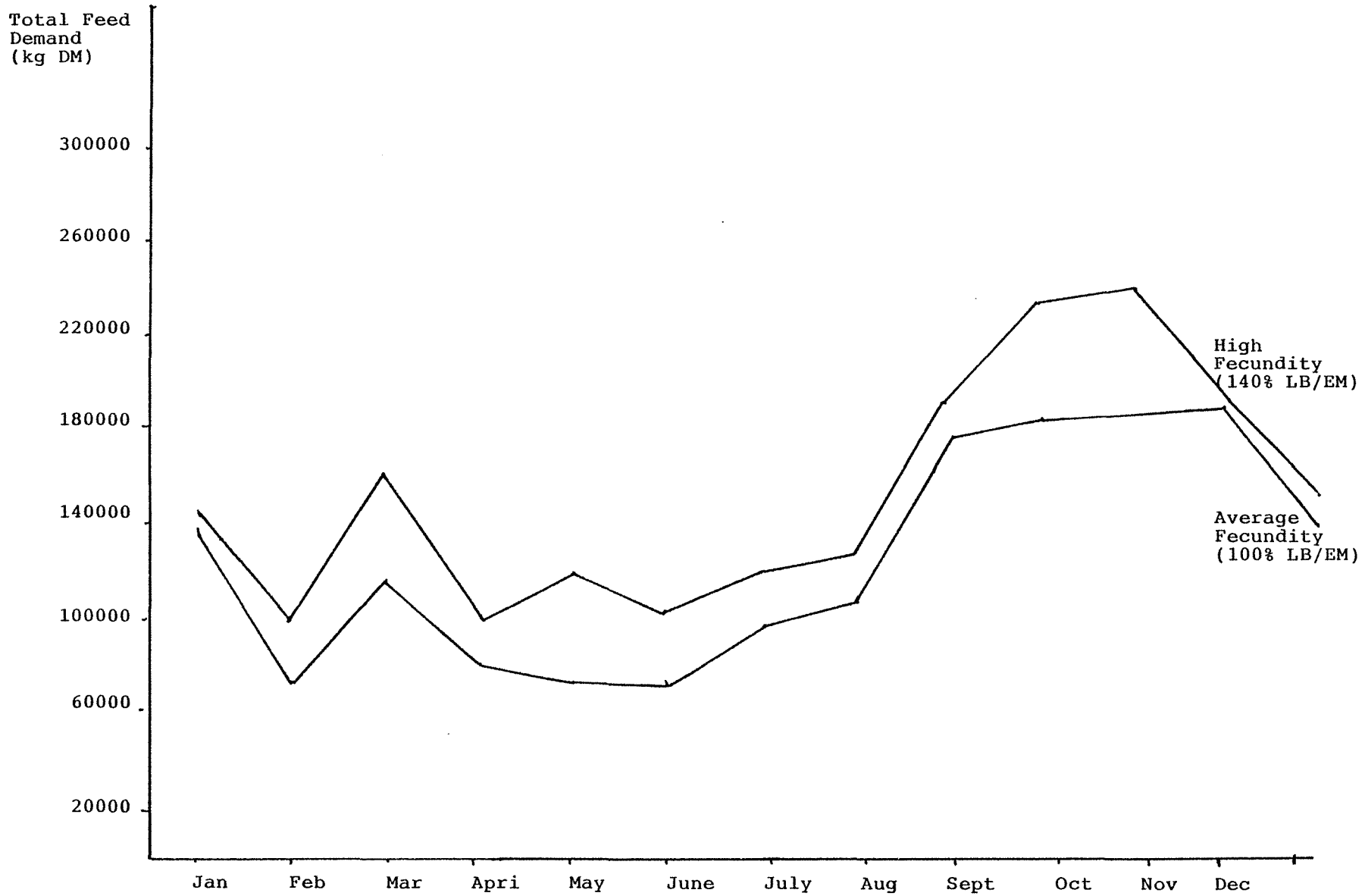

Figure 6:3 Feed Demand Profiles for 2000 Ewe Flock plus Replacements at Two Levels of Fecundity.

6.4.0 FEED DEMAND IMPLICATIONS

Figure 6.3 presents the predicted feed demand for a 2000 ewe flock plus replacements on a monthly basis, lambing at 100% and 140% LB/EM.

The average flock required 586 kg DM/ewe/annum which compares with 563 and 580 kg DM/ewe/annum reported by Scott et al (1976) and Rattray (1978). Replacement hoggets require 440 kg DM/head equating to 0.75 of ewe requirements.

The high fecundity flock requires 733 kg DM/ewe equating to 1.25 average fecundity ewes. The need for improved hogget rearing in high fecundity situations as noted by Davis and Kelly (1985) is highlighted with replacement hoggets requiring 538 kg DM per head, ie 0.92 of an average ewe. The high fecundity feed demands are similar to those reported by Rattray (1978), ie a 60 kg ewe producing 113% LW/EM required 710 kg DM/ewe/annum.

High Fecundity is not necessarily incompatible with high stocking rates, although fewer ewes may be carried this is compensated for by higher per head production. (Rohloff and Hinch, 1984).

Figure 6:3 indicates a higher feed demand in spring (25 - 30%) early winter (60%) and tugging (37%). The early winter increase is most likely to increase the likelihood of a spring deficit requiring either longer rotations, later lambing or the use of nitrogen (Parker, 1984).

Increased demand during the spring may assist in controlling pasture, minimising the build up in sward reproductive tissue, maximising pasture quality and growth (MAF undated).

Most New Zealand flocks are dual purpose with 50% or greater of total farm income being derived from wool production. Hawker (1984) reported the effects of high fecundity upon wool weights of 8500 Romney ewes. As the number of lambs increased, wool weights declined with twin and triplet rearing ewes producing 120 gms less wool per head, a reduction of 3% and 5% respectively.

Twin rearing ewes grew 8% more wool during summer and autumn, but 13% less during pregnancy and lactation. On a within flock basis, immunised ewes produced 1% less wool, whilst Booroola flocks produced 3% less wool. Hawker (1984) concluded that wool production is highly unlikely to reduce the 300 gm/ewe and by the 600 gm/ewe for twins and triplets respectively as claimed by Scobie and Jones (1983).

6.5.0 SUMMARY

High Fecundity management is defined as maximisation of the weight of lambs weaned per ewe from a flock with a lamb drop potential greater than 140% LB/EM. Successful management of high fecundity flocks is centred on the survival and growth of multiple lambs.

Multiple lambs are at greatest risk from starvation/ exposure syndrome deaths due to their lower birth weights. Lamb birth weights in the 3.5 to 5.0 kg range maximise survival rates. Late pregnancy nutrition can increase birth weights of multiple litters provided that mid pregnancy nutrition levels are adequate to maximise placental growth. Ewes in good body condition at tugging can lose up to five percent of liveweight during mid pregnancy without any adverse effects on placental development. However, poor condition ewes require maintenance feeding levels. Ewe body weight and mature size are also associated with lamb birth weights. Low birth weights may be compensated for by shelter or labour.

Lamb growth is affected by breed, sex of lamb and ewe milk yield - the largest single influence. Milk yield has a large between and within breed variation and is dependent upon the lactation nutrition of the ewe. Multiple rearing ewes milk to their potential, with early lactation nutritional stress having only a short term influence on the overall level of milk production, provided the stress is removed prior to the peak of lactation.

The high energy requirements needed to produce 2 - 3 kg milk per day in addition to maintenance is greater than the actual intake levels possible, resulting in multiple rearing ewes losing body condition during lactation. Body condition of multiple ewes at lambing should be above condition score 2.5 to 3.0 to enable the ewe to buffer milk production by mobilising body condition.

High fecund flocks require high body condition levels at tupping time with maintenance pregnancy feeding levels. Feeding allowances in early lactation require high pasture cover levels at lambing which can be achieved by long winter rotations or later lambing dates.

Feed demands are increased during winter period which may become a limitation, whereas the increased spring demands are likely to provide pasture control benefits.

CHAPTER SEVEN: DATA COLLECTION

7.0.0 INTRODUCTION

This chapter presents the procedures utilised to elicit reference concepts, measure the belief and attitude relationships and analyse the inter-relationships amongst these.

Twenty one properties were randomly selected from the study area described in chapter 6 and reference concept elicitation interviews performed. To obtain measures of the belief and attitude relationships, reference concepts representing the domain of high fecundity were identified and combined into a paired comparison format survey.

The resultant measures, provide the input for the Galileo methodology to provide the resulting co-ordinate set representing the spatial array of the (n+2) reference concept points within the (n+2) dimensional space.

7.1.0 REFERENCE CONCEPT ELICITATION

The initial task of any Galileo methodology study is to identify and define the act to be described by respondents. To minimise the risk of respondents interpreting the act differently, High Fecundity Sheep Management was defined as the successful management to maximise the weight of lamb weaned per ewe, from a flock with a lamb drop potential greater than 140% LB/EM.

7.1.1 Elicitation Interviews

Having defined the act, those reference concepts utilised by respondents to describe and define the act need to be identified. Woelfel et al (1977) recommend that reference concepts should be elicited by asking respondents to "talk about the topic (act) and

listen carefully to what they say." The objects, concepts etc that are mentioned most frequently are assumed to be the reference concepts by which respondents define and understand the act.

During this process Woelfel et al (1977) recommend that the interviewer should remain in a passive role, not suggesting or leading responses. As such the role of the interviewer is one of exploring and recording the reasoning behind the responses provided. This can be achieved by requesting respondents to expand on or rephrase specific components of their definition of the act.

Woelfel et al (1977) state that each interview should continue until no new words or thoughts are presented. An average interview is expected to last one half to three quarters of an hour. (Woelfel and Fink 1980).

7.1.2 Trial Interview

A trial interview was utilised to test the recommended techniques and to provide the author with an opportunity to develop the necessary skills. A co-operative farmer from outside of the study area was selected for the trial run. Two extension communication experts (one with experience of Galileo methodology) observed the interview with the co-operating farmer in order to comment on the effectiveness of the approach adopted by the author.

The trial interview was recorded on tape. In addition, written records were made by the author and the two observers. The need for accurate recording of the words used by the respondent was subsequently highlighted by discrepancies between the written records and the taped record. One problem encountered by the author was recording his own interpretation of the words used by the respondent instead of the actual words used. To overcome this the observers recommended that each interview should be taped in addition to the written record.

The trial interview highlighted the complexity of the act, with the interview lasting approximately three quarters of an hour, despite the respondent volunteering his opinions freely with only a minimum of probing necessary from the author.

During the trial interview a total of 286 concept words or short phrases were recorded, 147 of which were considered to be unique. Subsequent to the interview, the observers recommended that a 5 to 10 minute period at the beginning of each interview should be spent developing a rapport with the respondent, before proceeding with the interview proper, in order to develop an environment wherein the respondent was at ease and hence likely to provide a more complete response. A general discussion, not restricted to high fecundity production systems, should be developed at the end of each interview. In the trial interview this approach elicited several new concepts from the respondent.

7.1.3 Study Interviews

Woelfel et al (1977) recommend that interviews should be carried out over a most varied sample within the population being studied. The omission of any one group of opinions can result in incomplete representation of the domain of the act, distorting the overall definition obtained from the respondents in the subsequent measurement task. To achieve the widest possible variance in the sample interviewed, properties were randomly selected from each of the three average lambing percentage strata described in chapter 5. A total of 23 properties within the study area were approached for interviews, with the high and low groups each contributing seven properties each. Subsequently two farmers were unable to participate due to health and workload reasons, one from each of the high and low groups¹.

Woelfel et al (1977) recommend that the number of interviews should be determined by the size of the population, complexity of

¹ The proportion of each group interviewed was 0.27, 0.19, 0.18 for the High, Low and Average groups respectively. A more equal proportion of each group should have possibly been selected with fewer high group interviews.

the act and when no new concepts are being elicited. In this study slightly fewer interviews (18) would have identified the total number of concepts obtained.

Interviews ranged from approximately half an hour up to two hours, with the majority lasting on average just over one hour. Shorter duration interviews were associated with respondents who had difficulty in discussing the act which was abstract to them, ie the interview requires different tasks from different respondents in that a high group respondent discusses the system as he is achieving it, whilst the low group respondent is describing a system that he has only perceived, increasing the level of difficulty for the low group respondents.

For three respondents who had difficulty in discussing a 'perceived' system, a less structured version of the interactive discussion procedure proposed by Walker (1984) was utilised. This technique involved identifying the present management system, working through the farming year. Having discussed the present management system, the respondent was asked "Assuming you expected a lamb drop of 140%, how would you change your existing management, if at all?" In all three cases, respondents replied with a large number and diversity of concepts.

The procedures respondents underwent in the 'passive' interviews were similar, but less structured than the interactive interviews, in that responses were often stated in the context of the managers' existing situation which would require certain adjustments "due to" In researching complex acts such as management systems the use of a combination of passive techniques as recommended by Woelfel et al (1977) and the interactive procedure presented by Walker (1984) would appear to provide a more complete insight into respondents' perception of the act.

7.1.4 Interview Results

Two records of each interview (one written, one on tape) enabled the researcher to check that all words used by the respondent

were accurately recorded. Each tape was listened to twice after the original interview took place. The need for tape recording (especially the first 8 to 10 interviews) was apparent on listening to the tapes, with there being large discrepancies between the taped record and the words recorded by the researcher, especially during periods when large numbers of concepts were being discussed. This could be minimised by training, as by the last few interviews the written records were generally consistent with the taped records.

The lists of words and phrases from the interviews were aggregated into common categories on the basis of similarity of meaning. (Ferber (1984), refers to this step as "content analysis"). Each word from each interview was categorised on the basis of similarity of meaning within the two categories of input and outcome reference concepts. Woelfel et al (1977) claim that an average of 10 - 15 categories will account for between 75% and 95% of all words mentioned. Each category can then be labelled with a word or short phrase, preferably taken from the population sample responses.

From the 21 interviews undertaken, a master list of words (comprising 2852 words, an average of 136 words per interview) was compiled into a total of twelve categories accounting for 2510 words (88% of the original list).

7.1.5 Concept Weightings

Each of the three lambing performance groups defined in Chapter 5 weighted the concepts differently (as measured by the frequency of useage during the interview). Only the concepts with significant differences are discussed here.

a) Breed and Size of Breeding Ewes

The high group emphasised breed of sheep with a frequency of use approximately double that of the other two groups. The breed concept was utilised in two contexts by the high group. Firstly the need to have a breed capable of

achieving large mature sizes (bodyweight). Secondly, in the context that a flock needed to be of a consistent size (ie a small range in condition and liveweight) to regularly achieve high fecundity levels. The low and average groups never raised the second aspect in any interviews, a factor that may contribute to the large between year variance in performance for these groups relative to the high group.

Related concepts which had similar weightings were, ewe size (incl tupping weight); ewe feeding (no period of year specified); maintenance of ewe liveweight during pregnancy, and improved hogget rearing.

b) Lambing Concepts

The low group emphasised a later lambing date, with a frequency of use approximately double the high and average groups. The consensus across all groups was that a later lambing date would be advantageous in achieving potential production in high fecundity systems, provided lamb disposal options were not restricted.

The level of feed (pasture cover) at lambing was emphasised by the high and average groups very strongly, but only slightly by the low group (although the level of lambing feed was associated with the lambing date concept). Parker (1984) reported that pasture cover at lambing was positively associated with the level of lambing percentage.

All three groups felt that a set stocking regime in spring was preferable, claiming lamb and ewe growth rate advantages and behavioural benefits (stock more settled).

High feeding levels during ewe lactation were only reported by the high group as being strongly related to high fecundity management, consistent with the literature discussed in chapter 6.

Lamb survival was associated with successful high fecundity by all groups, with the high and medium groups placing a slightly greater emphasis than the low group. Overall, lamb survival concepts were not mentioned as frequently as shepherding concepts, with respondents frequently not clearly differentiating between the two.

The low group emphasised the need for easy care shepherding systems -in terms of reduced or equivalent labour to the existing situation. (This may reflect the increased farm size of the low group requiring a higher level of labour input). The high and average group emphasised the shepherding concept, to minimise mismothering problems, although in discussing this aspect further, the high and average group managers worked long hours during lambing, but on the whole handled very few stock, (with the exception of during bad weather).

The average and low groups placed stronger weightings on the identification of multiple rearing ewes before or at lambing, so that these could be fed preferentially to minimise the risk of sleepy sickness (pregnancy toxemia). Rohloff (1981) reported that high fecundity farmers identified multiple rearing ewes to maximise feed inputs for the higher order multiples, maximising lamb growth rates and minimising loss of ewe body condition. The high group farmers in this study only mentioned identification of multiples in relation to the cost being too high for the potential returns.

The low group emphasised the lamb price schedule and lamb fattening problems whereas the high group placed greater emphasis on the selection of disposal strategies which suited their feed supply and the body condition of breeding stock. The low group placed the heaviest weighting on summer pasture control, feeling that the inability to control pastures within their present situation was a major constraint to achieving high lamb growth rates, whereas the high group emphasised summer pasture control from the

viewpoint that a high fecund system enabled improved pasture control, thus reducing the problem of poorer pasture quality during summer.

Appendix 2:0 presents a diagrammatic representation of the high fecundity production system as developed from the interviews with respondents and the literature review of high fecundity sheep production presented in chapter 5.

7.1.6 Reference Concepts

From the interviews, twelve trial reference concepts (refer Table 7:1) were obtained and combined with two contrived concepts taken from the literature, ie 'higher birthweights of multiples' (refer chapter 5) and 'efficiency of farm' which was included as an evaluative concept. The reference concepts were trial concepts in that they were 'trialed' with respect to their interpretation, and respondent burden prior to being presented to the study area respondents. Cary (pers comm) recommended the inclusion of some evaluative concepts in an attempt to 'label' the attribute dimensions used to form the Galileo multidimensional space. Davis (1984) claimed that higher fecundity systems should be adopted because they are more efficient. Dickerson (1978), Hall (1979) and Large (1790) have demonstrated that total feed requirements for maintenance, are high (50% of the annual requirement) in typical sheep production systems. High fecundity levels have the potential to increase the biological efficiency of sheep production systems by decreasing the relative level of feed requirements for maintenance, hence the additional reference criteria.

Table 7:1 Trial Reference Concepts

Concept	Definition
1 Maintenance Pregnancy Feeding	Maintaining ewe body weight at or about its tugging weight fully accounting for foetal growth.
2 Reduced Stocking Rate	Running fewer but higher producing ewes, ie larger heavier mature weights resulting from improved hogget rearing.
3 Long Winter Rotations	A winter rotation of 80 - 90 days.
4 Growth Rate of Multiple Lambs	Achieving high (230 gm/day) growth rates.
5 Reduced Wool Weights	From the total flock.
6 High Fecundity	Achieving maximum weaning weight of lamb/ewe with a flock with a potential lamb drop of 140%.
7 Later Lambing; Higher Lactation Feeding	Increasing herbage mass at lambing time to maximise milk production.
8 Flexibility - lamb disposal	Increased options due to greater number of lambs for selection and lamb disposal.
9 Lower Labour - easy care	Reduced labour input especially at lambing time.
10 Set Stocking at Lambing	Set stocking immediately prior to or at lambing time to assist bonding.
11 Efficiency of Farm	Greater output per unit input.
12 Early - staggered weaning date	Weaning either all or a proportion of the flock earlier.
13 Summer Pasture Control	High pasture quality resulting from pasture control with cattle, tugging or ewe mob.
14 Self	Yourself.
15 Shelter	Effective shelter either artificial, trees or natural.
16 Higher Birthweights - multiple lambs	Self explanatory.

7.2.0 TRIAL PAIRED COMPARISON SURVEYS

A trial survey using the sixteen reference concepts (12 derived from the interviews, 2 from the literature plus the act and self) was carried out to test for any interpretation problems. The instructions (appendix 3:0) were designed according to those suggested by Woelfel et al (1977), Stewart (1979) and (Cary, pers comm), in which two reference concepts were selected and assigned a standard separation of 100 units. The criterion concepts of 'Long Winter Rotations' and 'Set Stocking in Spring' were selected, as both were system inputs and considered by the researcher to be dissimilar (ie dissimilar in physical terms, but as was subsequently discovered, similar on a time continuum and a managerial input (both grazing systems) context)). A standard separation of 100 units was chosen as being easy to comprehend and significant to measures made in the daily life of respondents, (ie metric measurement system, decimal currency system).

The trial paired comparison survey, comprising of 16 concepts, was given to 6 respondents (4 academics and 2 farmers) who were asked to complete the survey and then discuss the task and any specific difficulties encountered. Three respondents recorded the time to complete the pairings, with an average time taken of 26 minutes. In discussion with the respondents, it was felt that a 16 concept paired comparison was the maximum number of concepts that an individual could scale, recommending that if possible the task should be shortened.

Three respondents ascribed distances of less than 100 units to the criterion concept pairing because the two concepts were closely associated on a time continuum and on a management input classification, ie both concepts were seen as related aspects of the grazing system with spring set stocking following long winter rotations.

The concept 'reduced wool weight from the total flock' created interpretation difficulties. Respondents claimed it to be independent of most other concepts and in some instances,

independent of the act. Due to these difficulties this concept was replaced by 'Multiple Lamb Survival', reflecting the importance placed on lamb survival by both the literature and the respondent interviews where the shepherding concept often implied lamb survival.

The two concepts 'Practical' and 'Profitable' were utilised to replace the concept of 'efficiency of farm', which respondents interpreted in two separate ways, ie physical and biological efficiency (Practical) and financial efficiency (Profitable).

This resulted in 17 reference concepts to which the concept Identification of Multiples was added - (this concept was mentioned relatively frequently during the interviews and was considered to be important in the research literature), resulting in 18 concepts that were used in the final pair comparison survey. (Refer Table 7:2 for the definitions used).

Table 7:2 Study Reference Concepts

Concept	Definition
1 High Fecundity Management	See Table 6:1
2 Reduced Stocking Rate (I)	Running fewer but higher producing ewes, ie larger, heavier mature weights resulting from improved hogget rearing.
3 Multiple Lamb Survival (O)	Survival of Multiple lambs, especially over the first 3 - 5 days after birth.
4 Self	How favourably inclined toward or against the practices you are.
5 Maintaining Ewe Body Condition (I)	Maintaining body condition over pregnancy at its tupping weight, plus allowing for increased feed requirements during mid to late pregnancy for foetal growth (up to 15 - .17 kg liveweight gain for twin bearing ewes).
6 Higher Birth Weights of Multiple Lambs (O)	Birth weights that minimise the risk of starvation - exposure deaths.
7 Growth Rates of Multiple Lambs (O)	High growth rates to reach weaning weights of 20 kg live-weight plus at 10 weeks old.
8 Later Lambing/High Lactation Feeding (I)	See Table 6:1.
9 Controlled Set Stocking from Lambing to Weaning (I)	Set stocking immediately prior to or at lambing time to assist mothering and to control pasture cover to 2 - 3 inches (1000 kg DM/ha).
10 Summer Pasture Control (I)	High pasture quality by controlling summer growth (by stock or topping) to provide lamb fattening feed reserves.
11 Lower Labour, Easy Care Sheparding (I)	See Table 6:1.
12 Identification of Multiples (I)	Preferentially feeding multiple ewes in pregnancy and lactation to meet their higher feed requirements.

Table 7:2 Study Reference Concepts (cont.)

Concept	Definition
13 Profitable (0)	The likely contribution to overall farm productivity from the specific practice.
14 Flexibility of Lamb Disposal (0)	See Table 6:1.
15 Long Winter Rotations	Winter rotation of 80 - 90 days minimum.
16 Shelter (I)	See Table 6:1. Weaning all of the flock earlier or groups within the flock earlier, based on lamb sex, condition, ewe condition or feed supply.
18 Practical (0)	How feasible are the practices in a physical sense.

(I) - Input concepts

(0) - Outcome concept

Concept 1-10 - Common concepts

Cary (pers comm) reported the successful completion of paired comparison surveys using telephone interview techniques. However, this approach required approximately 80 minutes to complete by the one respondent who was asked to scale 14 concepts derived from the initial trial interview. The respondent commented that he had found the task extremely complex and difficult, feeling that his responses were unreliable. Postal surveys were therefore used to complete the paired comparison measurement task.

7.3.0 PAIRED COMPARISON SURVEY

Following the trial surveys a maximum of 14 concepts was set for each respondent to complete. A split design was considered to be one way of restricting the number of concepts per respondent to fourteen, but still utilise the 18 concepts (See Table 7:2). The split design was based upon 10 concepts being presented to the total population and the remaining 8 concepts being split into two groups of 4 concepts, each of which was presented to 50% of the sample. The 10 common concepts (See Table 7:2) were selected as being more central to the act (on the basis of frequency of mention during concept eliation interviews and from the research literature) and therefore were considered likely to be easier to measure.

7.3.1 Criterion Pair

Due to problems experienced by respondents in interpreting the criterion pair during the trial surveys, the alternative procedure of selecting the criterion pair concepts from outside the set of reference concepts was adopted (Cary, pers comm). The criterion concepts "All Sheep Farming" and "All Cash Cropping" were selected as being relevant to an 'agricultural audience'. The two criterion concepts were also distinct in their meaning, both being self explanatory with sufficient difference to justify the criterion distance to represent no similarity. The criterion

distance of 100 units was retained.

7.3.2 Administration

The instructions to respondents were altered (Appendix 4:0) from the trial surveys. An example of using a ratio judgement against a given separation on an open ended continuum (representing distance) was incorporated to introduce respondents to the task required of them.

The ordering of concepts used, was designed to reflect the order of concepts in the diagrammatic schema of high fecundity production systems. (Appendix 2:0). The presentation of reference concepts in a complex act, such as in a management version of soft systems, (where input and outcome concepts are separated in time), may necessitate stricter orderings of pairs of concepts in future studies to ensure commonality in scaling, ie to ensure that the scale used to separate pairs of reference concepts by a respondent remains constant over all comparison pairs. The order in which pairs of reference concepts are considered by a respondent may affect the maintenance of scale commonality.

The paired comparison survey was sent to 101 farmers within the study area from whom performance data had been collected. Respondents were coded within each of the three lambing performance strata and then randomly assigned to one of two groups, each of which received a different set of 14 concepts, (both groups received 10 common concepts).

The paired comparison survey was administered in a similar manner to the initial survey with a post paid return envelope included and a subsequent reminder notice forwarded. The introductory letter (see Appendix 4:0) reiterated the objectives of the research, emphasising the evaluation of methodology for analysing farmer perceptions in farm management research. Respondents were also advised that the paired comparisons required an

"instantaneous but thoughtful reply for each pair." They were asked, "not to spend a long time tossing over ideas for each pairing..." During the trial paired comparison surveys, some respondents said they had altered scaled values to be consistent with other values. In discussion with the respondents they expressed difficulty in accepting the adjusted value, as although the value was consistent (ie of the appropriate relativity) with other concept pairings, it was not always considered appropriate in representing the distance between the concepts being measured.

In addition to the study area farmers, a group of experts (29) consisting of researchers, advisory personnel and animal husbandry specialists working in the sheep production field were requested to complete the survey. The expert group was split similarly to the farmer group with each half receiving 14 reference concepts to scale. The expert group was expected to provide a close representation of the 'real' relationships underlying a high fecundity sheep production system.

7.3.3 Paired Comparison Results

A total of 89 replies (68%) were returned, of which 9 were either incomplete or only partially completed, leaving a total of 80 (62%) sets of data. The level of response is slightly lower than the 70% level considered ideal for postal surveys (Bourke, 1978) which could be explained by:

- 1) The complexity of the task required, which may have been perceived as being irrelevant or just too difficult by the respondent. Four of the incomplete surveys stated reasons similar to these.
- 2) The timing of the survey which was posted approximately one month prior to lambing and corresponded to a period of increased workload.
- 3) The attitude of the farming community towards increased sheep production, when the agricultural sector was undergoing significant change due to a move towards 'more market' policies.

The total of 80 completed sets of data comprised of 19 sets from the Expert group and 61 sets from the study area respondents representing return rates of 65.5% and 60.1% respectively. Including the nine incomplete returns a total return rate of 69% was achieved from the study area respondents.

7.3.4 Respondent Comments

Respondents were asked to comment about the research methodology. The most common comments are discussed below:

- 1) Standard Separation
Respondents claimed that the 100 units assigned to the standard separation made it very difficult to scale pairs consistently. Several respondents recommended that a standard separation of 10 or 20 units would make the task a lot easier.
- 2) Context of the Act
Some respondents found it difficult to ascertain whether they were scaling the concepts with respect to an ideal situation with no physical constraints or whether the act was to be scaled in the context of their existing property and its constraints.
- 3) Scaling of Self
Most comments contained references to scaling self, especially with respect to the evaluative concepts, ie Practical and Profitable. Several surveys were completed up to scaling self against the remaining concepts in one block. (See Appendix 4:0).
- 4) Other comments indicated that respondents often found the initial pairing were very difficult, but felt more at ease with the task after the first few pairings were completed. To overcome or minimise this problem the first few concept pairings could involve concepts that are not part of the study proper.

7.4.0 DATA FORMATTING AND ANALYSIS

All data was formatted according to the instructions recommended by Woelfel and Fink (1980), with each data set being ascribed a 3 digit identification code, leaving 5 columns available for demographic variables. Although all 5 columns were utilised (demographic variables were farm size; stocking rate; highest lambing percentage experienced; manager's age; information sources), only the variable highest lambing percentage was used during the analysis stage of this study.

Highest lambing experienced was defined as respondents who achieved a highest lambing percentage of either 116% LW/EJ and above (Hilamb experienced) or below 116% LW/EJ (Hilamb no experience). This categorisation was used due to insufficient respondent numbers to achieve more than a two way split and also because it is consistent with the cognitive experiential learning theories presented in Chapter 2 as the psychological basis of soft learning systems.

7.5.0 RESPONDENT CHARACTERISTICS

Of the 61 respondents who returned the surveys 13, 17 and 31 were from the High, Low and Medium average lambing percentage groups respectively. (See Figure 7:1). The range of average lambing percentage for the paired comparison survey was 82% to 140% compared with 81% to 140% for the initial survey.

Table 7:3 presents the results for the paired comparison respondents, categorised on the basis of the Highest Lambing experienced.

Table 7:3 Hilamb Experienced versus Inexperienced Demographics

Variable	Experienced (n=24)	Inexperienced (n=37)	Total (n=61)
Area (hectares)	212.7	342	291.2
Flat (%)	44	15	26.0
Rolling (%)	37	47	43
Steep (%)	19	38	31
Stock Units	2769	3663	3311
Stocking Rate (su/ha)	13.0	10.7	11.6
Age (years)	43	43.5	43.3
Manage (years)	18.5	17.8	18.08
Paddock Numbers	39.7	45	42.9
Ave Paddock Size (ha)	5.36	7.6	5.61
Preferred No. Paddocks	55.4	55.9	55.7
Preferred Average Paddock Size (ha)	3.83	6.12	5.22

The Experienced group comprised 24 respondents with an average farm size of 213 ha, of which 44% and 19% were classified as flat and steep respectively. The Inexperienced group comprised 37 respondents with an average farm size of 342 ha of which 15% and 38% were classified as flat and steep. These results are consistent with those presented in chapter 5 although the average farm size of 291 ha is slightly higher than for the total initial samples. The Experience group carried 2769 stock units at a stocking rate of 13 su/ha compared with the 3663 stock units at a stocking rate of 10.7 su/ha. Overall, 61 respondents, an average of 3311 su were carried at a stocking rate of 11.4 su/ha.

Although only 60% of surveys were useable, the results presented above are consistent with the results achieved from the initial survey.

The categorisation based on highest lambing resulted in nine respondents from the average lambing percentage group being placed into the experienced group.

In addition, information was also collected on subdivision. The average property was subdivided into 43 paddocks with an average of 56 paddocks with an average size of 5.2 ha. The Experienced group had fewer paddocks (39.7 cf 45) and a smaller average paddock size (5.36 ha cf 7.6 ha) than the Inexperienced group. Both groups had similar ideal numbers of paddocks, with the Experienced group having a smaller preferred average paddock size (3.82 ha cf 6.12 ha).

Figure 7:1 Comparison of Initial Survey Respondents and the paired Comparison Respondents, based upon their Average Lambing Percentage.

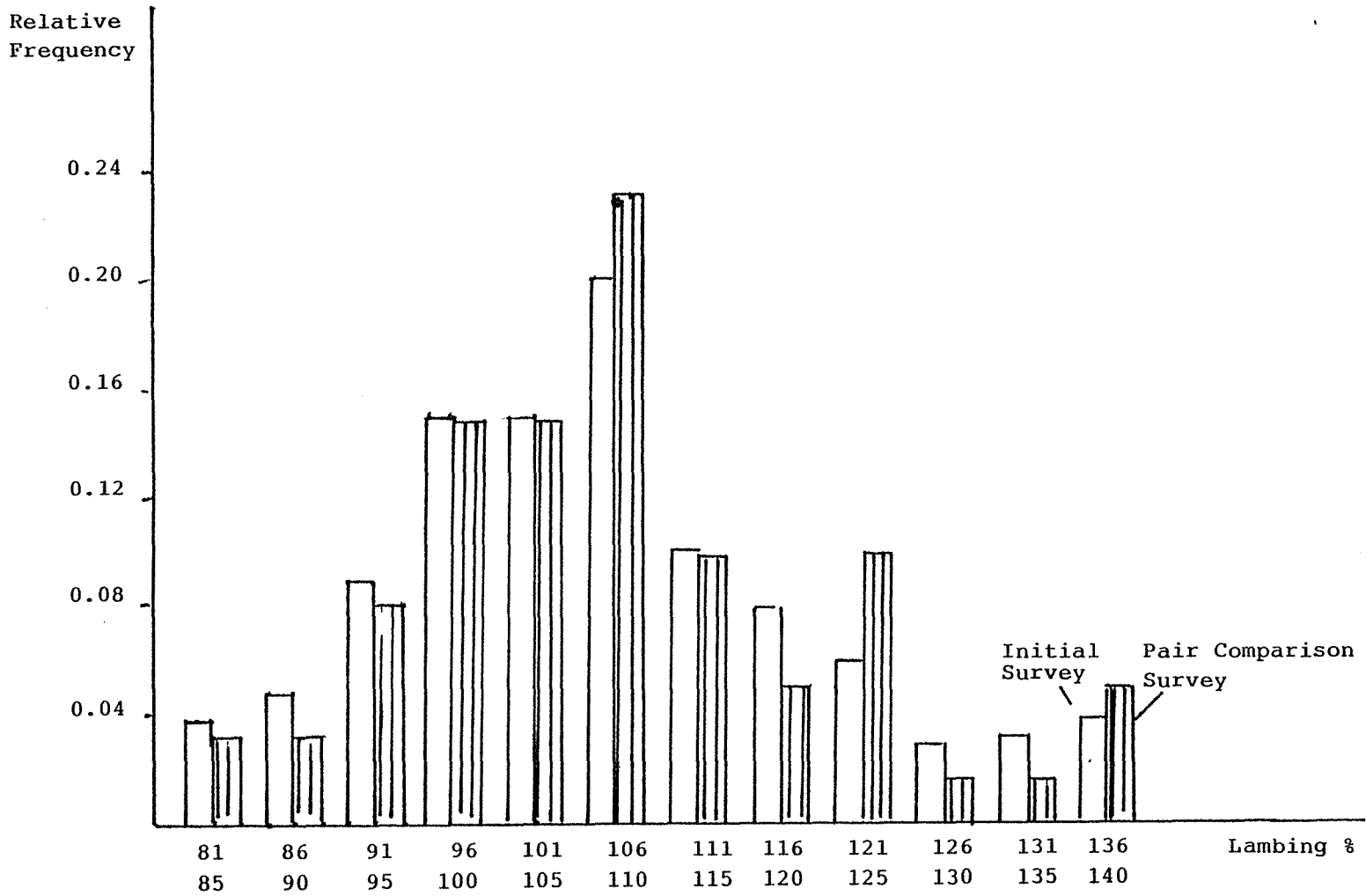

The average age of respondents was 43 years (ranging from 23 to 73 years) with an average of 18 years as a manager or owner. The Experience group had managed or owned a property for slightly longer than the Inexperienced group.

Table 7:4 presents the relative proportions of farmer education levels.

Table 7:4 Educational Qualifications

	Nil	5th Form	6th Form	7th Form	Univer- sity	Trade Cert
Number of Farmers	13	19	8	6	13	1
Relative Proport. %	21.6	31.6	13.3	10	21.6	1.6
(One respondent did not complete this section)						

Table 7:5 presents the results with respect to the use of information sources and advice. Eighty three percent of farmers use advice sources, with 59% of farmers having contact with MAF advisors and 69.43% using veterinarians, the most used sources of advice. Approximately 45% of respondents utilised technical literature (such as Aglinks) with 91.6% receiving popular press literature (NZ Farmer, NZ Journal of Agriculture); 88% of respondents used groups (discussion groups) whilst 64% attend short courses (incl seminars).

Table 7:5 Information and Advice Sources

A. Advice	Number	Percentage
MAF Advisor	7	11.8
Pvte Consultant	1	1.7
Veterinarian	9	15.3
MAF plus Veterinarian	23	39
Consultant plus Veterinarian	4	6.7
MAF, Consultant, Veterinarian	5	8.5
Nil	10	17
B. Literature		
Popular Press	30	50
Technical	2	3.3
Both	25	41.6
Nil	3	5
C. Groups, Field Days		
Discussion Groups (Field Days)	37	62.7
Short Courses (Seminars)	19	32.2
Nil	7	11.8

Respondents use most available information sources, although 10 - 20% receive limited or no information and advice. The possibility of intervening with most farmers through existing channels would appear to exist. However, contact with the remaining 10 - 20% would need to be initiated.

7.6.0 GALILEO ANALYSIS

The Galileo analysis was executed at the University of Melbourne (Australia) on a Vax computer, with the Galileo, RPI version (1979) software. Initially analyses for the expert; all farmers; Experienced farmers and the Inexperienced farmers using all 18 concepts was carried out.

The split design used, provided no measures for the distances between the two groups of four concepts that were presented to each half of the sample respondents. For the Galileo analysis, these values were treated as missing values, resulting in the total mean separation across all concepts being substituted into the means matrix as the estimated separation between these concepts, reducing the accuracy of the resulting co-ordinate system. (This problem could have been avoided by using a fractional factorial design, however the sample size prohibited this).

Due to the inaccuracy involved, the 10 concepts common to all respondents were collated and run as a separate 'dataset'. The results presented in this report refer only to the 10 common concepts.

Although the standard separation of 100 units was provided, elicited separations ranged up to 10 000 units. Given a large sample size (1000 or greater) such values may not have a very large influence, as each matrix cell is the average of all respondents. However, with a small sample size as in this study, very large numbers relative to the average response may artificially increase the mean separation between two concepts for one group. Accordingly, an arbitrary maximum separation value of 1000 units was set in this study, and substituted for survey values exceeding 1000 units.

For the farmer dataset, 26 values exceeded the maximum value (reported by 4 respondents) representing less than one percent of all the separation values. The expert dataset contained 19 values greater than 1000 (reported by 2 respondents, 1 providing 17 such values).

For each of the 4 analyses of the set of 10 common reference concepts, a set of co-ordinates (see Chapter four) were derived. These were then utilised to spatially represent the belief and attitude measures and to compare these measures across groups. Procrustes rotations are used within the Galileo methodology for this comparison, with the 2 concepts self and the act selected as being the invariant concepts across the datasets, ie the differences in the datasets are attributed to the 8 input and outcome concepts.

7.7.0 SUMMARY

This chapter presented the procedures used to operationalise the Galileo methodology for measuring the cognitive structures associated with the act of managing a high fecundity sheep production system. Reference concepts were elicited from twenty one randomly selected respondents using the passive interview techniques recommended by Woelfel et al (1977). Due to the difficulties expressed by some respondents, the interactive discussion technique proposed by Walker (1985) was used in association with the passive interview techniques.

The derivation of the reference concept set from the words elicited from the respondents was discussed. Words were aggregated on a within input and within outcome basis, to avoid confusing or illogical concepts. The initial reference concept was trialed and adjusted to minimise interpretation problems.

A split design of the paired comparisons was used to measure the inter-relationships between the 18 reference concepts. The ordering of the reference concepts and their presentation to 101 study area farmers and a group of 29 experts was discussed. A total of 89 replies (68%) resulting in 80 complete sets of data were obtained, consisting of 61 sets from farmer respondents and 19 sets from the expert group. Due to the limited number of respondents and the acceptance of the cognitive experiential learning theories as the basis of soft systems, the demographic

variable highest lambing percentage experienced was used to provide two groups within the population. The datasets were analysed at the University of Melbourne using the Galileo (RPI version, 1979) software package (Woelfel et al, 1979).

Chapter 8 presents the results of the paired comparison survey and the analysis of this data using the multivariate analysis techniques presented in chapter 4.

CHAPTER EIGHT: RESULTS

8.0.0 INTRODUCTION

As discussed in chapter 7 Galileo analysis of ten common concepts was carried out separately for the Expert and Total Farmer samples, and for the Hilamb experience and Hilamb no experience groups within the total Farmer sample.

This chapter presents and discusses the results of the Galileo analysis.

8.1.0 BELIEF AND ATTITUDE MEASURES

Galileo methodology measures belief and attitude relationships as a distance relative to the standard separation of 100 units between the two criterion concepts.

The mean separation reported by the Expert and Farmer groups was 44.2 units and 42.4 units respectively, indicating that both groups have used similar scales of measure (Cary, pers comm).

The separating of the two performances strata (ie Hilamb experience (Exp)) group comprising of those farmers that had experienced a lambing percentage of greater than 116% LW/EJ and an Hilamb no experience group (Inexp.) group for those farmers not experiencing a lambing percentage of 116% LW/EJ) resulted in mean separations of 51.5 and 36.5 units respectively indicating that differences existed between the two performance strata. As a result of this difference the total farmer group is not discussed in detail.

8.2.0 OVERALL ATTITUDES

The overall attitude is the predictor of behaviour, as a function of the belief and evaluative attitude relationships.

The overall attitude relationships were expected to display increasing favourableness with increasing levels of experience of high fecundity.

Such a trend was reported by the respondents with the Expert group (11.3 \pm 10.3(SD)) displaying a stronger attitude than the Farmer group (36.3 \pm 36 (SD)). The farmer group group also reported an increasingly favourable overall attitude with increasing experience levels, (Exp 21.8 \pm 38.8(SD) and Inexp. 41.8 \pm 33.7(SD)).

The relative overall attitude measures obtained support the cross sectional design of this study, with the Expert group being representative of the real world representation.

8.3.0 PRINCIPAL BELIEF MEASURES

The mean principal belief measures, ie the separation between the act and the set of reference concepts, for each group are presented in Table 8:1. A discussion of these results is presented for each group after section 8:4:0 Evaluative Attitude measures.

Table 8:1 Mean Principal Belief Measures for the Expert, Farmer Experienced and Inexperienced groups. (+SD)

Reference Concept	Expert	Farmer	Experienced	Inexperienced
Reduced Stocking Rate	66.0 (43.9)	34.0 (29.9)	44.8 (34.7)	27.4 (24.6)
Multiple Lamb Survival	23.4 (34.0)	46.0 (109.0)	76.6 (167.8)	26.0 (28.7)
Ewe Body Condition	26.3 (22.5)	26.1 (20.8)	33.3 (21.5)	21.4 (19.3)
Multiple Lamb Birthweight	27.6 (32.4)	37.1 (40.3)	46.6 (49.3)	31.0 (32.5)
Multiple Lamb Growth Rate	18.4 (24.0)	41.3 (51.6)	52.9 (74.3)	33.9 (27.5)
Later Lambing Dates	12.6 (13.6)	23.0 (26.3)	24.0 (34.3)	22.4 (20.0)
Controlled Set Stocking	16.8 (12.0)	33.0 (37.8)	31.7 (36.3)	33.9 (39.2)
Summer Pasture Control	43.4 (58.4)	49.0 (129.0)	42.1 (49.9)	63.0 (161.1)

8.4.0 EVALUATIVE ATTITUDE MEASURES

The mean evaluative attitude measures, ie the separation between the reference concepts and self, for each groups are presented in Table 8.2.

Table 8:2 Evaluative Attitude for the Expert, Farmer, Experienced and Inexperienced groups (Standard Deviation)

Reference	Expert	Farmer	Experienced	Inexperienced
Reduced Stocking Rate	76.0 (78.5)	38.6 (44.5)	38.5 (42.8)	38.6 (46.1)
Multiple Lamb Survival	12.4 (9.5)	26.2 (34.4)	14.0 (22.9)	33.4 (38.8)
Ewe Body Condition	29.5 (22.7)	41.5 (129.0)	67.9 (200.3)	24.4 (26.2)
Multiple Lamb Birthweight	16.3 (19.3)	43.6 (128.0)	2.7 (200.4)	24.6 (26.2)
Multiple Lamb Growth Rate	22.6 (46.2)	34.0 (66.4)	55.5 (100.3)	20.0 (19.9)
Later Lambing Dates	12.1 (17.5)	21.8 (23.4)	24.8 (24.3)	19.9 (22.9)
Controlled Set Stocking	23.2 (22.3)	31.2 (95.7)	22.3 (23.6)	37.0 (121.8)
Summer Pasture Control	28.2 (53.7)	54.9 (160.3)	62.9 (160.3)	49.7 (162.3)

8.5.0 DISCUSSION OF PRINCIPAL BELIEF: EVALUATIVE ATTITUDE MEASURES

8.5.1 Expert Group

The mean principal belief and evaluative attitude measures for each references concept are presented in Figure 8.1.

The Expert group displayed Principal beliefs and Evaluative attitudes that were closely aligned. The exception to this being the concept of improved summer pasture control (concept 10). Experts were relatively indifferent with respect to this management input to achieve a high fecundity production system. The Experts on average relate summer pasture control quite strongly with themselves.

The concept of reduced stocking rate (concept 2) was not considered to be an important management input and the Experts in themselves did not relate to the concept of reduced stocking rates.

Very strongly associated with high fecundity was later lambing (concept 8) as a management input, with a close association attached to controlled set stocking and multiple lamb growth rates (concepts 7; 9).

The Experts did not associate multiple lamb birthweight, multiple lamb growth and ewe body conditions (concepts 3, 5, 6) close to the act, but were associating the concepts of multiple lamb birthweights and growth rates very strongly to themselves ie the Experts on average associate with the concept of birthweight and growth rate very strongly but are not as sure about their necessity as a management input for high fecundity production systems.

Figure 8:1 Evaluative Attitude - Principal Belief Measure for the Expert Group.

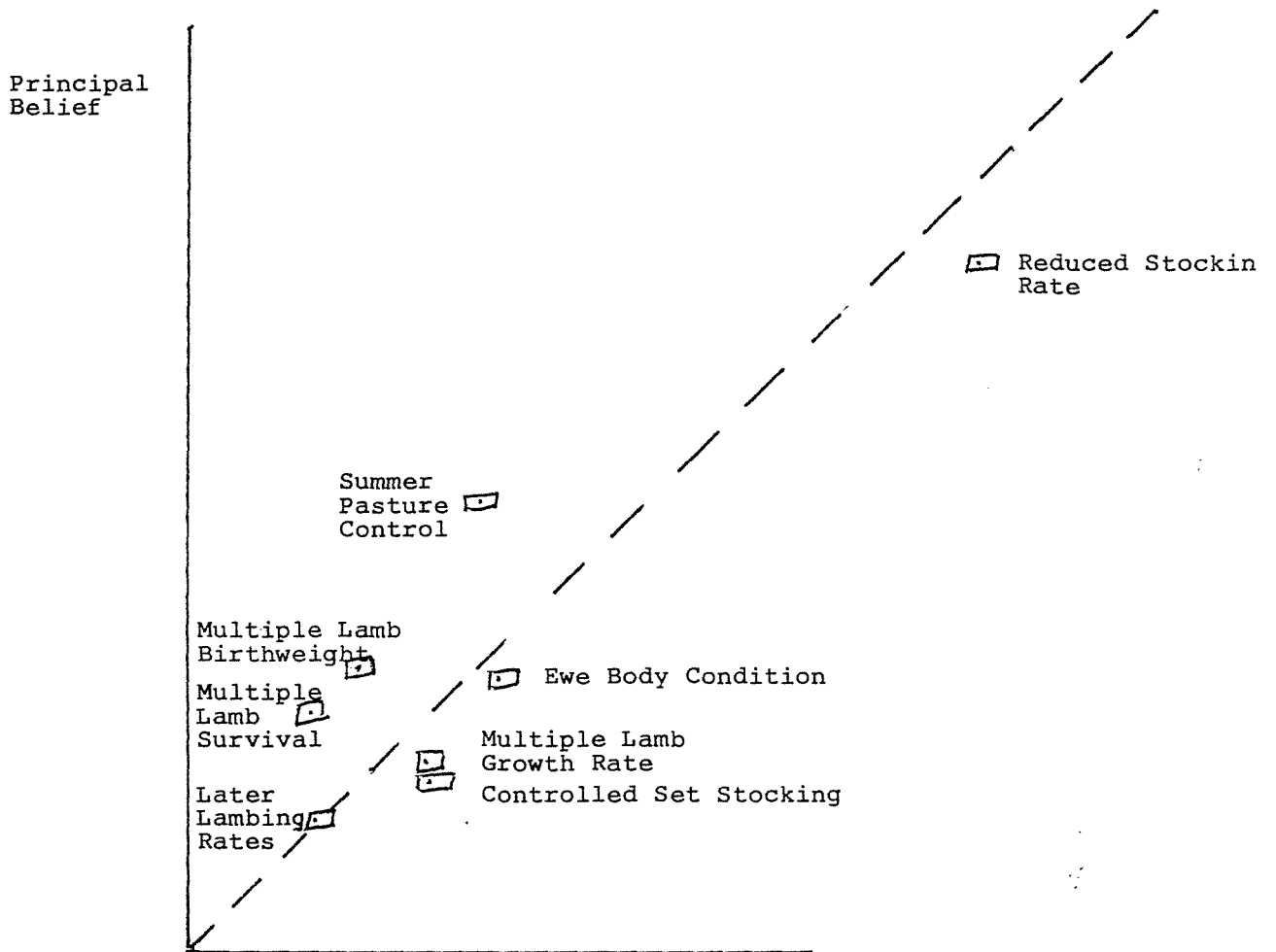

8.5.2 Hilamb Experience Group of Farmers

The mean principal belief - evaluative attitude measures for each reference concept are presented in Figure 8.2.

Figure 8:2 Principal belief - Evaluative attitude measures for the Experienced Group

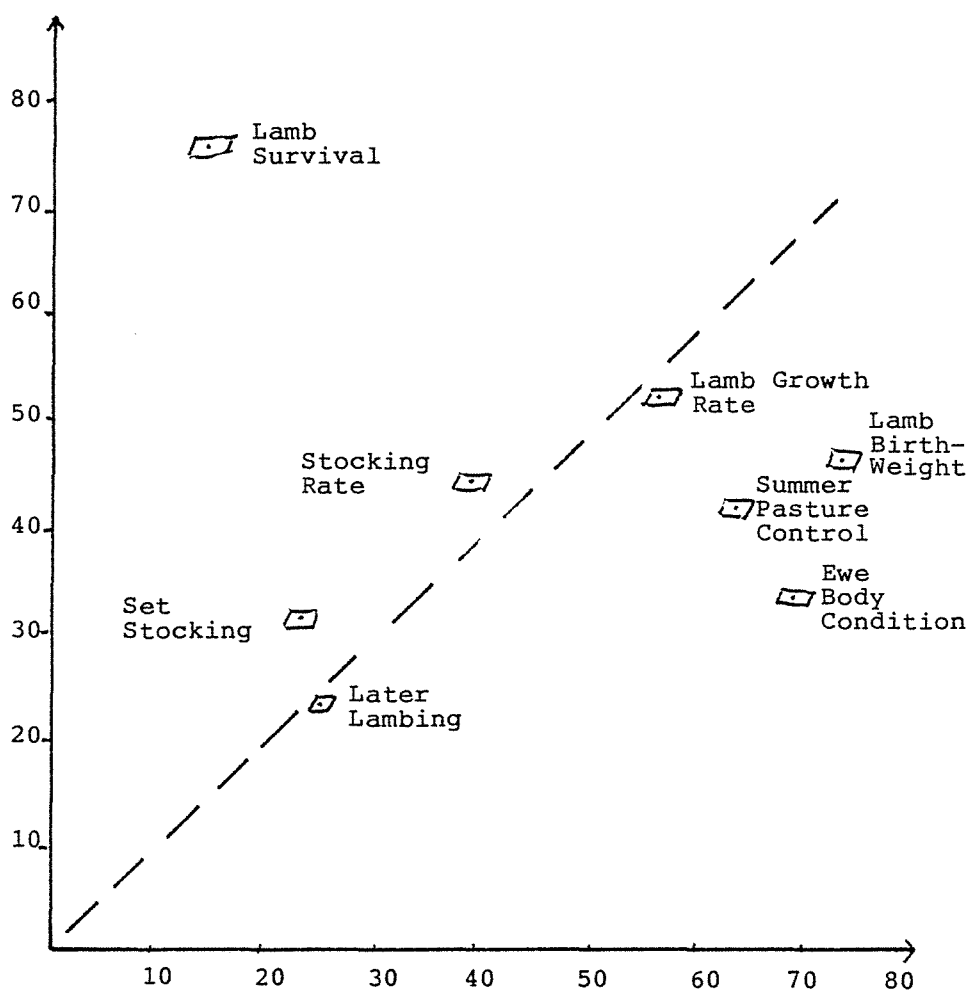

Of the three groups the Experienced group displayed the least degree of alignment, only the concepts of later lambing, controlled set stocking, reduced stocking rates and multiple lamb growth rates (concepts 2, 7, 8, 9) being closely aligned. The concept of multiple lamb survival (concept 3) is totally out of align with very little association to high fecundity production systems being recorded by the Experienced group whom closely associate themselves with multiple lamb survival, such that they are likely to institute management strategies to enhance multiple lamb survival.

In the minds of the Experienced group the concepts of later lambing, controlled set stocking and maintaining ewe body condition are most closely associated with a high fecundity production system.

The concepts of multiple lamb birthweight, summer pasture control and body condition have an association with high fecundity production systems ranging from slight to moderate respectively, the attitude towards these concepts is significantly less positive indicating that these concepts are likely to have a lower overall adoption with respect to the act.

8.5.3 HiLamb Inexperience Group of Farmers

The mean act-concept; self-concept distances are presented in Figure 8:3 for the Inexperienced group.

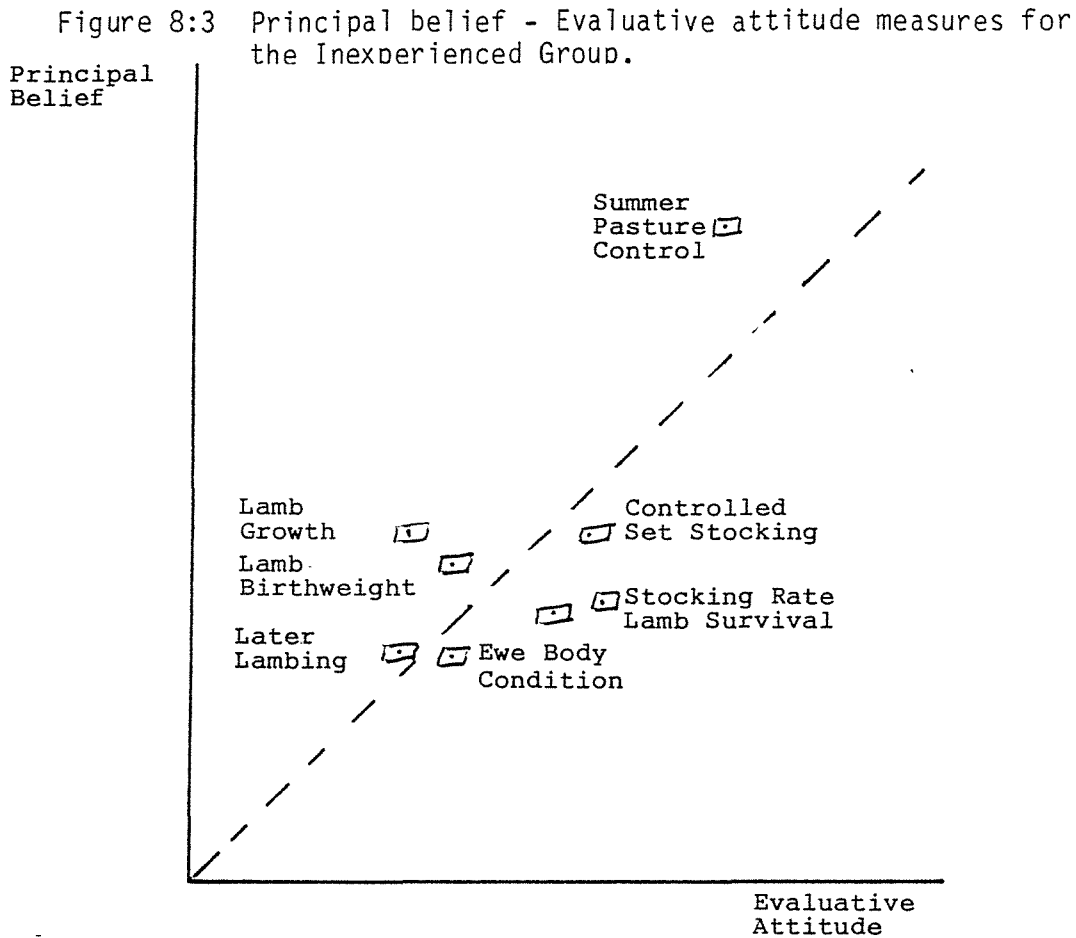

All reference concepts display a close alignment between their associated principal belief and evaluative attitude measures.

On average, all concepts were considered to be moderately strongly associated with the act and self, with the exception of summer pasture control (Concept 10) which is not associated with the act.

There appeared to be very little differentiation between the concepts with respect to the act and only slightly more with respect to the associated attitudes compared with both other groups.

8.5.4 Intergroup Comparisons

Figure 8:4 through to 8:11 present each reference concepts principal belief and evaluative attitude for each of the Expert; Hilamb experience and Hilamb no experience groups.

Figures 8:4 to 8:11 Intergroup Comparisons for each group Principal belief and Evaluative Attitude for each reference concept.

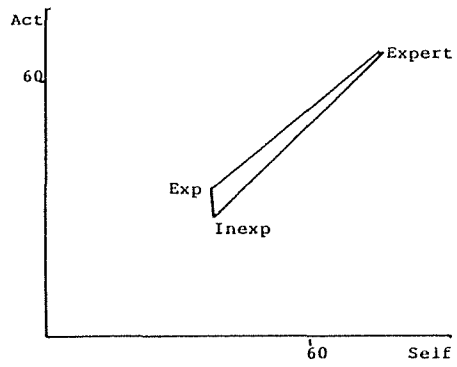

Fig 8.4 Reduced Stocking Rate

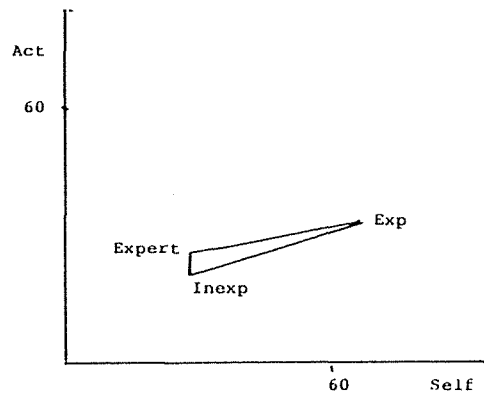

Fig 8.5 Ewe Body Condition

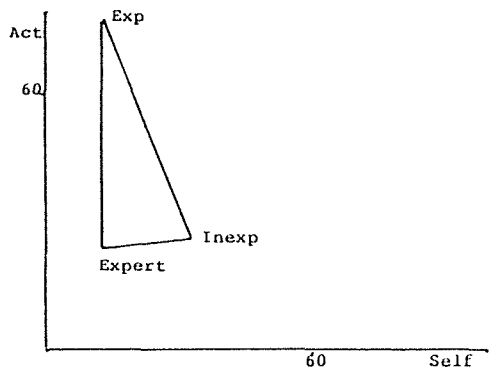

Fig 8.6 Multiple Lamb Survival

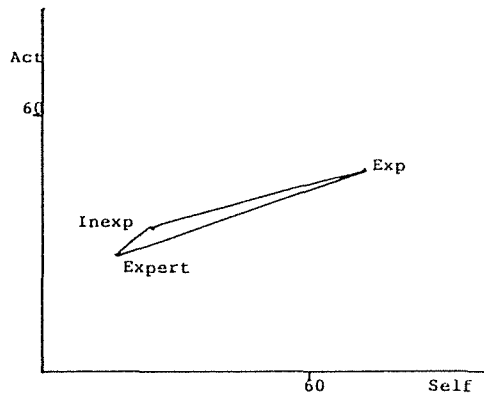

Fig 8.7 Multiple Lamb Birthweight

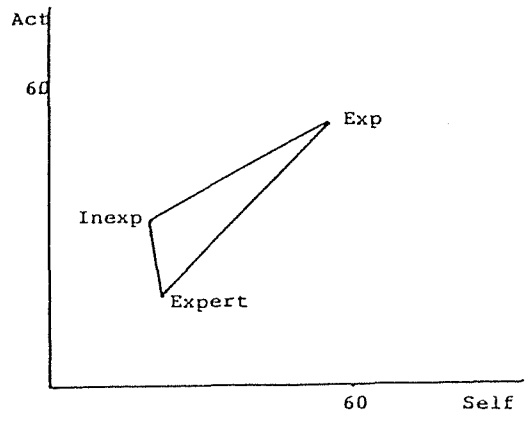

Fig 8.8 Multiple Lamb Growth Rates

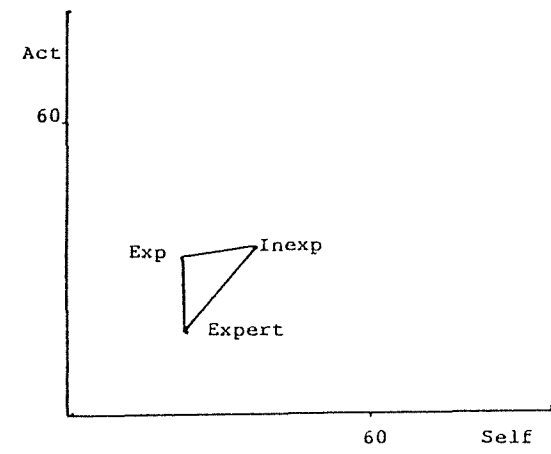

Fig 8.9 Controlled Set Stocking

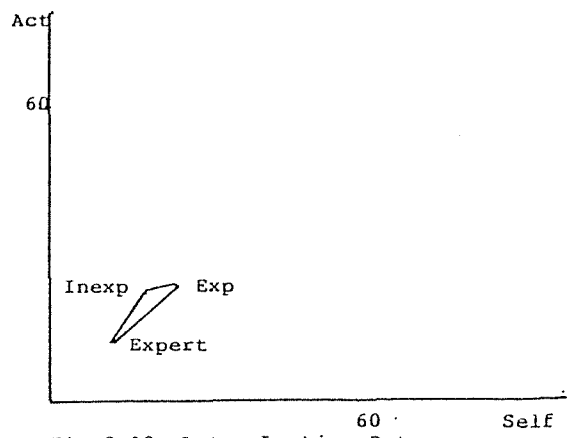

Fig 8.10 Later Lambing Dates

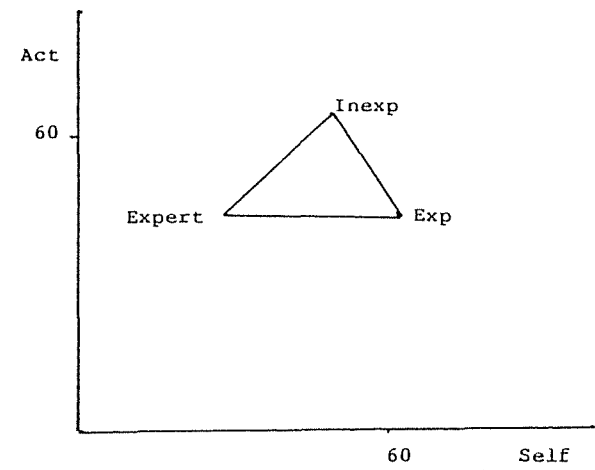

Fig 8.11 Summer Pasture Control

The two farmer groups had similar associations for the concepts of reduced stocking rates and later lambing dates. The remaining concepts indicate that on average the Expert and Inexperienced farmers tend to have more similar associations, whilst the Experienced farmers reporting differing beliefs (ie multiple survival), and attitudes (ie ewe body condition, multiple lamb birthweight), or both (multiple lamb growth rates).

For the concept controlled set stocking similar beliefs were held by both farmer groups, but with differing attitudes, whilst the Expert group reported a similar attitude to the Experienced group but a different belief.

Experts and Experienced farmers hold similar beliefs with respect to summer pasture control but differ significantly in their attitude towards this.

The most consistently (and strongly) associated concept ie later lambing concept, was considered to be an important management input by all groups, who also reported very positive attitudes towards it.

8.6.0 PERIPHERAL BELIEFS

8.6.1 Reduced Stocking Rate

The peripheral beliefs associated with the reduced stocking rate concept are presented in Table 8:3.

Table 8:3 Reduced Stocking Rate peripheral beliefs for the Expert, Farmer, Experience and Inexperienced groups. (Standard Deviation)

Reference Concept	Expert	Farmer	Experienced	Inexperienced
Multiple Lamb Survival	67.8 (67.6)	58.2 (142.0)	90.2 (218.5)	37.3 (45.3)
Ewe Body Condition	50.0 (69.1)	29.2 (42.2)	28.6 (41.3)	29.6 (43.8)
Multiple Lamb Birthweight	39.7 (33.1)	38.9 (71.8)	50.4 (100.2)	31.4 (45.1)
Multiple Lamb Growth Rate	47.4 (51.8)	38.4 (92.1)	58.0 (137.6)	26.0 (42.6)
Later Lambing Dates	82.0 (90.1)	51.5 (80.9)	55.0 (100.4)	49.2 (66.4)
Controlled Set Stocking	70.5 (64.7)	53.3 (75.6)	56.3 (73.2)	51.4 (78.0)
Summer Pasture Control	125.0 (183.0)	107.9 (192.0)	87.7 (204.3)	120.8 (185.5)

(a) Multiple Lamb Survival

Multiple lamb survival was associated most closely to reduced stocking rates by the Inexperienced group (37.3±45.3). The Expert and Experienced groups reported weaker associations respectively, although the Experienced group displayed a large degree of variation.

(b) Maintaining Ewe Body Condition during Pregnancy

The Farmer groups consistently associated the ewe body condition concept with reduced stocking rates regardless of the level of experience. Experts reported an average association but with a large degree of variance.

(c) Multiple Lamb Birthweight

The Expert and Farmer groups (39.7_±33.1; 38.9_±71.8 respectively) held moderately strong peripheral beliefs involving reduced stocking rates and multiple lamb birthweights. Within the Farmer group experience tended to result in a weaker belief (50.44_±100.2 vs 31.4_±45.1 for the Experienced and Inexperienced groups respectively). This trend is consistent with the peripheral belief involving reduced stocking rates and maintaining ewe body condition.

(d) Multiple Lamb Growth Rates

Increasing levels of experience resulted in a weaker association between reduced stocking rates and multiple lamb growth rates supporting the findings of Rohloff (1983); Owens (1984). The stronger association reported by the Inexperienced group (26_± 42.6) may reflect the greater tendency of this group to be located in the low summer rainfall areas.

(e) Later Lambing - High Lactation Feeding

The Farmer group (51.5_± 80.9) held a stronger belief than the Expert group (82_± 90.1) who reported a weak association. The weaker belief strengths are consistent with the findings of Rattray (1972) and Thompson (1983) that higher stocking rates require a later lambing date due to spring feed demand levels. The large variance in each group could be explained by comments from the Expert group that the concept should have been split into two separate concepts, viz:

- 1) Later Lambing Dates
- 2) High Lactation Feeding Levels

(f) Controlled Spring Set Stocking

All groups held average to weak beliefs that reduced stocking rates and controlled spring set stocking were related, with there being no significant differences between the Experience groups and the Farmer group.

(g) Summer Pasture Control

All groups reported virtually no association between reduced stocking rates and summer pasture control, although the mean distances had large variances which may reflect the open ended nature of the measurement system in that some respondents viewed 100 units as no association whilst others used numbers up to 3500 units - this warrants further research.

8.6.2 Multiple Lamb Survival

The peripheral belief measures involving the multiple lamb survival concept are presented in Table 8:4.

Table 8:4 Peripheral Belief Measures involving Multiple Lamb Survival (Standard Deviation)

Reference	Expert	Farmer	Experienced	Inexperienced
Ewe Body Condition	23.7 (24.4)	21.5 (23.7)	20.6 (21.4)	22.1 (25.4)
Multiple Lamb Birthweight	11.6 (10.3)	47.4 (161.0)	84.8 (252.8)	21.8 (24.5)
Multiple Lamb Growth Rate	47.9 (50.2)	35.9 (29.1)	37.1 (32.7)	35.2 (26.9)
Later Lambing Dates	33.2 (30.0)	20.1 (20.8)	19.8 (23.0)	20.3 (19.6)
Controlled Set Stocking	36.6 (31.0)	62.5 (126.9)	81.0 (134.9)	50.5 (121.7)
Summer Pasture Control	69.9 (58.3)	100.4 (191.6)	134.2 (226.1)	77.9 (164.3)

- (a) **Maintaining Ewe Body Condition during Pregnancy**
All groups reported strong associations between the ewe body condition concept and multiple lamb survival supporting the research findings in chapter 6.
- (b) **Multiple Lamb Birthweight**
Experts reported a very strong association (11.6 ± 10.3) whilst Farmers reported an average belief comprising of a strong association for the Inexperienced group (21.8 ± 24.5) and a very weak association for the Experienced group (86.8 ± 252.8). The large variance displayed by the Experienced group requires further research.
- (c) **Multiple Lamb Growth Rate**
The Farmer group (35.9 ± 29.1) reported a moderately strong belief that multiple lamb survival was closely associated with multiple lamb growth rates. There was no significant difference between the experienced groups.
Experts considered there to be only an average association, although a large standard deviation was reported, (47.9 ± 50.2). No association has been reported in the research literature, suggesting farmers may be wrongfully associating the two concepts. Alternatively they may be associated as two outcomes resulting from a similar input (ie, maintenance of ewe body condition).
- (d) **Later Lambing Dates - High Lactation Feeding**
Farmers (20.1 ± 20.8) irrespective of experience level perceived a strong association between later lambing dates and multiple lamb survival. Experts reported a slightly weaker association (33.2 ± 30).
- (e) **Controlled Set Stocking at Lambing**
The Expert group (36.6 ± 31) associated controlled set stocking closely to multiple lamb survival reflecting the work of Kilgour (1981) on dam - off-spring bonding.

Farmers (62.5 ± 126.9) reported a weak association due to a very weak association reported by the Experienced group (81 ± 134.9) and an average association by the Inexperienced group. (50.5 ± 121.7). The large standard deviations indicate little consensus within each group.

(f) Summer Pasture Control

All groups hold weak to very weak beliefs about the association of summer pasture control to multiple lamb survival. (Table 8:4).

8.6.3 Maintaining Ewe Body Condition During Pregnancy

The peripheral belief measures relating to the ewe body condition concept are presented in Table 8:5.

Table 8:5 Peripheral beliefs for the Expert, Farmer, Experienced and Inexperienced groups relative to the concept Maintaining Ewe Body Condition during Pregnancy. (Standard Deviation)

Reference Concept	Expert	Farmer	Experienced	Inexperienced
Multiple Lamb Birthweight	21.2 (25.8)	25.5 (64.8)	43.8 (100.9)	13.7 (11.4)
Multiple Lamb Growth Rate	44.7 (45.0)	22.1 (22.5)	29.0 (29.5)	17.6 (15.3)
Later Lambing Dates	65.3 (48.7)	28.8 (32.6)	31.9 (26.6)	26.8 (36.2)
Controlled Set Stocking	134.0 (220.0)	34.5 (29.0)	39.6 (29.4)	31.0 (28.6)
Summer Pasture Control	78.1 (57.1)	57.4 (95.3)	61.3 (62.5)	34.9 (98.0)

- (a) Multiple Lamb Birthweights
All groups apart from the Experienced group (43.9± 100.9) reported strong associations between the ewe body condition concept and higher multiple lamb birthweights. The Experienced group result was not expected, but may reflect their ability to achieve higher condition scores at tuppung reducing the need for maintaining ewe body condition during pregnancy, (Robinson, 1983).
- (b) Multiple Lamb Growth Rates
Experts (44.7± 45) reported a weaker belief between the ewe body condition concept and multiple lamb growth rates than the Farmers (22.1± 22.5). This trend is enhanced by the belief strengths of the two experience groups with the lesser experience respondents reporting a higher belief strength.
- (c) Later Lambing Date - High Lactation Feeding
All farmers reported relatively strong belief strengths, whereas the Expert group (65.3± 48.7) perceived a moderately weak association. These findings are contrary to those of Geenty and Sykes (1983) who claim that higher condition scores during pregnancy reduced the need to lamb later.
- (d) Controlled Set Stocking
Significant differences existed between the Farmers (34.5± 29) and the Expert group (135± 220). All experience groups reported moderately strong associations, which requires further research.
- (e) Summer Pasture Control
Increasing levels of experience resulted in weaker beliefs with the Expert group (78.1± 57.1) reporting virtually no association. Farmers (57.4± 85.3) associated the concepts to a greater degree, but not strongly.

8.6.4 High Birthweights of Multiple Lambs

(a) Multiple Lamb Growth

The Expert (27.1± 26.7) and Farmers (29.4± 65.4) groups held moderately strong belief regarding the association between the multiple lamb growth rate and higher birthweights concepts. The Farmer group comprising of an average belief strength for the Experienced group (50.7± 99.1) and a very strong association by the Inexperienced group (15.6± 18.6). The Experienced group results suggest little or no influence of weight upon lamb growth rate, supported by the findings of Smeaton et al (1983).

Table 8:6 Peripheral belief measures involving Higher Birthweights of Multiple Lambs. (Standard Deviation)

Reference Concept	Expert	Farmer	Experienced	Inexperienced
Multiple Lamb Growth Rate	27.1 (26.7)	29.4 (65.4)	50.7 (99.1)	15.6 (18.6)
Later Lambing Dates	55.8 (46.3)	26.5 (28.1)	30.1 (31.4)	24.2 (25.9)
Controlled Set Stocking	98.6 (77.1)	53.5 (71.3)	70.6 (99.5)	41.7 (40.4)
Summer Pasture Control	85.6 (68.5)	87.6 (140.6)	79.6 (96.3)	77.9 (165.1)

(b) Later Lambing - High Lactation Feeding

Decreasing belief strength was reported from the groups with experience of high fecundity - Table 8:6, the relativity of which is predictable. The absolute values would suggest that the farmers appear to emphasise the lambing date component of the concept in that later lambing is likely to increase feed levels in late pregnancy increasing the birthweights.

- (c) **Controlled Set Stocking at Lambing**
Experts (98.6+ 77.1) consider no association between controlled set stocking and higher birthweights. With increasing experience farmers have weaker beliefs as was expected. No research has linked the two reference concepts.
- (d) **Summer Pasture Control**
All groups reported weak association between summer pasture control and higher birthweights.

8.6.5 Higher Growth Rates of Multiple Lambs

Table 8:7 presents the peripheral beliefs relating to the multiple lamb growth rate concept.

Table 8:7 Peripheral Belief associated with Higher Growth Rates of Multiple Lambs for the Expert, Farmer, Experience and Inexperienced Groups. (Standard Deviation)

Reference Concept	Expert	Farmer	Experienced	Inexperienced
Later Lambing Dates	10.5 (16.1)	15.6 (19.7)	18.1 (26.2)	14.0 (14.2)
Controlled Set Stocking	29.7 (27.1)	41.4 (129.4)	76.1 (203.6)	19.2 (19.7)
Summer Pasture Control	42.1 (70.9)	52.3 (90.8)	81.5 (136.8)	34.2 (34.5)

- (a) **Later Lambing - High Lactation Feeding**
All groups reported a strong association between the later lambing concept and high lamb growth rate, which is consistent with the findings of Thompson (1983 - a review).

(b) Controlled Set Stocking

The Inexperienced (19.2 \pm 19.7) and Expert (19.7 \pm 27.1) reported a strong association between the higher lamb growth rate concept and controlled set stocking at lambing time. The Experience group (76.1 \pm 203.6) reported a weak belief strength, but with little consensus. This may reflect the lower importance placed on lamb growth rates by the Experienced group who emphasised flexibility of lamb disposal systems.

(c) Summer Pasture Control

Both the Expert and Farmer groups reported average belief strengths, with the Inexperienced group (34.2 \pm 34.5) holding a moderately strong belief that summer pasture control is associated with high lamb growth rates.

The Experienced group (81.5 \pm 90.8) perceive virtually no association which is contrary to the research findings presented in Chapter 6 and requires further investigation.

8.6.6 Later Lambing - High Lactation Feeding

(a) Controlled Set Stocking

All groups reported relatively strong beliefs between the controlled set stocking and later lambing date concepts, (Table 8:8).

Table 8:8 Peripheral beliefs associated with the concepts of Later Lambing - High Lactation Feeding and Controlled Set Stocking for the Expert, Farmer, Experienced and Inexperienced groups. (Standard Deviation).

Reference Concept	Expert	Farmer	Experienced	Inexperienced
(a) <u>Later Lambing Date</u>				
Controlled Set Stocking	23.6 (19.6)	25.8 (25.9)	32.6 (31.9)	21.4 (20.5)
Summer Pasture Control	57.2 (33.6)	65.7 (141.7)	67.8 (99.6)	64.6 (164.5)
(b) <u>Controlled Set Stocking</u>				
Summer Pasture Control	44.4 (34.0)	63.1 (143.3)	61.2 (101.1)	64.2 (166.03)

(b) Summer Pasture Control

Later lambing was perceived as only weakly associated with summer pasture control by all groups, which is supported by the findings of Ulyatt (1978) who suggested high pasture cover levels at lambing coupled with the inability to hard graze pastures over lactation can increase pasture control problems. (Refer Table 8:8).

8.6.7 Controlled Set Stocking

(a) Summer Pasture Control

Farmers perceived a moderately weak association between Controlled Set Stocking at lambing and Summer Pasture control, whilst the Experts (44.4+ 34) perceived a slightly stronger belief association.

8.7.0 SPATIAL REPRESENTATION

Galileo methodology transforms an n -dimensional symmetrical matrix of $1/2(n+2)(n-1)$ interpoint distances (separations) to the corresponding n -dimensional matrix of scalar products, B^* , with the origin at the centroid of the points (see section 4.2.2.2). The coordinates of the n points are then derived by factoring the scalar products matrix B^* (See Appendix 1:0). The rank of B^* corresponds to the dimensionality of the space required to represent the n points. The dimensions of this space may be real or imaginary (corresponding to the number of positive and negative characteristic roots of B^* respectively). The coordinates of each point are given by the respective row elements of the factor matrix A , where $B^* = AA'$, with the origin at the centroid of the points. The columns of A (dimensions of the space required) are orthogonal and may be partitioned into real Euclidean space coordinates (corresponding to negative characteristic roots). Furthermore, the columns of A corresponding to real Euclidean space may be ordered so as to successively maximise the reduction in the variance of B^* . Thus the coordinates of the 'best' representation of the n points in real Euclidean 1-space are given by the elements in the first column of A ; the coordinates of the 'best' representation of the n points in real Euclidean 3-space (where there are at least two positive characteristic roots) are given by the elements in the first three columns of A enable a graphical representation of the n points in three dimensions.

Appendix 5:0 presents the factor matrices for the Expert, Farmers, Experienced and Inexperienced groups.

A glossary of the terminology used in relation to the spatical arraying of concepts is presented in Appendix 1:0.

8.7.1 Expert Group

The coordinate set for the Expert group derived from the matrix of interconcept distances is presented in Appendix 5:0. A total

of five real and five imaginary dimensions were necessary to spatially represent the ten reference concepts.

The first three dimensions account for 95.6% of the real space variance - refer to Figure 8:12. The warp factor of 1.70¹ for the Expert group indicates a relatively high level of inconsistency amongst the Expert groups measures.

Figure 8:12 Spatial Representation of Expert Cognitive Structure

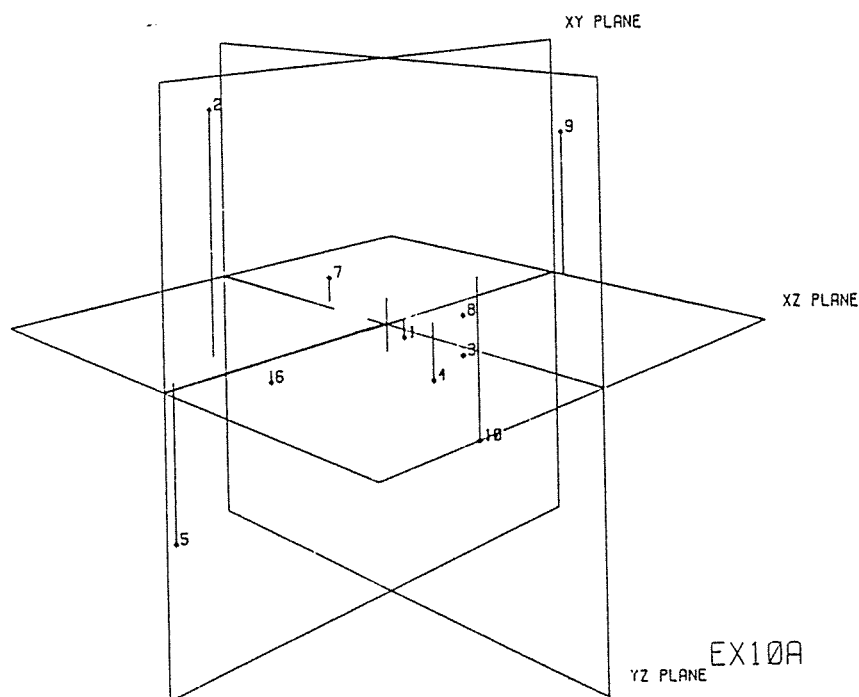

The trace of the Expert group matrix of scalar products totalled 12701 units.

Figure 8:12 spatially represents the first three real dimensions with concept numbers 1 and 4 being the 'act' and 'self' respectively.²

¹ See Appendix 6.0 for definition and interpretation.

² The presentation of only 3 dimensions provides a distorted representation of the overall 10 dimensions such that some distances in the average interconcept matrix (Table 8:1) will not correspond to the distances provided in the results section.

The overall attitude measure as depicted by the separation of concepts 1 and 4 is very strong. The self concept (number 4) being the concept most closely associated with the act.

On average, experts associated themselves closely with concepts 3 (improved multiple lamb survival), 8 (later lambing - high lactation feeding) with concepts 6 (higher lamb birthweight) and 10 (summer pasture control) the next closest, relative to the high fecundity production system specified.

In the first three dimensions, the act was most closely associated with concepts 3, 8 and 7 (higher multiple lamb growth rates) which is consistent with the findings of Rohloff (1984) and Owens (1985) that the two important components of successful high fecundity systems are survival and growth of multiple lambs.

8.7.2 Farmer Group

Appendix 5:0 presents the point coordinates associated with the average distances reported by the farmer groups, with seven real dimensions and three imaginary dimensions necessary to array the 10 reference concepts.

The first three real dimensions account for 83.4% of the total variance within the 'real' space (compared with 95.8% for the expert group). The trace of the total farmer sample equals 9788.2, considerably lower than 12701 reported for the expert group. The lower total variance and higher number of real dimensions associated with a lower warp factor (1.32), suggests that the total farmer sample displayed a greater degree of consistency in their belief and attitude measures.

The lower trace of the farmer group would indicate that on average, farmers had less capability to discriminate amongst reference concepts (as each individual makes finer discriminations, distance variance increases, resulting in a larger trace - Stoyanoff and Fink, 1981).

Experts would have a greater amount of information with respect to the act and reference concepts which, when associated with the finer discrimination, would increase the magnitude of the trace.

The higher proportion of real dimensions for the farmer group indicates that the farmer group had an increased level of differentiation of the reference concepts, due largely to the Experienced farmer group as presented in section 8:5:2 and 8:5:3 above with respect to the Act-concept and self-concept measures. Stoyanoff and Fink (1981) claim that a measure of the differentiation can be determined by the number of dimensions needed to account for a significant proportion of variance.

A lower warp factor for the farmers, results from their ability to establish relationships among the reference concepts and is consistent with a higher level of integration, (Stoyanoff and Fink, 1981). Alternatively this could be interpreted as farmers possessing less information - knowledge about the act to integrate, resulting in a lower warp factor and smaller size of the Trace. A larger amount of information about an act and the associated reference concepts, the more difficult it would be to integrate this into a cognitive domain, especially in a farm management context where a range of inputs and outcomes associated with the act interact with a variable biological production system. This was in part indicated by the differences presented in Figures 8:1, 8:2 and 8:3 where Experienced farmers on average, differentiated between reference concepts to a greater extent than the Inexperienced farmers and also the Expert group.

The notion of the warp factor declining over time due to consistency 'forces' should be considered over a long time frame. As respondents learn of an act and then gain knowledge about the range of inputs and outcomes associated with the act, the warp factor may increase prior to any reduction. Given the dynamic nature of management systems and the associated biological variation, it is possible that the warp factor may not decline over time, as more knowledge is developed. From this it is hypothesised that both with and without knowledge the natural

inclination is to 'lump concepts together'. With experience, perceptions are likely to be challenged and hence the trace of B^* increased, since outcomes of the system actually implemented won't align with the perceived outcomes of those of the Experts. As managers are faced with the situation where results are divergent from expectations the expectations are adjusted such that future similar results 'fit' the expectations (ie equivalent to the Cognitive experimental leaning theories discussed in chapter 2). Eventually as managers have learnt the production-management systems their belief and attitudes should align with those of the Expert group (assuming the Experts do in fact represent the 'real world' situation) and the subsequent Trace of the B^* should decrease in size.

Figure 8:13 Spatial Representation of Farmer Cognitive Structure

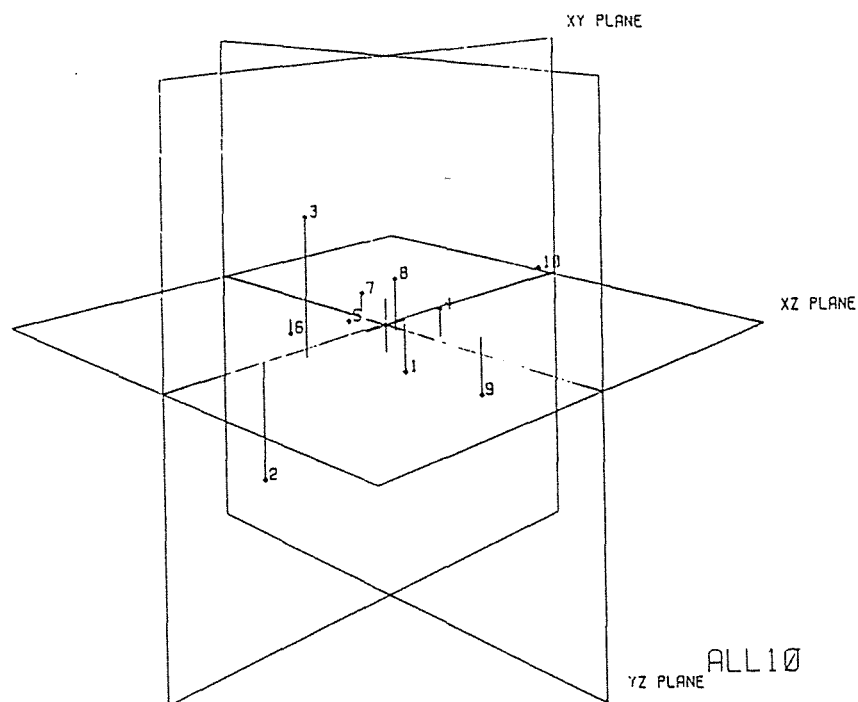

Figure 8:13 presents the first three dimensions of the farmer group spatial representation. The overall attitude distance is greater than those for the expert group.

Farmers on average associate themselves with concepts 7, 8 and 9 (Multiple lamb growth, Later Lambing, Controlled set stocking at lambing), all of which are primarily 'growth of lambs' orientated whereas Experts tended to associate themselves with survival of lambs and to a lesser extent lamb growth.

The act was associated closely with concepts 9, 8 and 5 (Controlled Set Stocking; Later lambing; Maintaining ewe body condition during pregnancy). The difference between the Expert and Farmer principal beliefs is that experts weight multiple lamb survival and growth rate concepts heavily whereas farmers on average weight controlled spring set stocking (be an input to lamb growth) and maintenance of ewe body condition during pregnancy (an input to lamb survival). This would suggest that Experts emphasise general concepts whilst farmers may emphasise the practical components to achieve the same concepts.

8.7.3 Experienced Farmer Group

The Experienced farmers point co-ordinate set is presented in Appendix 5:0 with six real dimensions and four imaginary dimensions required to spatially array the ten reference concepts. This group has a higher level of differentiation than the Expert group, but less than the overall and Inexperienced farmer groups, (see below), ie 4 - 5 dimensions were required to account for 85% of the real space variance.

The trace for the Experienced group was 14697.2, the highest of the four groups analysed. The high trace figure most likely result from the Experienced respondents knowledge of the input and outcome associations gained from previous experience enabling a greater capacity to discriminate between reference concepts. Alternatively Woelfel and Fink (1980) suggest that respondents with a large trace are likely to be confused with respect to the

meaning of the reference concepts. This could be supported by the standard deviation measures in Tables 8:1 to 8:8 which are greater than for the other groups. The hypothesis that with further experience the cognitive perceptions of Experienced managers would align to the real world situation and hence reduce the Trace of B^* could be examined by further study of farmer concepts, where the categorisation was according to years of experience with high fecundity production systems.

The 'Experienced' group would appear to integrate the associations between the 10 reference concepts to a greater degree than both the Expert and Inexperienced groups, ie warp factors 1.4, 1.7, 1.42 respectively. Over time the cognitive structure of the Farmers groups is hypothesised to move towards that of the Expert groups as representative of the 'real world'. The high warp factor of the Expert group (1.7) suggests that the real world requires a combination of real and imaginary Euclidean space to represent it. The low warp factor for the Experienced and Inexperienced group (ie 1.4 and 1.42) suggests that farmers perceptions are based on more linear Euclidean space to that of the Experts.

Figure 8:14 Spatial Representation of Experienced Farmers Cognitive Structure.

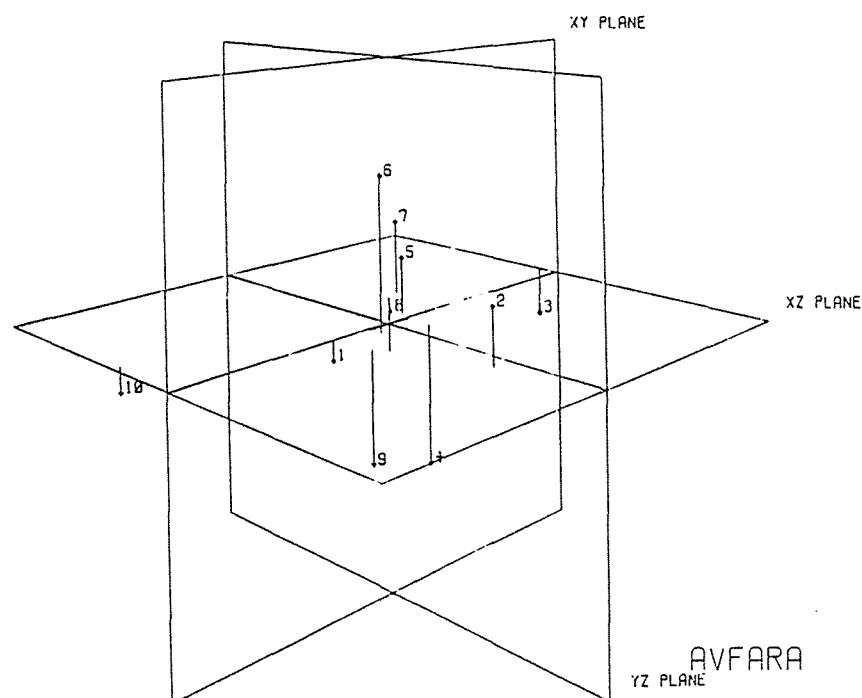

Figure 8:14 presents the first three real dimensions of the Experienced groups spatial representation. The act is most closely associated with concepts 8, 5 and 9, similar to the overall farmer group. Experienced farmers perceive the act as being closer to the lamb survival concept than the lamb growth (although neither is closely associated with the act), ie Experienced farmers are tending towards the cognitive structure of the expert group.

The self concept is most strongly associated with concept 9, 3, 8 which supports the emphasis being on survival and the growth factors similar to the attitudes reported by the Expert group.

8.7.4 Inexperienced Farmer Group

The Inexperienced farmers co-ordinate set (refer Appendix 5:0) required six real dimensions and four imaginary dimensions to spatially arrange the reference concepts as did the Experienced farmers. The first three dimensions account for 91.1% of the total variance, considerably more than for the Experienced group, (85.7%). The smallest trace for all the analyses - 7893 was obtained from the Inexperienced group, suggesting a lower level of discrimination between concepts. This could reflect a lower level of information on the act for the Inexperienced group, a conclusion also supported by section 8.5.4 and Figures 8.2 and 8.3.

A warp factor lower than the Experts group, ie 1.42 but marginally higher than the Experienced group further suggests that the Expert group may not optimally reflect the real world system, or alternatively indicates experts have access to greater amounts of information which they are required to integrate³.

³ This is supported by the analysis of 14 reference concepts resulting in warp factors greater than 2 for all groups.

Figure 8:15 Cognitive Structure of the Inexperienced Farmer Group

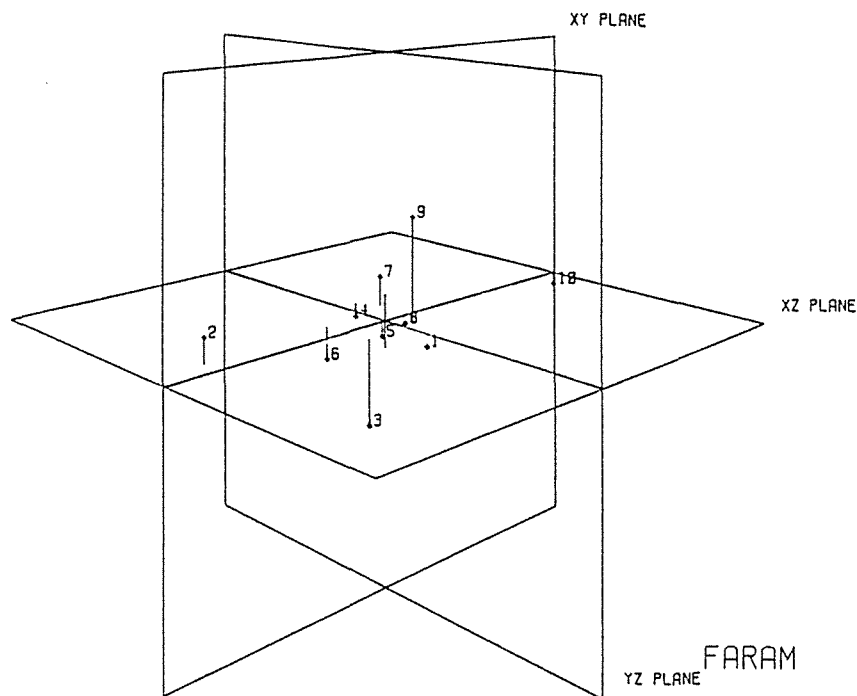

Figure 8:15 presents the spatial representation of the reference concepts by the Inexperienced group.

The act most closely associated with concepts 5, 8, 7, 6 (Maintaining Ewe Body Condition, Later Lambing, Multiple Lamb Growth Rates and Lamb Birthweights), which reflects an emphasis on both lamb growth rate and more indirectly lamb survival.

The self concept was most closely associated with concepts 5, 8, 7, 6 which is weighted towards the growth rate concepts as opposed to the survival - growth rate concepts of the Experienced groups.

8.8.0 SUMMARY

The quantitative measures of the overall and evaluative attitudes; the principal and peripheral beliefs as obtained from the Galileo measurement system are presented.

The measures for each of the two levels of farmer experience in high fecundity systems are presented, in an attempt to identify differences in the cognitive structures as predicted by the Cognitive Experiential Learning theories and the management behavioural models presented in chapter 2.

Several differences are identified as existing between the Expert group (as representative of the real world) and those farmers who have and have not experienced a high fecundity production system. The overall attitude measures reflected increasing strength with experience as predicted. Belief measures were also discussed in terms of the research literature.

Chapter 8 concluded with a graphic interpretation of the cognitive structure for each experience level group. This highlighted the different degrees of integration of information, as experience of high fecundity was obtained. It was hypothesised that Experts and Inexperienced farmers had small traces of B* due to different reasons viz.

- (1) Experts integrated the input-outcome-act and self concepts to a greater degree, which was stable as it represented the real world.
- (2) Inexperienced farmers had little information regarding the concepts and as such it didn't necessitate integration.

Experienced farmers reported a large trace of B* suggesting that as more information becomes available greater difficulty in integrating this with existing cognitive beliefs/attitudes is experienced. Overtime as the system is learnt the trace would again tend to decrease.

The hypothesis fits the cognitive experiential learning theories discussed in chapter 2.

Chapter 9 presents the alternative comparative analyses utilised to highlight the differences between the cognitive structures of each group.

CHAPTER NINE: COMPARATIVE ANALYSIS

9.0.0 INTRODUCTION

Chapter 9 presents the analysis of the data, presented in chapter 8, to determine how the three groups (Hi lamb Experienced, Hi lamb Inexperienced; Experts) vary in their cognitive structures.

Firstly the spatial representations resulting from the Galileo multidimensional scaling algorithm are compared by using the Procrustes rotation analysis option within the Galileo TM software. MDA is then applied to the principal belief and evaluative attitude measures to determine which reference concepts characterise each group of respondents.

The principle belief and evaluative attitude measures are then combined as suggested by Fishbein and Ajzen (1979) and MDA is used to characterise the three groups of respondents.

9.1.0 PROCRUSTES COMPARATIVE ANALYSIS

The ratio basis of the Galileo measurement system enables the Procrustes rotation systems discussed in chapter 4 to be utilised in order to compare the spatial representations of each group in an attempt to identify any differences in the respective cognitive structures.

To compare co-ordinate sets directly requires the orientation of the dimensions in each data set to be similar before the position of each concept within each co-ordinate set can be compared.

For an analogy, consider two similar geographic maps, one with Traditional West-East, North-South dimensions, the other with dimensions off-set by 30 degrees. Comparison of both once the dimensions are aligned would result in the conclusion that both maps differed significantly. Procrustes rotation rotates a subset of points in each map to a best fit criterion, (see chapter 4).

The remaining points are then rotated using the same transformations, which in the above example would result in total similarity.

To investigate the Procrustes rotation routine with the Galileo TM Program, the three sets of data, ie Experts, Inexperienced, Experienced groups, were compared in a series of two way comparisons. The concepts of High Fecundity and Self were selected as stable concepts, in that these concepts were rotated to a best fit position, with the same transformation then used to rotate the remaining reference concepts free of the best fit criterion, ie to obtain a common co-ordinate system for the two groups being compared.

9.1.1 Comparison of the Experienced and Inexperienced Group

The result of the Procrustes rotation is two sets of co-ordinates, (one for each group) that are associated with a common orientation of the dimensions. Having oriented the co-ordinate sets onto a common set of axes, the distance between concepts and the angle between their position vectors provide information on the similarity of the coordinate sets between the two groups for each concept.

The distance separating concept A in the two co-ordinate sets is given by the expression:

$$\overline{AxAy} = [(X_1 - Y_1)^2 + (X_2 - Y_2)^2 + \dots + (X_n - Y_n)^2]^{1/2}$$

Where X_i is the co-ordinate of concept A in the i th dimension of the X co-ordinate set, and Y_i is the co-ordinate of concept A in the i th dimension of the Y co-ordinate set.

Where the k th dimension is imaginary, the expression $(X_k - Y_k)^2$ is subtracted in the above formula.

Where $\sum_i (X_i - Y_i)$, the distance \overline{AxAy} is given as $|\sum_i (X_i - Y_i)^2|^{1/2}$.

Figure 9:1 Two Dimensional Representation of Concepts Located Within Two Co-ordinate Sets Based Upon Common Dimensions.

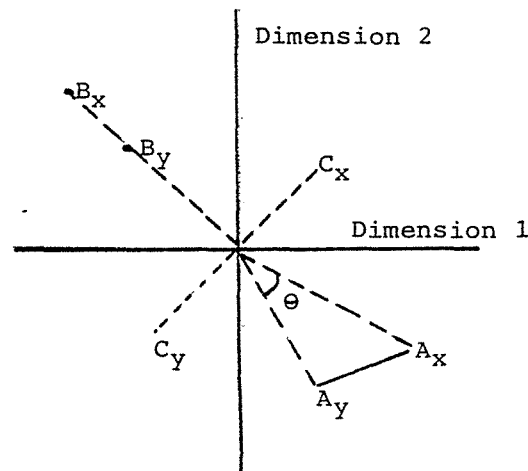

Where the co-ordinates of $A_x:(X_1, X_2)$ and $A_y:(Y_1, Y_2)$. Then the separation (distance) between concept A in the two co-ordinate sets X and Y is given by:

$$\overline{A_x A_y} = [(X_1 - Y_1)^2 + (X_2 - Y_2)^2 + \dots + (X_n - Y_n)^2]^{1/2}$$

Concept B is separated but perfectly correlated ($\theta=0$, $\cos \theta=1$). Concept C is also separated, but perfectly negatively correlated ($\theta=180$), $\cos \theta=-1$). The scalar product formula can be used to obtain $\cos \theta$:

$$(\overline{O A_x}) (\overline{O A_y}) = \cos \theta = \frac{1}{2} [\overline{O A_x}^2 + \overline{O A_y}^2 - \overline{A_x A_y}^2]$$

$$\text{Thus, } \cos \theta = \frac{X_1 Y_1 + X_2 Y_2}{[(X_1^2 + X_2^2) (Y_1^2 + Y_2^2)]^{1/2}}$$

It is clear that both the distance between two points and the cosine of their angle of separation (θ) are required to fully describe the nature of their separation.

The distance between a concept in the two co-ordinate sets can be determined using vector algebra, ie the sum of the squared differences on each dimension of the two co-ordinate sets for each concept.

$$\text{ie, Concept A} = (X_1 - Y_1)^2 + (X_2 - Y_2)^2 + \dots + (X_n - Y_n)^2$$

where X = Co-ordinates of concept A on the dimensions of co-ordinate set X.

Y = Co-ordinate of concept A on the dimensions of co-ordinate set Y.

N = 1 to 10.

= Separate dimensions ie no set of co-ordinates.

Where imaginary dimensions exist, the signs in the above summations are reversed and where the square root of a negative resultant is indicated, we set this equal to the negative of the square root of the absolute value of the resultant.

In general terms the cosine θ can be denoted by:

$$\text{Cosine } \theta = \frac{X'Y}{[|X'X| |Y'Y|]^{1/2}}$$

where X and Y are the concept co-ordinate vectors corresponding to each co-ordinate set. The distances separating the concepts in the rotated or common (best-fit) space is presented for the Experienced and Inexperienced former groups in Table 9:1¹.

Table 9:1 Distances separating reference concepts in the Cognitive structures of the Experienced and Inexperienced Groups. (All 10 Dimensions)

	Separation (Distance)	Correlation (cos θ)
Concept 1 (High Fecundity)	16.070	>1.0
Concept 2 (Reduced Stocking Rate)	42.458	0.2117
Concept 3 (Multiple Lamb Survival)	85.967	<-1.0
Concept 4 (Self)	-16.070	>1.0
Concept 5 (Ewe Body Condition)	49.618	0.3022
Concept 6 (Multiple Lamb Birthweight)	67.902	-0.3276
Concept 7 (Multiple Lamb Growth Rates)	49.509	0.3290
Concept 8 (Later Lambing)	20.343	0.0226
Concept 9 (Set Stocking)	52.836	<-1.0
Concept 10 (Summer Pasture Control)	114.527	<-1.0

¹ A full printout of the rotated co-ordinate sets is presented in Appendix 7:0.

The mean distance between all points in space 1 and their counterparts in space 2 is 45.102.

NB Where the effect of imaginary dimensions is large, the correlation between points (the cosine of θ) may not be defined, ie $-1.0 > \cos\theta > 1.0$.

The stable concepts (No's 1 and 4) have the same separation, as these concepts are transformed according to a least squares best-fit criterion.

The concepts with the smallest separation within the rotated space were concept 8, ie Later lambing, (20.3 units) and concept 2, ie Reduced stocking rates (42.5 units). Although closely located, correlations associated with these concepts are low and positive. The correlation for later lambing is virtually nil, ie the angle between the position vectors for each co-ordinate equals 88.7 degrees.

A comparison of the distances reported in Table 9.1 with the graphic representation of the act-concept; self-concept distances in Figures 8.4 to 8.12 indicates the influence of incorporating peripheral beliefs within the analysis.

The remaining concepts are separated by relatively large distances considering the standard separation of 100 units.

Multiple lamb survival was most widely separated reflecting the emphasis placed on lamb survival by the Experienced group relative to the Inexperienced group.

The correlations between the co-ordinate sets are on the whole quite low (range -0.3 to 0.3) which is in part reflected by the average distance separating concepts in each co-ordinate set being 45.1 units, which is large relative to the original criterion separation of 100 units. Differences in the cognitive structure of the two groups would appear to be quite large.

The separation of each concept within the common 'space' and their associated correlations for the first five real dimensions is presented in Table 9:2.

Table 9:2 Analysis of Concept separations between the Experienced and Inexperienced farmer groups (first 5 real dimensions).

	Separation (Distance)	Correlation (cos θ)
Concept 1 (High Fecundity)	0.872	0.999
Concept 2 (Reduced Stocking Rate)	51.966	0.518
Concept 3 (Multiple Lamb Survival)	97.240	-0.811
Concept 4 (Self)	0.872	0.999
Concept 5 (Ewe Body Condition)	53.633	0.136
Concept 6 (Multiple Lamb Birthweight)	68.001	0.030
Concept 7 (Multiple Lamb Growth Rates)	54.444	0.203
Concept 8 (Later Lambing)	28.475	0.519
Concept 9 (Set Stocking)	58.047	0.469
Concept 10 (Summer Pasture Control)	116.002	-0.469

For the first five real dimensions the procrustes rotation has resulted in almost no point separation ($\cos \theta=1$) for the concepts of Act and Self. Given this alignment, the concept most closely associated by the two groups is later lambing (concept 8), both in terms of distance and positive correlation. (This compares with a smaller distance (20.34 units) and a smaller positive correlation (0.0226) for all ten dimensions.)

The concepts least closely associated (large separation distances and negative correlations) are multiple lamb survival and summer pasture control.

9.1.2 Procrustes Rotations of the Expert group with the Experienced and Inexperienced groups

Chapter 8 presented the spatial representation of the Expert group and the two performance groups, indicating that each of these groups required 5, 6, 6 real and 5, 4, 4 imaginary dimensions respectively to fully represent the input data.

Appendix 7.0 and 8.0 presents the results of the Procrustes rotation involving viz.

- 1 Experienced versus Expert groups.
- 2 Inexperienced versus Expert groups.

These analyses indicated a software problem in that scalar products calculations were based on the co-ordinate loadings on dimensions 1 to 11 for the Experienced - Expert group comparison, whereas the magnitude calculations include the co-ordinate loadings on dimension 11 as artificial. This is in fact not the case as the artificial dimensions are number 7 and 6 for the Experienced and Expert groups respectively. Which are placed here as they account for minimal variance in the co-ordinate set whereas dimension eleven accounts for the maximum variance in the imaginary dimension set.

To overcome this problem these comparisons are presented for the first five real dimensions only.

The distance separations for the Experienced and Expert groups is presented in Table 9:3.

Table 9:3 Concept Separations and the Associated Correlations for the common rotated space involving the Experienced and Expert groups. (First 5 real dimensions only.)

	Separation (Distance)	Correlation ($\cos\theta$)
Concept 1 (High Fecundity)	11.468	0.999
Concept 2 (Reduced Stocking Rate)	60.855	0.617
Concept 3 (Multiple Lamb Survival)	89.259	-0.316
Concept 4 (Self)	11.468	0.999
Concept 5 (Ewe Body Condition)	108.270	-0.620
Concept 6 (Multiple Lamb Birthweight)	88.464	-0.345
Concept 7 (Multiple Lamb Growth Rates)	47.102	0.513
Concept 8 (Later Lambing)	40.465	0.131
Concept 9 (Set Stocking)	86.889	-0.372
Concept 10 (Summer Pasture Control)	98.306	-0.375

Experienced farmers most strongly "disagree" with the Expert group over multiple lamb survival, ewe body condition, multiple lamb birthweight, controlled set stocking and summer pasture control. Later lambing and Multiple lamb growth rates were most closely associated although the association was not strong.

This data adds to that presented in Figures 8:4 to 8:12, except that the above distances are more "accurate" given that peripheral beliefs are incorporated; the first 5 real dimensions are used and that the two co-ordinate sets are rotated onto a common set of dimensions.

The Inexperienced group comparison with the Expert group is presented in Table 9:4.

Table 9:4 Concept Separations and the associated correlations for the common rotated space involving the Inexperienced and Expert groups. (First 5 real dimensions only.)

	Separation (Distance)	Correlation (cos θ)
Concept 1 (High Fecundity)	10.629	0.9998
Concept 2 (Reduced Stocking Rate)	84.871	0.2015
Concept 3 (Multiple Lamb Survival)	37.357	0.0156
Concept 4 (Self)	10.629	0.9998
Concept 5 (Ewe Body Condition)	66.353	-0.2590
Concept 6 (Multiple Lamb Birthweight)	52.573	-0.1198
Concept 7 (Multiple Lamb Growth Rates)	42.766	-0.4096
Concept 8 (Later Lambing)	47.275	-0.8607
Concept 9 (Set Stocking)	43.624	0.7873
Concept 10 (Summer Pasture Control)	47.809	0.5660

Inexperienced farmers most strongly disagree with the Expert group with respect to the concepts of Reduced Stocking Rate, Ewe Body Condition, Multiple Lamb Birthweight. The remaining concepts being only moderately associated with separation distances all exceeding 35 units. In addition to the large separation associated with the concept Multiple Lamb Birthweight this concept displayed very little correlation (this also holds for the Lamb Survival concept).

Overall the Inexperienced group reported concepts that are more closely associated to the Expert group than the Experienced group. (i.e. smaller separations), although the level of correlation for most concepts is low to moderate (with the exception of Later Lambing and set stocking).

9.2.0 MULTIPLE DISCRIMINANT ANALYSIS

Multiple Discriminant Analysis (MDA) develops discriminant functions (a maximum of one less than the number of groups to be discriminated) in which the independent variables, ie principal beliefs, evaluative attitudes, and the overall attitude index (as predicted by equation 2.3, chapter 2) are weighted (discriminant co-efficients) such that the resultant function scores maximally in separating the groups, ie Experts, Experienced and Inexperienced farmers. The raw data consists of independent variable values for each member of each group. The principal belief and evaluative attitude measures for each individual were extracted from the Galileo data set and each distance subtracted from a constant, so that large (rather than small) values would represent strong beliefs or attitudes.

As discriminating functions are computed, the capability of the remaining information to discriminate between the groups is reduced. A measure of the discriminating information remaining at any stage is Wilks' Lambda².

The initial value of Wilks' Lambda gives a measure of the discriminating information in the data set prior to computation of any discriminating functions.

The SPSSX programme used in this analysis (Nie et al., 1979) provides two measures for judging the importance of computed discriminating functions. The process of computing discriminant

² Wilks Lambda is an inverse measure of the discriminating power in the original variables - the larger lambda is, the less discriminating information remaining. Lambda can be transformed into a chi-square statistic for an easy test of statistical significance ie to determine the statistical significance of computing further discriminant functions from the remaining information.

functions involves factorisation of the independent variable variance, covariance matrix and the sum of the eigenvalues (eigenroots, characteristic roots) equals the total variance in the discriminating variables. Thus the ratio of the eigenvalue associated with a discriminant function (eigenvector) expressed as a percentage of the total sum of eigenvectors, gives a measure of the importance of the associated function. As was the case for multidimensional scaling, successive discriminant functions can be obtained so as to maximise the reduction in the remaining variance. If we conducted an analysis of variance on the individual scores computed from a discriminant function and expressed the resulting "between group sum of squares" as a proportion of the "total sum of squares" we would obtain the square of the canonical correlation for the discriminant function. Since discriminant functions are orthogonal, both measures described can be used to judge the importance of individual discriminant functions.

9.2.1 Principal Belief Discriminant Functions

Table 9.5 Presents information in the discriminating power of the individual principal beliefs. The value for the F-statistic is obtained from an analysis of variance on the individual variable.

Table 9:5 Discriminating Power of Individual Principal Beliefs

Reference Concept	Wilks' Lambda	F.	Significance
Reduced Stocking Rate (2)	0.81955	8.477	0.0005
Multiple Lamb Survival (3)	0.91169	3.729	0.0285
Ewe Body Condition (5)	0.94114	2.408	0.0967
Multiple Lamb Birthweight (6)	0.94997	2.028	0.1386
Multiple Lamb Growth Rate (7)	0.90485	4.001	0.0222
Later Lambing (8)	0.97130	1.138	0.3259
Controlled Set Stocking (9)	0.95853	1.666	0.1958
Summer Pasture Control (10)	0.99340	0.255	0.7749

Only the principal beliefs associated with the concepts Reduced Stocking Rate, Multiple Lamb Growth Rates, Multiple Lamb Survival and Maintenance of ewe body condition displayed discriminating ability at the 10% level or less. Reduced stocking rates displayed a very highly significant ($P = 0.0005$) discriminating ability.

Table 9:6 presents the results of MDA applied to the data on the eight principal beliefs.

Table 9:6 Canonical Discriminant Functions based upon Principal Beliefs

Discriminant Function	Eigenvalue	Percent of Variance	Canonical Correlation	Wilks' Lambda	Signif. (P)
0	-	-	-	0.5927	0.0013
1	0.4732	76.52	0.5668	0.8732	0.1906
2	0.1452	23.48	0.3560	-	-
Standardized Canonical Discriminant Function Coefficients					
Concept			Function 1	Function 2	
2	Reduced Stocking Rate		-1.02614	-0.01352	
3	Multiple Lamb Survival		-0.38075	0.69172	
5	Ewe Body Condition		-0.02453	0.48727	
6	Multiple Lamb Birthweight		0.27000	0.32269	
7	Multiple Lamb Growth Rate		0.46777	-0.06157	
8	Later Lambing		0.11109	-0.05600	
9	Set Stocking		0.48840	0.02286	
10	Summer Pasture Control		0.29961	-0.01858	

Before any functions were removed, Wilks' lambda was 0.593 (significant at the one percent level), indicating that considerable discriminating power exists in the variables being used.

The first function removed the significant discriminating power significant only at the 19 percent level ($\lambda = 0.8732$). The importance of the first discriminant function is also indicated by the percentage of variation explained (76.52).

The absolute value of the discriminant coefficients indicates the degree each principal belief loads on to each function, with the sign of the coefficient indicating a positive or negative loading. Discriminant function one has the beliefs reduced stocking rate (-1.026), controlled set stocking (0.4884) multiple lamb growth rates (0.468) and multiple lamb survival (0.381) loaded heavily on it.

The mean discriminant scores for each group is presented in Table 9:7 along with the 95% confidence intervals determined by the ANOVA procedure³. The significance of the group means was tested by an ANOVA analysis for the individual discriminant scores. The group means showed highly significant differences on both discriminant functions. ($P = 0.0000$; $P = 0.0005$ for the first and second functions respectively).

The squared Canonical correlations indicate the proportion of variance in the discriminant function explained by the groups. The groups account for 32% and 12.6% of the variance in the first and second functions respectively.

³ ANOVA procedure of the SPSSX package (Nie et al 1979)

Table 9:7 Mean Discriminant Scores of the Principal Beliefs for the Expert, Experienced and Inexperienced Groups.

Discriminant Function	Group	Mean	95 PCT Confidence Interval	Signif. F Prob
One	Exp.	-0.0952	-0.6121 to 0.4217	0.0000
	Inexp.	-0.5348	-0.7366 to -0.330	
	Expert	1.1617	0.5463 to 1.7771	
Two	Exp.	-0.5686	-1.1947 to 0.0575	0.0054
	Inexp.	0.2733	0.0506 to 0.4959	
	Expert	0.1861	-0.1800 to 0.5522	

The discriminant functions can be considered as orthogonal axes onto which the discriminating variables (principal beliefs) can be mapped by using their discriminant coefficients as co-ordinates. Figure 9:3 presents the discriminant function graph for Principal beliefs.

The first discriminant function correlates highly with reduced stocking rates (-0.672); controlled set stocking (0.302); later lambing date (0.243) and Lamb Growth Rates (0.208) and these beliefs therefore contribute most to the differentiation of the groups.

The second function correlates highly with multiple lamb survival (0.81); multiple lamb growth rates (0.758), ewe body condition (0.627) and multiple lamb birthweights (0.581).

Each group can be represented on the co-ordinate set (as defined by the discriminant functions) using the mean discriminant scores on each function. At the 95% confidence interval the mean group scores were significantly different⁴.

⁴ The significance of group separation can be approximated by drawing 95% confidence circles about the mean. The radius of the confidence circle is approximated by $\sqrt{\frac{5.99}{n}}$ where n equals the number in the respective groups. (Hassard - cited in A.M.P. Dick, 1985).

'Reduced stocking rate', the belief that loads heaviest onto discriminant function one and correlates highest with this function, is viewed as strongly negative⁵ by the Expert group, neutral to slightly negative by the Experienced group and very positive by the Inexperienced group.

Controlled set stocking ordered the groups as Experts very positive, Experienced slightly negative and the Inexperienced very negative.

Figure 9:2 Multiple Discriminant Analysis based on the Principal belief measures for the Expert, Experienced and Inexperienced Groups.

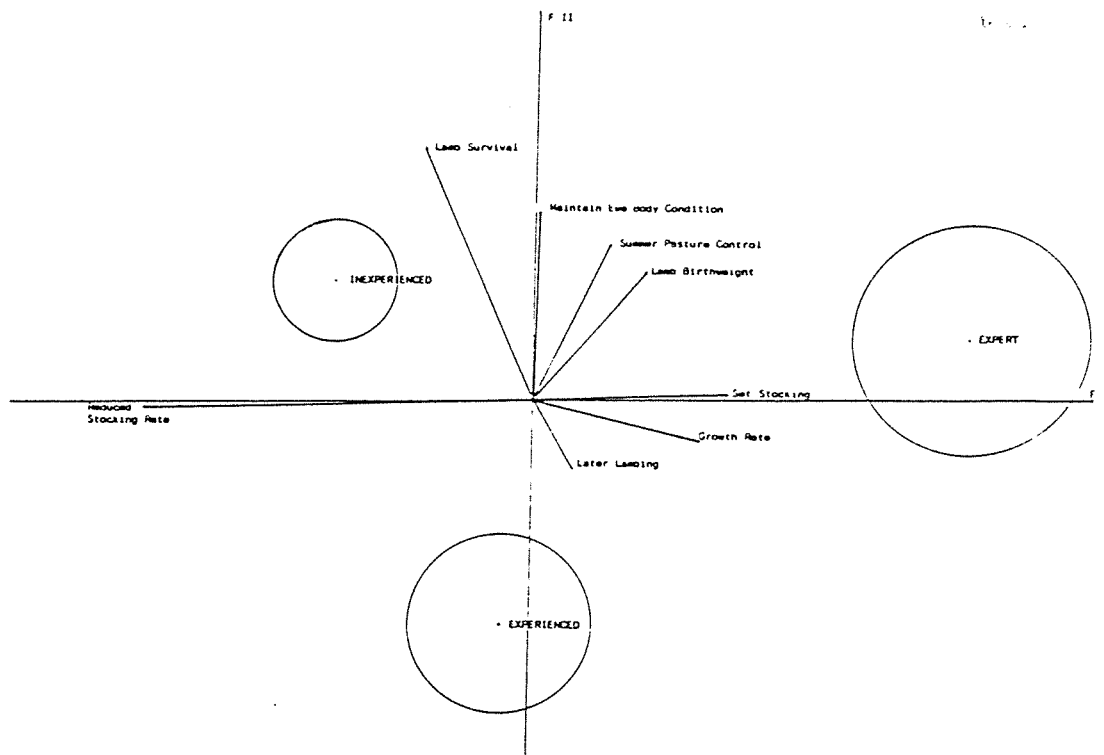

⁵ As the original distances were subtracted from a constant either the loadings should be reversed or the Principal belief meaning reversed to be consistent with the Galileo analysis.

9.2.2 Evaluative Attitude Discriminating Functions

The evaluative attitudes on reduced stocking rates, lamb growth rate and lamb survival displayed significant discriminating power ($p = 0.0078$ and $P = 0.0145$ $P = 0.0891$ respectively), whilst the remaining evaluative attitudes individually displayed no significant discrimination between the groups - refer Table 9:8.

Table 9:8 Reference Concept Discriminating Power within the Evaluative Attitude Dataset

Wilks' Lambda (U-Statistic) and Univariate F-Ratio with 2 and 76 Degrees of Freedom.

Concept	Wilks Lambda	F.	Significance
Reduced Stocking Rate	0.88024	5.170	0.0078
Multiple Lamb Survival	0.89461	4.477	0.0145
Ewe Body Condition	0.97277	1.064	0.3503
Multiple Lamb Birthweight	0.95730	1.695	0.1905
Multiple Lamb Growth Rate	0.93835	2.497	0.0891
Later Lambing	0.95412	1.827	0.1678
Controlled Set Stocking	0.99110	0.341	0.7121
Summer Pasture Control	0.98210	0.692	0.5034

Prior to removing any discriminant functions, Wilks Lambda was 0.593 (significant at the two percent level), indicating that discriminating power exists in the variables.

Table 9:9 Canonical Discriminant Functions for Evaluative Attitudes

Discriminant Function	Eigenvalue	Percent of Variance	Canonical Correlation	Wilks' Lambda	Signif. (P)
0	-	-	-	0.5944389	0.0017
1	0.37953	63.36	0.5245147	0.8200466	0.0448
2	0.21944	36.64	0.4242092	-	-
Standardized Canonical Discriminant Function Coefficients					
Concept			Function 1	Function 2	
2	Reduced Stocking Rate		0.7771	-0.2100	
3	Multiple Lamb Survival		-0.7823	-0.4728	
5	Ewe Body Condition		0.9833	-0.6214	
6	Multiple Lamb Birthweight		-0.8816	1.0743	
7	Multiple Lamb Growth Rate		0.2120	0.5608	
8	Later Lambing		-0.2184	0.5408	
9	Set Stocking		0.2492	-0.1557	
10	Summer Pasture Control		0.2693	0.1954	

The first discriminant function removed only part of the significant discriminating power within the data (with the residual discriminant power significant at the 4 percent level).

The two discriminant functions account for 63 and 37 percent of the variance within the dataset respectively, indicating the contribution of both functions in separating the groups.

Evaluative attitudes regarding ewe body condition, lamb birthweight, multiple lamb survival and reduced stocking rate loaded most heavily onto function one, whilst lamb birthweight, ewe body condition, lamb growth rate and later lambing loaded heavily onto the second function.

The mean group discriminant scores (refer Table 9:10) ordered the groups as Expert, Experienced and Inexperienced on the first function and as Experienced, Inexperienced and Experts on the second function. The group discriminate scores displayed highly significant differences on both functions (ANOVA $P = 0.0000$, $P = 0.0000$, $P = 0.0005$).

Table 9:10 Mean Discriminant Scores for Attitude Measures for the Expert, Experienced and Inexperienced Groups.

Discriminant Function	Group	Mean	95 PCT Confidence Interval	Signif. F Prob
One	Exp.	-0.1826	-0.5397 to 0.1745	0.0000
	Inexp.	0.59524	0.2612 to 0.9292	
	Expert	-0.8971	-1.4702 to -0.3240	
Two	Exp.	-0.6815	-1.2646 to 0.0985	0.0005
	Inexp.	0.2175	-0.0535 to 0.4.886	
	Expert	0.4487	0.0951 to 0.8023	

Figure 9:3 presents the discriminant function graph for the evaluative attitude data, with the difference to the principal belief analysis, that both functions contribute significantly towards group discrimination.

Both the Expert and Experienced groups displayed negative attitudes towards reduced stocking rates whilst the evaluative attitude was moderately positive.

Lamb survival was associated closely and positively by the Experienced and Expert groups.

The second discriminant function was most strongly correlated with the concepts lamb birthweight (0.45) and lamb growth rate (0.53).

Both of these concepts ranked the Experts and Inexperienced groups as slightly positive in their attitudes, with the Experienced group reporting a negative attitude to both.

All group means were significantly different at the 95% confidence interval level.

9.2.3 Overall Attitude Index Discriminant Functions

The overall attitude index, as computed by equation 2:3, comprises the sum of the product of the Principal belief multiplied by the Evaluative attitude for each reference concept. Each of the components of this index ($a_j b_j$) is now used as a variable in MDA.

Table 9:1 presents each concepts' index ability to discriminate between the groups, only the reduced stocking rate index significantly discriminate ($P=0.005$) the 3 groups, ie Experts, Experienced and Inexperienced farmers.

Table 9.11 Reference Concept Discriminating Power within the Overall Attitude Index

Concept	Wilks' Lambda	F.	Significance
Reduced Stocking Rate	0.8707	5.6420	0.0052
Multiple Lamb Survival	0.9703	1.1640	0.3178
Ewe Body Condition	0.9691	1.2110	0.3036
Multiple Lamb Birthweight	0.9510	1.9530	0.1485
Multiple Lamb Growth Rate	0.9519	1.9210	0.1535
Later Lambing	0.9821	0.6919	0.5037
Controlled Set Stocking	0.9813	0.7255	0.4874
Summer Pasture Control	0.9281	0.6638	0.5178

The index data set contained significant discriminating power (Wilks Lambda = 0.688, $P = 0.0398$). The first discriminant function accounted for 62% of the total variance, in the data with the second function accounting for only 38%. (Refer Table 9:12).

Table 9:12 Canonical Discriminant Functions for Overall Attitude Index

Discriminant Function	Eigenvalue	Percent of Variance	Canonical Correlation	Wilks' Lambda	Signif. (P)
0	-	-	-	0.6876033	0.0398
1	0.25475	61.56	0.4505860	0.8627694	0.1522
2	0.15906	38.44	0.3704464	-	-
Standardized Canonical Discriminant Function Coefficients					
Concept			Function 1	Function 2	
2	Reduced Stocking Rate		0.8856	0.2757	
3	Multiple Lamb Survival		-0.4039	-0.2325	
5	Ewe Body Condition		1.0809	-0.7215	
6	Multiple Lamb Birthweight		-1.1299	1.2924	
7	Multiple Lamb Growth Rate		0.0370	0.6484	
8	Later Lambing		-0.2097	0.2507	
9	Set Stocking		-0.0884	-0.2215	
10	Summer Pasture Control		-0.0481	0.4969	

Index concepts associated with lamb birthweight (-1.13); ewe body condition (1.08) and reduced stocking rates (0.886) loaded most heavily onto the first discriminant function, which removed the significant discriminating power.

The second function had lamb birthweight, ewe body condition and lamb growth rate loading heavily.

Table 9:13 Mean Discriminant Scores for Overall Attitude Index resources for the Experienced and Inexperienced Groups.

Discriminant Function	Group	Mean	95 % Confidence Interval	P Signif.
One	Exp.	0.1717	-0.144 to 0.4874	0.0000
	Inexp.	0.3446	0.1068 to 0.5824	
	Expert	-0.8699	-1.6392 to -0.1006	
Two	Exp.	-0.5764	-1.2783 to 0.1254	0.0054
	Inexp.	0.3296	0.1952 to 0.4640	
	Expert	0.1037	-0.1956 to 0.4092	

The mean discriminant scores are presented in Table 9:13 along with their 95% confidence intervals and indicate that each group mean differs significantly on both discriminant functions, ($P = 0.0002$ and $P = 0.0037$).

Overall the groups account for only 21% and 14% of the variance in the discriminant functions, as determined by the squared canonical correlation values.

The ordering of the three groups along the one significant discriminant function is as would be predicted by the experiential learning theories with the Inexperienced farmers at one end of the continuum and Experts, the other. Figure 9:4 graphically represents the two discriminant functions, and indicate that reduced stocking rate and lamb survival correlate highly with this function - see also Table 9:14.

Table 9:14 Pooled within-groups Correlations between Canonical Discriminant Functions and Discriminating Variables. Variables are Ordered by the Function with Largest Correlation and the Magnitude of the Correlation.

Concept	Function 1	Function 2
Reduced Stocking Rate	0.75052*	0.17711
Multiple Lamb Survival	-0.34597*	0.03060
Ewe Body Condition	-0.23920*	-0.16853
Multiple Lamb Birthweight	-0.23162*	0.17013
Multiple Lamb Growth Rate	-0.09452	0.55093*
Later Lambing	-0.13618	0.54217*
Set Stocking	-0.02855	0.44615*
Summer Pasture Control	-0.13199	0.28622*

Experts have a strongly negatively overall attitude towards reduced stocking rate whilst both farmer groups held slight to moderately positive attitude towards the concepted reduced stocking rate.

Lamb survival was viewed as being very positive by the Experienced and Expert groups whilst the Inexperienced groups were the reverse, ie strongly negative.

All groups means were significantly different.

Index concepts reduced stocking rates and multiple lamb survival correlate highly with the significant discriminant function - refer Table 9:14, suggesting the cognitive differences between groups not only relates to the survival concept but also the stocking rate concept, if the peripheral beliefs are not taken into consideration.

Figure 9:4 Multiple Discriminant Analysis based upon the overall Attitude Index for the Expert, Experienced and Inexperienced groups.

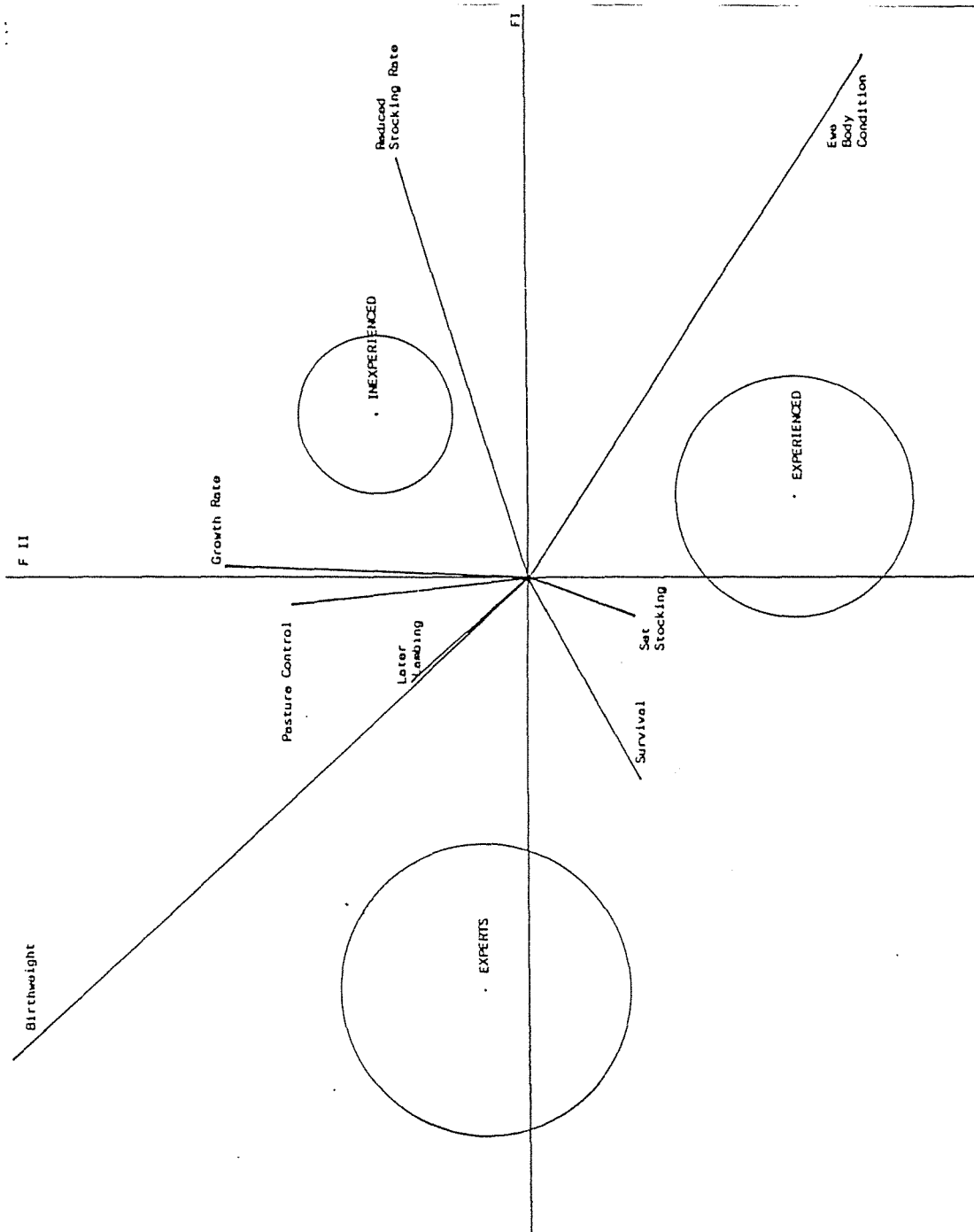

9.3.0 Summary

Chapter 9 presented the results of two analyses designed to highlight how the Expert, Experienced and Inexperienced groups are characterised by their principal beliefs, evaluative attitudes and index measures obtained from respondents.

Firstly the Procrustes rotation, a two way comparative technique offered as an integral part of the Galileo TM software was presented. An analysis of the comparison of the Experienced and Inexperienced groups was presented highlighting the different weightings applied to the concepts, multiple lamb survival, summer pasture control and lamb birthweight by the two groups, over all dimensions (10).

A software problem within the Procrustes rotation routine, in the way in which artificial dimensions were incorporated, meant that the presentation of all 10 dimensions for the Expert-Experienced and Expert-Inexperienced groups was not possible.

To overcome this the comparison of each pairing of groups was presented for the first 5 real dimensions in terms of the separation of each concept between each co-ordinate set and the degree of correlation between the respective position vectors.

The concepts on which the Experts and Experienced groups differed most were viz.

- Maintaining Ewe Body Condition
- Summer Pasture Control
- Multiple Lamb Survival

For the Inexperienced-Expert comparison the concepts of Reduced Stocking Rates, Ewe Body Condition and Multiple Lamb Birthweight were identified as being most different.

Multiple Discriminant Analysis was then applied to the measures of Principal beliefs, Evaluative attitudes obtained from the Galileo dataset, in an attempt to discern differences between the Expert, Experienced and Inexperienced groups collectively. In addition the belief and attitude measures were combined to form an overall attitude index which was utilised within the Multiple Discriminant Analysis.

The concepts that loaded heaviest upon the discriminant functions differed for the functions comprising principal beliefs, evaluative attitudes and the overall attitude index.

For the overall attitude index discriminant function the concepts loading heaviest and therefore contributing most to characterising the group were Maintaining Ewe Body Condition, Multiple Lamb Birthweights and Reduced Stocking Rates.

These concepts were the same as the concepts whose locations differed most within the common coordinate set for the Inexperienced and Expert groups, produced by the Procrustes rotation.

Similarly for the Experienced-Expert group Procrustes comparison, the same concepts were widely separated - although not necessarily having the largest separation.

Multiple Discriminant Analysis provided additional information in that as opposed to the two way comparison of the Procrustes rotations, a three way comparison is provided which offers researchers the ability to more fully understand the soft system component of management - from a static viewpoint, by highlighting the concepts that characterise one group from the others.

CHAPTER TEN : EXTENSION MESSAGES

10.0.0 INTRODUCTION

The Galileo (TM) program automatic message generator (AMG) subroutine results for the Expert and Farmer groups are presented. The messages that were derived from the Experienced and Inexperienced groups of farmers and the likely effect of different messages on each of the groups are discussed, as predicted by the linear aggregation theory proposed by Woelfel and Fink, (1980).

In the context of this study, the 'start' concept was the act, ie High Fecundity sheep management systems, with the 'target' being the 'self' concept. From an extension perspective with the objective of increasing the level of fecundity of sheep flocks, the desired result is one of reducing the distance separating the start and target concepts.

The Multiple Regression model was utilised to 'explain' the overall attitude measures, as such it should enable the impact of a respondent's belief and attitude measures upon their overall attitude to be predicted. For this reason the regression analysis was utilised to provide information on how respondents from each group are 'likely' to behave with respect to changes in their belief and attitude measures.

10.1.0 GALILEO EXTENSION 'MESSAGE' GENERATION

The objective is to combine concepts into a message such that the start - target (Act - Self, overall attitude) distance is minimised. The hypothesis being the smaller the overall attitude separation (ie stronger attitude) the more likely the adoption of the act.

A message is the combination of concepts in a statement that they are synonymous with the act:

ie Later Lambing is an essential input for a High Fecundity Production system.

This message is graphically portrayed in Figure 10:1.

Figure 10:1 Theoretical Representation of the Simple Message Later Lambing is Essential to High Fecundity Sheep Management.

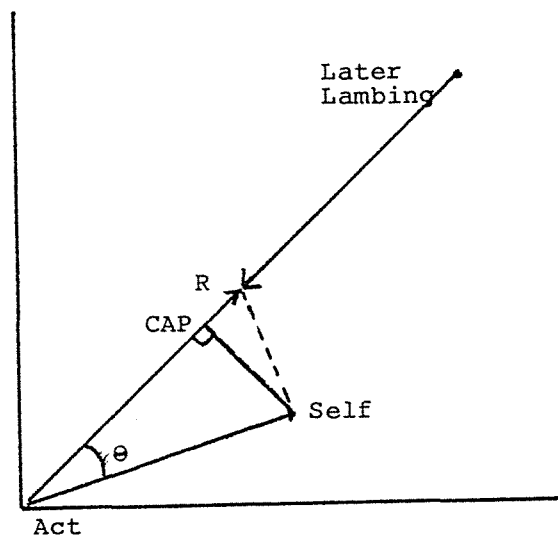

The act is used as the origin of the co-ordinate system. Prior to the message the overall attitude is represented by the Act - Self vector. The message is predicted to result in both the Act and Later Lambing to converge along the position vector for Later Lambing with the resultant position being 'R'. The predicted overall attitude is the segment R - Self. We note however that the optimal position along the position vector of Later Lambing is the C.A.P. (Closest Approaching Point) where the Self - C.A.P. segment is orthogonal with the resultant position vector. Theta (θ) represents the angle between the existing Act - Self vector and the predicted resultant vector.

Where more than one concept is incorporated into the message the message concepts and the act are assumed to average which becomes the resultant (R) position.

Table 10:1 presents the three 'best'¹ messages derived from the Galileo AMG for each of the analyses, with the relevant messages.

Table 10:1 Three Optimal Messages for the Expert, Farmer, Experienced and Inexperienced Groups as derived by the Galileo (TM) AMG.

Message Concepts	Theta θ	Act-T	Self-R	Self-Cap	Act-CAP	PCT (%)
(1) Experts (Act - Self = 11.32)						
3, 9	12.6	9.63	3.18	2.47	11.4	28.12
2, 6, 8,	962.6	16.60	5.03	10.05	5.20	44.41
2, 5, 7,	939.2	22.09	5.27	7.15	8.77	46.56
(2) Farmers (Act - Self = 36.26)						
3, 7, 8, 10	9.1	25.44	11.85	5.72	35.81	32.67
3, 8, 9	14.4	26.27	12.63	9.00	35.13	34.82
2, 3, 7, 9	10.2	24.64	12.79	6.44	35.69	35.26
(3) Experienced (Act - Self = 27.79)						
3, 7, 8, 10	7.1	28.21	3.49	3.43	27.58	12.56
2, 3, 5,	10.9	16.26	12.01	4.34	27.45	43.20
3, 6, 8, 10	7.5	15.41	12.67	3.65	27.55	39.93
(4) Inexperienced (Act - Self = 41.76)						
6, 7, 8, 10	10.7	29.53	13.87	7.75	41.03	33.21
3, 7, 8, 10	13.4	27.39	16.39	9.68	40.62	39.26
5, 8, 10	15.3	27.78	16.67	11.05	40.27	39.93

Concept Number	Concept Name
2	Reduced Stocking Rates
3	Multiple Lamb Survival
5	Maintaining Ewe Body Condition during Pregnancy
6	Increasing Multiple Lamb Birthweight
7	Multiple Lamb Growth Rates
8	Later Lambing/High Lactation Feeding
9	Controlled Spring Set Stocking
10	Summer Pasture Control

¹ 'Best' in that the result of the messages provide the smallest separation between the Target and Start concepts, with up to four concepts being combined into one message.

10.1.1 Expert Group

Within a management research context, especially in a cross sectional data base, the meaning of the message generated for the Expert group is of less use in that their inclusion was to represent the 'real' world knowledge of the act. The logic of attempting to adjust the representation of the 'real' world through extension messages is questionable, particularly considering the size of the overall attitude (11.32) for the Expert group in this study.

The optimal message for the Expert group was based on the concepts Multiple Lamb Survival and Controlled Spring Set Stocking and the act (start concept). This message is predicted to create a position vector (R - resultant) that is 12.6° (Theta) from the target vector (Act to Self vector).

The start concept is predicted to move 9.63 units (Act-R) resulting in an overall attitude (Self-R) of 3.18 units, equivalent to 28.12 percent of the existing overall attitude.

The closest that the message (Act-R) vector approaches the Self concept is 2.47 units (Self-CAP), ie the point that is orthogonal to the (Act-R) vector. The (Self-CAP) position predicted, requires the Act concept to move 11.04 units indicating that the CAP position is further along the Act-R vector than is predicted by the linear aggregation message theory used by the Galileo (TM) Program.

10.1.2 Farmer Group

The total farmer group was incorporated within the Galileo message analysis to determine whether one 'mass' message for all respondents, differed significantly in content to the message for the two experience subgroups. The initial overall index for the Farmer group was 36.26 units. The messages presented in Table 10:1 reduce this distance to 32.7 - 35.3 percent of 36.26 units.

The optimal message consisted of four reference concepts in addition to the act (Start concept). The concepts Multiple Lamb Survival, Multiple Lamb Growth Rates, Later Lambing/High Lactation Feeding and Summer Pasture Control were predicted to result in an overall attitude of 11.85 units; comparable with the Expert groups overall attitude (11.32 units) reported in the study. This would suggest that a very powerful extension campaign could be implemented to increase the level of high fecundity management used, by the respondents in this study.

The resultant vector for the above message was 9.1 degrees from the initial overall attitude vector. However, the large variance associated with the Summer Pasture Control concept indicates uncertainty by the respondents in their belief - attitude measures. This may suggest that it is 'more likely' to move, as opposed to those concepts with low variances, ie more fixed beliefs. Messages could therefore result in both concept movement and variance change. As the message generation is based around group means no account is taken of within group variance such that if there was no change to the variance as a result of a message, then the actual results in terms of self - act movement for individuals, are likely to be variable.

The second best message comprised three reference concepts with a predicted overall attitude of 12.63 units. The reference concepts to be included in this message are Multiple Lamb Survival, Later Lambing/High Lactation Feeding and Controlled Spring Set Stocking. The message is predicted to move the start concept 26.27 units at an angle of 14.4 degrees from the initial overall attitude.

The third message, consisting of the reference concepts Reduced Stocking Rates, Multiple Lamb Growth Rates, Multiple Lamb Survival, Later Lambing/High Lactation Feeding and Controlled Spring Set Stocking gave a predicted overall attitude of 12.79 units.

Of the three messages generated, the third requires the least motion of the start concept, such that the resultant position is more likely to be achieved. This is likely due to messages

working over time and not instantaneously such that the message impact could lessen over time. In case of a large adjustment to the cognitive structure, some reinforcement may be necessary to actually achieve the predicted result.

10.1.3 Experienced Farmers

The predicted optimal message for the Experienced farmer group was similar to the optimal message for the Total Farmer group. For the Experienced group this message is particularly successful with only 12.56 percent (ie 3.49 units) of the overall attitude distance (27.79 units) remaining after the predicted motion occurs.

An additional advantage of this message is that the C.A.P. position is between the start and resultant position for the act. If the respondents responded in a lesser degree than is predicted a closer position may result, (ie overall attitude (TG-CAP) of 3.43 units).

The two alternate messages presented, comprise of four reference concepts ie:

Message 2 - Reduced Stocking Rates

- Multiple Lamb Survival
- Maintaining Ewe Body Condition During Pregnancy
- Summer Pasture Control

Message 3 - Multiple Lamb Survival

- Multiple Lamb Birthweight
- Later Lambing/High Lactation Feeding
- Summer Pasture Control

Both of the alternate messages required less motion (16.3 and 15.4 units respectively) than the optimal messages and result in a relatively strong overall attitude (12.01 and 12.67 units respectively). The extension problem would be to weight the benefit of achieving a very strong overall attitude (as for the optimal message) from a moderate distance moved, against a

strong overall attitude for smaller distance. Galileo theory assumes that the distance to move is independent of the likely result.

10.1.4 Inexperienced Farmers

All three messages presented (Table 10:1) resulted in relatively similar overall attitudes, with 33.2 to 33.9 percent of the initial overall distance remaining.

The optimal message comprises of reference concepts Multiple Lamb Birthweight, Multiple Lamb Growth, Later Lambing/High Lactation Feeding and Summer Pasture Control and is predicted to move the act 29.5 units, resulting in an overall attitude of 13.87 units. The closest approaching point (CAP) requires 41.03 units of motion to achieve an overall attitude of 7.75 units.

The optimal message is very similar to the next best except that the Multiple Lamb Birthweight concept is replaced by the Multiple Lamb Survival concept. In effect the second message replaces an input concept with the associated output concept suggesting that in practice the two messages are strongly associated.

The second message for the Inexperienced group is the optimal message for both the Total Farmer sample and Experienced Farmer groups.

10.2.0 SUMMARY - DISCUSSION OF GALILEO MESSAGES

From an extension viewpoint the failure to differentiate between groups would have little impact, providing the message related the act to the concepts, viz:

- Multiple Lamb Survival
- Multiple Lamb Growth
- Later Lambing/High Lactation Feeding
- Summer Pasture Control

For the Inexperienced farmers there is a small advantage in using the Multiple Lamb Birthweight concept rather than the Multiple Lamb Survival concept. Given the management context of this study the use of input concepts in messages may achieve a greater implementation and achievement of the act as opposed to the output concepts which will create an awareness towards the structure of the management problem. Further research is needed to determine whether an awareness message is necessary prior to a management input message to achieve a marked increase in adoption.

Several alternative message systems have been proposed by researchers which, if proven, would alter the linear force theories of Galileo theory.

Two such theories are the oscillating spring force theory of Kaplowitz and Fink (1982) who claim that a message creates instability in concept relativities, resulting in an oscillation motion, which eventually comes to rest at a new position. Alternatively are the threshold theories in which concepts require a certain input of energy (information) prior to their movement, with each concept threshold being independent of other concepts. (Cary, pers comm). The delivery of the above messages could also be tested using a time series data base in which the cognitive structure of groups of respondents through time could be measured and compared using the Procrustes Rotation system available in the Galileo TM program.

10.3.0 MULTIPLE REGRESSION MODEL

Multiple regression was used to develop a set of standardised Beta weights to apply to the independent variables (in this case the overall attitude index ' $a_j b_i$ ' comprising the product of an individual's principle belief and evaluative attitude with respect to concept i), to improve the predictability of the overall attitude index.

The multiple regression model can be defined as:

If the i th principle belief is represented by b_i (the distance between the act and the i th concept) and the i th evaluative attitude is represented by a_i (the distance between self and the i th concept), and A is the overall attitude (represented by the Self - Act distance), then the multiple regression model is

$$A = \beta_0 + \beta_1 (a_1 b_1) + \dots + \beta_n x_n + e.$$

The regression model utilised pooled the variance across all individuals.

The set of Beta weights derived from the regression analysis is presented in Table 10:2. The only concept variable which displayed a significant Beta weight was the lamb survival concept, (sig F = 0.003).

Table 10:2 Beta Weights for the Concepts with Variance Pooled Across Groups

Concept	Beta	Sig F
Summer Pasture Control	-0.11605	0.2749
Ewe Body Condition	-0.38526	0.2641
Later Lambing Date	0.13390	0.1990
Lamb Growth Rate	0.12507	0.2329
Reduced Stocking Rate	-0.13760	0.1789
Controlled Set Stocking	-0.11126	0.3550
Lamb Survival	0.47590	0.003
Lamb Birthweight	0.35218	0.3083
Constant Value	23.49	0.0000

Although the regression equation was highly significant (sig F = 0.005), it was not a very good predictor of the overall attitude measures reported by the respondents, (ie $R^2 = 0.319$).

The regression sum of squares equalled 28388.9 (8 d.f.), whilst the residual sum of squares equalled 60493 (69 d.f.).

The positive regression coefficients associated with the concepts Lamb Survival, Lamb Birthweight, Later Lambing and Lamb Growth Rates mean that individuals with a strong overall attitude index (smaller) relative to these concepts, have a stronger overall attitude towards high fecundity sheep production systems.

The concepts of Summer Pasture Control, Ewe Body Condition, Reduced Stocking Rate and Set Stocking have negative coefficients such that the weaker the overall attitude index (ie larger number) the stronger the overall attitude towards high fecundity sheep production systems.

Therefore if the objective was one of reducing the overall attitude towards the act, intervention that reduced the index associated with concepts with positive regression coefficients should be employed. This could be achieved by strengthening either the principal belief of the evaluative attitude towards the specific concept.

Alternatively those concepts with negative regression coefficients should be increased ie the principal beliefs and/or evaluative attitudes weakened.

10.4.0 SUMMARY

In chapter 10, the analyses designed to predict change in the overall attitude of groups of respondents based upon both Galileo methodology and multiple regression were presented. It does not research or discuss the extension implications or techniques that would enable the objective of changing individuals' overall attitudes towards some given act.

Instead the 'best bet' messages that arose from this study and the likely results as predicted are discussed. Galileo

methodology identified the concepts Multiple Lamb Birthweights, Multiple Lamb Growth Rates, Controlled Set Stocking and Summer Pasture Control to be optimal in achieving the objective of minimising the Act - self distance by their inclusion in a message involving the act.

Multiple regression presented a set of Beta weights associated with each concept such that a change in a concepts index measure would result in a predicted change in the overall attitude. The concepts with greatest ability (largest Beta weight) to change the predicted overall attitude were Lamb Survival, Lamb Birthweight and Ewe Body Condition.

Further research into the dynamics of cognitive change is necessary for the evaluation of alternative extension approaches, and the techniques presented in this chapter provide an opportunity to do so.

CHAPTER ELEVEN : CONCLUSIONS

11.0.0 INTRODUCTION

The primary objective of this study was to evaluate the use of the Galileo measurement system to objectively and quantitatively represent the components of behaviour held by a group of producers with respect to the act - HIGH FECUNDITY SHEEP MANAGEMENT SYSTEMS.

Behavioural components were identified as being beliefs and attitudes by Fishbein and Ajzen (1979) in their model of reasoned action. Beliefs being the relationships between the act and associated concepts while attitudes represent the relationships between the 'self' concept and all other concepts.

A management version of the Fishbein and Ajzen model was presented in an attempt to incorporate the important time dimension that exists within management. This was achieved by differentiating between input and output concepts. The Galileo model of behaviour adds to the management model by incorporating the relationships between the concepts themselves in addition to the beliefs and attitudes already defined. These relationships were defined as Peripheral beliefs as opposed to the Principal beliefs defined in the Fishbein and Ajzen model.

Checkland (1979) and others have labelled the human learning/knowledge component of the management process as being the soft component, as opposed to the hard component which incorporates the underlying technical, biological and financial relationships. Loftus and Cary (1980) placed the hard component within the soft component in their learning framework of management.

People are predicted to gain more knowledge, ie learn, as a high proportion of their belief relationships align with the 'real world' position. The representation of the belief and attitude relationships at one point in time represents a static soft systems model whereas the inclusion of a time dimension would provide insight into the process of learning.

This study was designed to move on from the qualitative work on soft systems - Squires and Hughes 1973; Walker 1984, into a more quantitative, objective representation, ie moving from the art to science of farm management, as noted by Nix (1979).

The move into the 'science' of soft systems research was achieved by the use of the 'Galileo' measurement system, with further analyses based upon Multiple Discriminant Analysis and Multiple Regression. This study primarily utilises a static representation of belief and attitude relationships, but attempted to incorporate part of the time dimension by having a cross sectional sample with respondents having varying levels of experience of the act. This design was similar to that used by Musser et al (1986).

11.1.0 GALILEO MODEL

11.1.1 Measurement Task

Three separate aspects of the measurement task were identified.

(A) The Identification of Reference Concepts

The identification of reference concepts via the passive interview technique recommended by Woelfel et al (1979) proved to be inadequate for this cross sectional study. This was due to respondents from different cross sections being asked to complete different tasks. Experienced managers discussed what they in effect did, whilst Inexperienced Managers attempted to discuss what might have been, which the majority had considerable difficulty with. To overcome this problem the slightly more structured interactive interview system (Walker 1984) was utilised with considerably more success.

Recommendation Number One:

That a combination of both passive and interactive interview techniques be utilised in deriving reference concept lists.

The context within which the act was discussed during the elicitation interviews varied between respondents, with some discussing the act in terms of the physical constraints of their own properties, whilst others discussed the act in a more open context.

Recommendation Number Two:

That the act be placed within a specified context prior to concept elicitation interviews.

(B) Measurement System

The means used to measure the belief and attitude relationships is the second component of the measurement problem. The ability to measure on a consistent basis on a within and across study basis when a time series database is to be collected becomes critical. For this reason objective, quantitative measures are more desirable.

This study utilised a direct measurement system where an open ended ratio scale was used to measure distances between reference concepts, relative to a given standard separation, ie the criterion distance.

Respondents reported considerable difficulty in this component of the measurement task.

The open ended nature of the scale gave variable distances when the two concepts were viewed as dissimilar whereas those concepts considered to be relatively similar on average displayed less variance. In discussion with some respondents it would seem that dissimilarity as defined relative to the criterion concepts was not interpreted consistently by all respondents, ie in some cases respondents used numbers greater than 100 while others viewed 100 as the boundary to the scale.

Recommendation Three:

That the possibility of reversing the scale be considered, in that zero equates to dissimilar and 100 units (in this study) equates to total similarity. This recommendation would also

overcome the need to develop a criterion pair that had a consistent meaning throughout the sample.

(C) Presentation of the Measurement Task to Respondents.

The ordering of pairs within the comparison task to minimise any respondent burden requires further research. Firstly, ordering of concepts within a pairing would appear to have an influence upon the resultant measure. If the pairing is on an input-output basis respondents scale on the basis of the association of the outcome from the input, but if the pairing is reversed some variation results. Some respondents would appear to scale on the basis that given this outcome what is the effect upon the inputs in say the next season.

Recommendation Four:

That further research be instigated to examine the effects of the ordering of concepts within a pairing.

Woelfel and Fink (1980) claim that respondent burden is associated with the length of the task and also the difficulty of the task. Certain relationships would appear to be critical in soft systems research, namely the overall attitude, evaluative attitudes and the principal beliefs. Due to the difficulty in scaling the self concept, the attitude measures need to be completed early in the measurement task.

With respect of peripheral beliefs it would appear logical that input-outcome associations should appear before the input-input and outcome-outcome associations.

Recommendation Five:

That the problems associated with respondent burden and the influence of concept pairing types needs further research. This would appear to be especially so in this study where the Expert group tended to emphasise outcome concepts, ie Multiple Lamb Survival, whilst the Farmer groups emphasised the inputs necessary to achieve the outcomes, ie Higher Birthweights of Multiple Lambs.

One possibility for minimising respondent burden may be to scale the necessary outcomes to the act and self separately from scaling the inputs required to achieve these outcomes.

11.2.0 BELIEF-ATTITUDE RELATIONSHIPS

The Galileo measurement system utilise metric multidimensional scaling to represent the belief and attitude measures obtained from the paired comparison measures. The individual measures were averaged within cross sectional groups to provide a group average matrix of belief and attitude measures.

The overall attitude measures reported in this study supported the Cognitive Experiential Learning theories in that the Expert and Farmer groups reported overall attitudes of 11.3 and 36.3 units respectively. Within the Farmer group those farmers with Experience (21.8 units) reported a stronger overall attitude than the Inexperienced group (41.8 units).

Both Farmer groups required 6 real dimensions and 4 imaginary dimensions to array the ten reference concepts, whilst the Expert group required 5 real and 5 imaginary dimensions.

The trace of the spatial representations for the Experts, Experienced and Inexperienced groups was 12701, 14697, 7893 respectively. According to Stoyanoff and Fink (1980) the higher trace values suggest that the Experts and Experienced farmers had a greater capability to discriminate amongst reference concepts. This could be assisted by the Experts and Experienced groups having greater amounts of information/knowledge which, when associated with the fine discrimination, would increase the trace size. The author hypothesised that the trace associated with a group of individuals is likely to be very small for those whom have little or no information with respect to the act. The trace is predicted to increase as information is gained and 'tried', and that as the real system is learnt, ie the belief and attitude relationships fit the outcomes experienced, the trace is likely to decrease again.

Both Farmer groups reported lower warp factors than the Expert group which suggests that they have a lower level of inconsistency in their cognitive relationships. A somewhat different interpretation would be that the Expert group has more information about the act and as such it is harder to integrate. The concept of inconsistency declining over time in a management context may be difficult to establish, due to the innate variability of the biological production system that operates.

The results indicate that the cognitive structure of the Expert and Inexperience groups were more closely aligned than the Expert-Experienced group relationship.

Given that the Experts represent the 'real' world situation, the Experienced group was hypothesised to have a cognitive structure most similar to the Experts.

The results in this study would suggest that this is not so, such that it could now be hypothesised that all farmers have similar beliefs and attitudes ie that 'real' world relationships are known by all. The reason for nonadoption being the strength of the overall attitude held with respect to the act.

As the process of learning takes place, those respondents' who have experiences associated with the act will change/adjust (or challenge) their existing belief/attitude relationships. This may result in changed beliefs and or attitudes or increasing uncertainty (ie increased variance) with respect to these relationships. Within a Galileo Methodology sense the trace of the belief and attitude interconcept separation matrix is likely to increase. As the new or revised relationships are reinforced, adjusted or discarded the trace is likely to decline; and the overall attitude towards the act strengthened.

This situation provides some insight into how extension practitioners should manage clients whom are changing, especially innovators. It is conceivable that the process of learning could result in the wrong relationships being formed (increasing the Trace). The response of the Manager may be to continue in an effort to learn the 'true' or 'real' relationships.

Alternatively the wrong relationships could be accepted creating an attitude that the 'new' system did not meet my expectations which were subsequently changed, stemming from this may be a negative attitude towards the extension practitioner. To minimise the risk of this a management information system needs to be put in place and interpreted in a manner that would maximise the opportunity to learn the 'real' relationships. This system will require a close liaison between the extensionist and his clients that undergo significant management changes. This process of learning would relate more closely to the Oscillating Spring theories of Kaplowitz and Fink, (1982), where the initial movement is past the point of equilibrium and then overtime the changing relationships oscillate before establishing a new equilibrium position.

The reference concepts most closely associated with the act for all three groups involved the Later Lambing Concept. In addition the Expert group emphasised the Lamb Survival and Lamb Growth Rate concepts. The Experienced group on the other hand emphasised the Ewe Body Condition and Controlled Set Stocking concepts - both of which are inputs to achieve survival and growth rates. The Inexperienced group emphasised the concepts Ewe Body Condition and Lamb Birthweights which are inputs into Lamb Survival, and the concept of Lamb Growth Rates.

Evaluative attitudes for the Expert and Experienced farmers contained strong positive attitudes towards the concepts of Later Lambing and Lamb Survival. In addition, the Expert group emphasised the concepts of Lamb Birthweights and Summer Pasture Control whilst the Experienced farmers emphasised the Controlled Set Stocking concept.

The Inexperienced farmers closely associated themselves with Lamb Growth Rate and Lamb Survival concepts, emphasising input concepts for achieving Lamb Survival.

11.2.1 Between Group Comparisons

The Galileo model enables a two way comparison between groups via the Procrustes rotation routine.

One problem which arose with this routine is that within a cross sectional research design, when two groups that required differing numbers of real and imaginary dimensions to represent the belief and attitude distances were being compared, the sub-routine wrongfully calculated magnitude and scalar product values. This was due to the insertion of artificial dimensions at the point of lowest variance, which were in some instances included in the calculation and in some instances excluded.

For the comparison between the Experienced and Inexperienced groups this problem did not arise as both groups required similar numbers of real and imaginary dimensions. This comparison highlighted the similarity of the Later Lambing concept for both groups. The concept most different in the two groups was the Multiple Lamb Survival concept, reflecting the greater emphasis placed upon the survival concept by the Experienced group.

To overcome the above problem all three comparisons were presented for the first 5 real dimensions only.

The Procrustes rotation enabled a two way comparison of groups such that those concepts considered most different and similar (in terms of belief and attitude measures) were identified helping to characterise the groups within the sample.

Multiple Discriminant Analysis was used to further characterise the groups, but with the advantages of comparing all three groups simultaneously but within a low dimensionality.

The principal belief and evaluative attitude measures used in the Galileo analysis were then analysed using Multiple Discriminant Analysis to discriminate the three groups simultaneously on the basis of each individual's discriminant function score.

(A) Principal Beliefs

Four reference concepts provided significant discrimination power in separating the three groups. The concepts of Reduced Stocking Rates, Multiple Lamb Survival and Multiple Lamb Growth Rate and Maintenance of Ewe Body Condition. The first discriminant

function ordered the groups as predicted by experiential learning theories.

(B) Evaluative Attitudes

Only three reference concepts - Reduced Stocking Rates and Multiple Lamb Survival and Multiple Lamb Growth Rates provided significant discriminating power between the three groups based on the evaluative attitude measures. The groups were ranked on the multiple discriminant function the same as for the Galileo analysis.

(C) Overall Attitude Index

An index comprising the individual concept components of the overall attitude index as presented by Fishbein and Ajzen (1979) was constructed and used as the independent variables for Multiple Discriminant Analysis. Only the Reduced Stocking Rate concept displayed significant discriminating power. The only significant discriminant function ordered the groups as was predicted by the learning theories. This is tempered somewhat by the fact that the Experienced group was closely associated with the Inexperienced group with a large gap to the Expert group. The index associated with the concepts Maintaining Ewe Body Condition, Multiple Lamb Birthweight and Reduced Stocking Rates contributed most to discriminating between groups. The same concepts displayed large separations within the two way Procrustes rotation comparisons, especially for the Expert - Inexperienced groups, indicating a degree of alignment between the two descriptive analyses.

It would appear that the inclusion of Peripheral beliefs in the Galileo model removed the significance of the Reduced Stocking Rate concept obtained within the Multiple Discriminant Analyses, for the comparisons between the Expert - Experienced and Experienced - Inexperienced groups.

11.3.0 FARM MANAGEMENT EXTENSION

Farquhar defined extension as "... a service which assists farm people through educational procedures...". (Farquhar, 1962).

Relative to farm management extension, this study offered two objectives. Firstly, knowing where the respondents are, ie what is the present state of knowledge of the respondents. This has been labelled as empathy and commonality and is the underlying principal within Emery and Oesar's (1958) 'successful communication model' and Woog's (1982) Model of Personal Interaction.

Given the researcher has knowledge of the cognitive structure of an individual, the belief and/or attitude relationships can be targeted to meet the extension objective.

The Galileo (TM) program includes an automatic message generator where reference concepts are linked in messages (up to four concepts per message) and the optimal message selected. The selection criteria being the message that minimises the overall attitude distance, where each message is predicted to result in the motion according to a linear aggregation theory. (Woelfel and Fink, 1980).

Within this study each farmer group was analysed via the automatic message generator. However, very little difference in optimal messages resulted. The optimal message for all groups requires the concepts Multiple Lamb Survival, Multiple Lamb Growth, Later Lambing and Summer Pasture Control to be combined with the act. For the Inexperienced group the Multiple Lamb Survival concept should be replaced by Multiple Lamb Birthweight, the latter being an input to achieve the former.

Multiple regression analysis where the independent variables were the Fishbein and Ajzen index for each concept and the dependent variable is the overall attitude also provides information on the likely impact of changing beliefs and attitudes. The concepts of Lamb Survival, Lamb Birthweight and Ewe Body Condition have the largest Beta weights and hence any change to the index associated

with these concepts would result in the biggest change to the predicted overall attitude. The concepts identified by Multiple Regression in this study, to impact on the overall attitude to high fecundity were in close alignment with those generated by the Galileo AMG and those that correlated heavily with significant discriminant functions.

The regression analysis although not robust in predicting the Overall attitude as scaled by respondents, does enable beliefs and attitudes to be targeted in a positive or negative manner, to achieve the required change in Overall attitude.

To the extent in this study that the cognitive structures of the Expert and Inexperienced group are more similar than the Expert and Experienced group, yet the overall attitude measures for the Expert and Experience group are more similar, difficulties in the application of the Fishbein and Ajzen model exist.

Fishbein and Ajzens' model predicts that individuals with similar cognitive structures will have similar overall attitudes, this does not agree with the results presented.

This may reflect the exclusion of the subjective norm in the study, resulting in a distorted representation of the cognitive structures presented. Alternatively it may be that the Fishbein and Ajzen model is not 'complete' such that additional variables are necessary or that the attitudes and beliefs are aggregated in a different manner.

Within the Galileo model the premise is still that the overall attitude is some function of an individuals' cognitive structure. The problem is - to a degree, overcome in that firstly the Procrustes analysis rotates the overall attitude to a position of best 'fit' and then rotates all concepts using the same rotation, highlighting differences between the two cognitive structures.

The AMG provides an analysis of the impact of changing components of the cognitive structure in order to strengthen the overall attitude. To the extent that the reference concepts widely

separated in the Procrustes rotation, involving the Expert group, differ from those within the messages generated. Galileo would appear to indirectly incorporate the notion that a different cognitive structure could be associated with similar overall attitudes.

Further research should be carried out to investigate the influence of the messages that are generated by the Galileo (TM) AMG sub-routine. Such research requires time series data, a problem identified by Musser et al (1986) also. The Galileo program does appear to offer the opportunity to carry out time series data analysis which would enable intervention strategies and planned extension programmes to be evaluated.

Galileo measurement system and the supporting multivariate analyses, offers Farm Management researchers the opportunity to objectively measure the cognitive relationships of farmers, in an effort to provide greater insight into soft system/management systems.

APPENDIX 1.0

YOUNG AND HOUSEHOLDER THEOREMS

Consider an n -dimensional matrix of interpoint distances (separations), where d_{ij} is the distance between points i and j . If we select point i as the origin (reference point) then let B_i denote the $(n-1)$ dimensional matrix of scalar products with typical element:

$$b_{jk} = \frac{1}{2} (d_{ij}^2 + d_{ik}^2 - d_{jk}^2). \text{ The matrix } B_i \text{ is symmetrical.}$$

Case 1: B_i is positive semidefinite.

The characteristic roots of B_i are positive or zero, and the rank of B_i equals the number of positive characteristic roots (taking into account the multiplicity of any positive characteristic root).

The rank of a positive definite scalar products matrix B_i equals the dimensionality of real Euclidean space necessary to account for the mutual interpoint distances with origin at point i .

Let $r \leq (n-1)$ be the rank of B_i . Then B_i can be factored to obtain a $(n-1) \times r$ orthogonal matrix A , where $B_i = AA'$. The row elements of A are the projections of the points onto r orthogonal axes in real Euclidean space, with point i at the origin.

The columns of A are the characteristic vectors associated with each positive characteristic root of B_i (there are orthogonal characteristic vectors corresponding to the multiplicity of any characteristic root). Furthermore, if we denote the j th column of A by a_j , we can find values for the elements of a_j such that $a_j' a_j = \lambda_j$, where λ_j is the j th positive characteristic root of B_i .

Also, the trace of B_i equals the sum of the characteristic roots of B_i (again, taking account of the multiplicity of any characteristic root).

Since the diagonal elements of B_i are the squared distances between point i (the origin) and each of the other $(n-1)$ points, we can describe $\text{Tr}(B_i)$ as the interpoint variance from the origin. We can therefore order the columns of A (coordinates of the points in one dimension) so that successive dimensions maximise the reduction in the remaining interpoint variance from

the origin. Since $\text{Tr}(B_i) = \sum_j \lambda_j^2$, this is accomplished by

setting the first column of A as the characteristic vector associated with the largest characteristic root of B_i ; and the second column of A as the characteristic vector associated with the second largest characteristic root, etc.

By scaling the elements of a_j such that $a_j' a_j = \lambda_j$, the resulting point coordinates maintain the original interpoint variance from the origin.

Case 2: B_i is indefinite

In this case some of the characteristic roots of B_i are positive, and some negative. (Some may also be zero). The rank of B_i equals the number of non-zero characteristic roots (again taking into account the multiplicity of any root). In this case, negative characteristic roots correspond to imaginary space, i.e. the points cannot be represented exactly real Euclidean space.

The properties discussed above hold, except that for a negative characteristic root, the corresponding characteristic vector is scaled so that:

$$-(a_j' a) = \lambda_j$$

Although $\text{Tr}(B_i) = \sum_j^r \lambda_j$,

the existence of negative characteristic roots makes interpretation of the ratio: $\lambda_j / \text{Tr}(B_i)$ somewhat difficult in terms of reduction in interpoint variance from the origin due to the j th dimension. Where a real spatial representation of the points corresponding to the original interpoint distances is required, the best available representation in p dimensions is given by the characteristic vectors associated with the p largest positive characteristic roots of B_i .

-----//-----

Characteristic equation of B : $|A - \lambda I| = 0$

Characteristic roots of B are values for λ that solve the characteristic equation.

If b is $(n \times n)$ then the characteristic equation is a n th order polynomial in λ , with up to n real roots.

The j th characteristic vector of B solves:

$$[A - \lambda_j I]a_j = 0$$

Let \bar{a}_j be a characteristic vector of B corresponding to j , then

$$a_j = [\lambda_j (\bar{a}_j' \bar{a}_j)^{-1}]^{1/2} \bar{a}_j$$

is also a characteristic vector of B , and $a_j' a_j = \lambda_j$

Appendix 1.1 Eigenvalues (eigenroots, characteristic roots) etc.

The eigenvalues of a square matrix B^* ($n \times n$) are the roots of the characteristic polynomial equation: $|B^* - \lambda I| = 0$.

The values for λ (roots) that solve the characteristic equation may be positive, negative or zero, and the same value for λ may occur a number of times (multiplicity).

Associated with each value of λ_j is a characteristic vector (eigen-vector) solving:

$$[B^* - \lambda_j I]x_j = 0$$

where $x_j \neq 0$.

Since $|B^* - \lambda_j I| = 0$ the non-trivial solution vector elements of x_j are determined only up to a scale factor. The rank of B^* is given by the number of non-zero eigenvalues (taking the multiplicity of eigenvalues into account).

The scalar products matrix B^* is symmetrical with origin at the centroid of n points.

If B^* has no complex numbers as elements (i.e. all elements are real), there are no complex eigenvalues.

The matrix B^* can be factored to obtain a ($n \times r$) matrix A , such that:

$$B^* = AA'$$

The columns of A are given by the set of characteristic vectors of B^* corresponding to the set of r non zero eigenvalues of B^* . The characteristic vectors of B^* are mutually orthogonal, and may be scaled so that the sum of the squared elements of an eigenvector equals the corresponding eigenvalues, (times minus one for a negative eigenvalue).

The sum of the eigenvalues of B^* equals the trace of B^* (sum of the diagonal elements).

The coordinates of the points whose interpoint distances were used to derive the scalar products matrix B^* are given by the row elements of A . Since the diagonal elements of B^* are the squared distances of each point from the origin (centroid of the points), the variance of the points is given by the Trace of B^* . The original interpoint distances from the origin can be maintained by scaling the columns of A (dimensions of the space in which the n points are located) so that for the j th column: $x_j'x_j = \lambda_j$.

Positive eigenvalues give eigenvectors in real Euclidean space, while negative eigenvalues give eigenvectors in imaginary Euclidean space.

Warp Factor

With negative eigenvalues we can have: $\sum_j \lambda_j^{(+)} > \text{Tr}B^*$,

since $\sum_j \lambda_j^{(+)} + \sum_k \lambda_k^{(-)} = \text{Tr}B^*$.

The Warp factor = $\frac{\sum_j \lambda_j^{(+)}}{\text{Tr}B^*}$

= 1 if the n points can be exactly represented in real Euclidean r -space. Thus the warp factor provides a 'summary measure' of the extent to which the Euclidean space is warped (requires the inclusion of imaginary Euclidean space to represent the point coordinates).

With negative eigenvalues, the ratio

$$\frac{\lambda_j}{\text{Tr}B^*}$$

has little meaning as the proportion of the variance in B^* explained by the j th dimension. Accordingly, the ratios (or percentages):

$$\frac{\lambda_j^{(+)}}{\sum \lambda_j^{(+)}} \text{ and } \frac{\lambda_k^{(-)}}{\sum \lambda_k^{(-)}}$$

are utilised to express the percentage of variation in real Euclidean space (imaginary Euclidean space) explained by the j th real dimension (k th imaginary dimension) respectively.

APPENDIX 2.0

SCHEMA OF HIGH FECUNDITY MANAGEMENT CONCEPTS

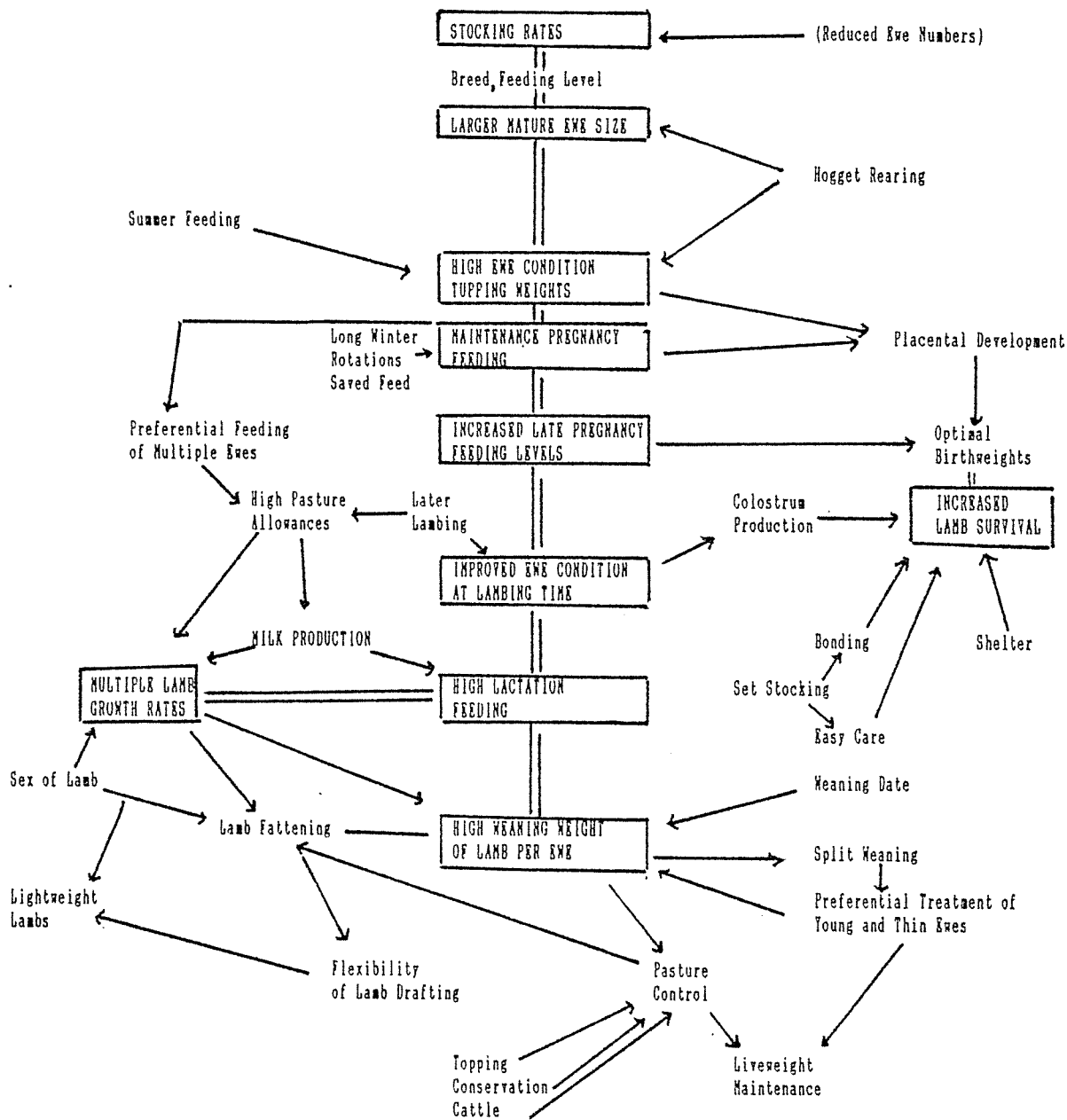

APPENDIX 3.0

PILOT — PAIR COMPARISON INSTRUCTIONS

I would like you to give me your opinion about some ideas related to successful management aimed at maximising the weight of lambs weaned per ewe in flocks with a lambing potential of at least 140% lamb drop. You can assist by comparing these ideas to each other to tell how different or how far apart they are. For example, I might ask, "How different are long winter rotations and set stocking at lambing?" I would like you to answer with a number. If the two ideas are very different, you would use a large number. If they are very similar, you would use a small number. If they are identical use a zero.

To assist you judge how large the differences are, we'll say that the amount of difference between long winter rotations and set stocking at lambing is 100 units. Please keep this difference in mind when comparing the other pairs of words. If the two words are further apart than long winter and set stocking at lambing, use a number larger than 100 units, ie if they are twice as far apart, use 200 and so on. There are no wrong answers, I only want your opinion which will be kept confidential.

Remember: The difference between long winter rotations and set stocking at lambing is 100 units.

Appendix 4:0 Study Pair Comparison Instructions and Reference
Concept Definitions

C/- Ag. Economics Dept
Massey University
PALMERSTON NORTH

Dear _____

Please find enclosed the final questionnaire of my research into farmers' beliefs and attitudes towards practices associated with successful high fecundity management. The purpose of this research is to identify what practices farmers see as being important for successful management of high fecundity flocks. Once the common practices have been found they are paired off with each other and farmers are asked to place a weighting on each pairing enabling a strength of belief to be obtained.

The following questionnaire is in two halves, the first part requires you to indicate what sources of information you utilise and other introductory information. The second part is designed to obtain the strengths of farmers' beliefs by asking you to place a number on each pairing - as is explained in the instructions. The overall questionnaire should take no longer than 40 - 45 minutes to complete with part two taking no longer than 30 - 35 minutes, as I am interested in an instantaneous but thoughtful reply to each pair. Please don't spend a long time tossing over ideas for each pairing as each answer should take approximately 15 seconds.

The purpose of this research is twofold in which:

- 1 A methodology aimed at utilising farmers' experienced in the development of managerial systems is being evaluated.

- 2 Investigate high fecundity management practices, incorporating theoretical and practical experiences. The overall aim being to increase the relevance of research to you the farmer by understanding your views and using them in the development of overall systems.

I would appreciate a prompt reply by 10 September and would thank you for your assistance and co-operation with this research - the results of which will be reported back to you as soon as possible. Thank you.

Yours sincerely

(Lindsay Saunders)

Telephone: Palmerston North 63-179 evenings

PART TWO : INSTRUCTIONS

I would like you to give me your opinion about some practices relating to successful management practices aimed at maximising the weight of lamb weaned per ewe in flocks with a lambing potential of at least 140% lamb drop.

I am interested in exploring how closely or how far apart you associate in your mind a number of practices that may or may not contribute to the successful management of high lamb drop sheep flocks. You will see that to explore your opinions in the attached questionnaire, the single work 'self' is included while the practices I am interested in are covered by words/phrases like, for example, Reduced Stocking Rates.

For my purposes I need to have the closeness or distance between practices in figures and to achieve this I will be asking you to put a relative figure on each pairing. For example:

How close or far apart in your mind do you associate Mercedes Benz cars and comfortable motoring?

To help you put a figure on this I would say that the distance between V.W's and comfortable driving is 100 units apart. In your mind Mercedes Benz and comfortable driving may be closely associated so you would answer with a small number - say 10 units apart. If, however, in your mind Mercedes Benz cars are the ultimate in comfort and there would be no distance between them you would answer with a zero. You may then be asked how close or far apart are comfortable driving and a horse and buggy?

In your mind you may see either a very weak association or no association. If this is so you would answer with a very large number - say 3500 units apart.

For this research I might ask you "How close or far apart are 'All Sheep Farming and All Cash Cropping?" To help you with the distances, I'll ask you to say that in your mind 'All Sheep Farming and All Cash Cropping' are 100 units apart. Please keep the difference in your mind when comparing the other pairs of words. If the two words are further apart than 'All Sheep

Farming and All Cash Cropping' use a number larger than 100 units - ie if they are very much larger use a number very much larger than 100 units. If the words are closer together in your mind, then use a number smaller than 100 units. If they are identical, please use a zero.

There are definately no wrong answers - I only want your opinions and beliefs which will remain confidential.

Can you please keep in your mind that the distance between 'All Sheep Farming and All Cash Cropping' is 100 units apart.

Appendix 5:0 Co-ordinate sets for the Cognitive Structures obtained from the Expert, Farmer, Experienced and Inexperienced Groups

(A) EXPERT GROUP : DIMENSION

	1	2	3	4	5	6	7	8	9	10
1	5.085	-3.965	0.631	-0.289	9.397	-0.013	-9.001	-3.489	-11.674	16.266
2	-40.697	51.403	-9.964	-3.412	2.390	0.106	2.645	-3.204	16.271	23.641
3	-5.074	.454	27.872	-4.453	1.842	0.013	3.892	10.771	-5.815	19.25
4	8.467	-13.136	6.089	-4.963	-6.357	0.022	2.808	-15.436	-13.563	16.22
5	-55.310	-31.956	-3.378	1.359	5.307	0.144	4.144	-1.916	-1.425	-42.844
6	-37.220	-2.400	4.821	-2.486	-9.828	0.097	-0.057	3.563	8.833	14.953
7	3.379	5.456	-22.978	3.436	-3.757	-0.409	1.593	8.982	-24.875	8.759
8	17.964	-0.569	6.610	21.616	-1.093	-0.947	0.591	-1.862	10.291	7.154
9	59.750	36.358	2.846	-3.944	0.758	-0.156	0.280	-0.662	-0.306	-48.621
10	43.655	-41.566	-12.282	-6.864	0.660	-0.113	1.006	3.252	22.354	15.128
VALUE	12033	6937.750	1678.626	605.957	291.371	-0.002	-199.150	-488.230	-1921.46	-6237.07
X VAR	55.847	32.198	7.79	2.812	1.352	0.001	2.251	5.519	21.721	70.507

Sum of Roots: - 12701.167

Warp factor: - 1.6965

(B) FARMERS

	1	2	3	4	5	6	7	8	9	10
1	38.78	-11.600	2.509	-14.300	-9.760	-0.941	3.637	-0.405	6.564	13.506
2	-38.464	-26.148	-0.152	7.630	-5.837	0.479	1.113	0.949	-6.200	-22.079
3	-29.470	31.533	4.296	-3.940	-5.583	2.250	-0.273	0.438	7.281	-20.941
4	2.461	6.553	16.803	14.518	-5.608	-9.278	-3.008	-0.003	-1.498	18.633
5	-2.644	-0.766	-10.615	-7.249	-8.251	12.829	-3.607	0.003	-8.904	17.765
6	-12.622	-3.656	-21.448	-2.042	11.598	-9.845	-3.720	0.916	5.584	-9.221
7	3.245	4.649	-12.240	13.236	3.704	0.018	4.830	-0.804	7.065	14.791
8	-1.245	12.575	5.368	-5.806	11.293	-3.335	3.028	0.802	-16.557	2.289
9	9.689	-13.843	22.259	-4.260	11.452	8.823	-1.658	-0.813	8.099	-1.590
10	65.766	0.705	-5.979	2.122	-4.308	-1.000	-0.342	-0.085	-1.935	-23.153
VALUE	6968.29	2241.38	1563.41	780.43	688.35	587.079	85.804	-0.012	-626.77	-2499.7
X VAR	53.956	17.355	12.106	6.043	5.33	4.546	0.564	0	20.947	79.953

Sum of Roots: - 9788.254

Warp Factor: - 1.3194

(C) INEXPERIENCED FARMER GROUP CO-ORDINATE SET

	1	2	3	4	5	6	7	8	9	10
1	-5.592	-0.755	29.079	9.430	-3.735	-2.425	-0.001	-1.849	1.358	13.629
2	-52.72	6.061	-5.305	-5.971	-3.069	-1.250	-0.015	0.362	-1.279	-33.126
3	-13.061	-21.120	7.618	6.092	-0.408	0.450	.050	2.225	7.322	.966
4	5.294	-3.529	-16.941	5.113	-9.302	1.583	.009	-1.258	2.297	14.345
5	-0.567	-3.975	-0.473	-11.177	1.479	6.073	.008	0.863	-8.200	11.894
6	-13.548	-8.211	-7.235	1.975	10.405	0.160	.019	-2.284	3.038	-1.849
7	8.047	7.598	-10.305	-5.150	2.924	-5.782	-0.018	1.66	-0.508	22.54
8	0.365	0.809	6.911	16.626	0.023	-1.604	.000	-0.137	-11.435	-1.594
9	3.872	26.355	6.043	6.068	1.661	3.404	-0.061	0.422	6.791	1.945
10	67.621	-3.233	-0.372	-4.140	-0.379	-0.616	0.007	-0.006	0.617	-28.75
Value	7842.364	1342.164	1017.985	673.62	233.311	95.944	-0.007	-10.995	-316.357	-2975.668
% Var.	69.991	11.981	9.085	6.012	2.082	.848	0	.574	9.555	49.871
Sum of Root:	- 7893.76									
Warp Factor:	- 1.4194									

(D) EXPERIENCED FARMERS CO-ORDINATE SET

	1	2	3	4	5	6	7	8	9	10
1	-10.79	-4.89	-0.395	-3.085	1.691	4.992	0.041	-8.310	.295	2.548
2	-6.42	13.85	10.7	-0.575	-13.612	-0.571	0.016	-1.384	-0.399	-15.744
3	67.804	-12.83	-7.160	3.860	1.254	0.777	-0.148	5.346	1.228	-37.637
4	6.599	-31.691	7.223	-16.857	-7.655	-0.253	-0.015	8.995	5.263	30.807
5	7.377	14.884	-2.041	28.772	-2.644	0.524	-0.017	7.214	-1.855	30.449
6	-6.767	39.05	4.049	-13.238	10.418	-0.149	0.014	6.844	9.922	-0.918
7	20.899	19.610	-18.849	-5.261	-17.152	-1.45	-0.046	-11.906	9.191	7.967
8	11.664	-1.564	-11.697	-8.002	12.206	-1.206	-0.026	-4.395	-23.241	12.146
9	-16.803	-27.323	11.243	12.961	15.614	-1.971	0.037	-9.257	10.001	-3.805
10	-65.565	-6.096	-22.265	1.118	-0.121	-0.694	0.144	6.852	-2.484	-25.814
VALUE	10289.33	4500.96	2898.94	1573.46	1347.46	34.128	-0.049	-573.088	-934.157	-4439.793
% VAR.	19.84	21.402	14.04	7.62	6.527	0.165	.001	9.636	15.708	74.655
Sum of Roots:	- 14697.238									
Warp Factor:	- 1.4046									

Appendix B: Rotated Co-ordinate Sets of the Experienced and Inexperienced Groups
 Securities Management: An Analysis of 10 Concepts Utilizing 2 Sets of Data
 The Rotated Co-ordinates of Experienced Group

	1	2	3	4	5	6	7	8
1 High Pec	-12.694	14.900	-3.809	6.883	4.673	2.622	0.028	-8.653
2 Reduced	-0.325	33.640	37.286	9.393	-10.640	-2.941	0.001	-1.727
3 Multiple	73.899	6.960	-10.582	13.828	4.236	-1.593	-0.161	5.004
4 Self	12.694	-14.900	3.809	-6.883	-4.673	-2.622	-0.028	8.653
5 Two Body	13.472	31.674	-6.255	38.740	8.339	-1.845	-0.030	6.812
6 Multiple	-0.672	58.840	0.634	-3.271	21.401	-2.519	0.001	6.502
7 Multiple	26.994	39.401	-22.263	4.717	-14.169	-3.819	-0.059	-12.248
8 Later La	17.760	18.226	-15.111	1.966	15.188	-3.575	-0.039	-4.738
9 Set Stoc	-10.708	-7.533	7.829	22.929	18.597	-4.340	0.024	-9.539
10 Sumner P	-59.478	13.694	-25.679	11.386	-5.139	-3.063	0.131	6.510

	9	10
1 High Pec	-2.484	-14.129
2 Reduced	-11.178	-32.422
3 Multiple	-1.551	-54.314
4 Self	2.484	14.129
5 Two Body	-4.635	13.772
6 Multiple	7.143	-17.596
7 Multiple	6.412	-8.710
8 Later La	-26.020	-4.531
9 Set Stoc	7.303	-20.483
10 Sumner P	-5.263	-42.481

18 1 Dimension numbers 1 to 6 are in real Euclidean space.

2 Dimension numbers 7 to 10 are in imaginary Euclidean space.

The Related Co-ordinates of the associated Space

	1	2	3	4	5	6	7	8
1 High Fee	12 119	11 362	3 596	6 500	1 070	2 070	0 000	-0 330
2 Deduced	-31 600	11 834	10 063	25 204	-12 208	-6 310	0 020	17 297
3 Multiple	10 031	8 950	8 320	6 927	10 143	0 752	-0 005	10 432
4 Self	12 119	-14 362	3 596	6 500	-1 070	2 070	-0 000	0 330
5 Use Body	-2 303	-0 063	1 040	3 732	7 076	-10 187	-0 003	-2 351
6 Multiple	6 519	5 959	10 331	-10 002	11 028	-0 354	-0 015	5 010
7 Multiple	16 235	1 907	11 622	2 570	2 003	-2 702	0 023	-1 700
8 Water La	6 200	3 004	-1 070	-13 059	0 170	11 777	0 005	0 430
9 Set Stoc	16 700	23 008	1 301	-12 600	3 507	-3 023	0 006	0 302
10 Sumner P	10 210	-14 002	-25 020	32 700	10 762	0 304	-0 002	16 316

	1	10
1 High Fee	-0 070	-0 506
2 Deduced	3 059	-42 057
3 Multiple	5 617	-0 502
4 Self	0 070	0 506
5 Use Body	0 016	-5 943
6 Multiple	5 033	-13 602
7 Multiple	6 004	6 999
8 Water La	6 052	10 664
9 Set Stoc	6 001	0 202
10 Sumner P	10 200	-30 190

10 1 Dimension numbers 1 to 6 are in real Euclidean space.
 2 Dimension numbers 7 to 10 are in imaginary Euclidean space.

The Rotated Co-ordinates of Inexperienced Group

	1	2	3	4	5	6	7	8
1 High fec	-12.149	11.362	-3.596	6.588	4.470	2.478	8.004	-0.330
2 Reduced	-31.600	11.694	30.863	-25.204	-12.208	-6.940	0.020	17.297
3 Multiple	-18.831	-9.658	0.328	-6.827	19.143	8.752	-0.045	10.432
4 Self	12.149	-11.362	3.596	-6.588	-4.470	-2.478	-0.004	0.330
5 Eye Body	-2.303	-0.463	4.408	3.732	7.676	-10.197	-0.903	-2.151
6 Multiple	-6.519	-5.959	16.331	-10.682	11.926	-0.354	-0.015	5.810
7 Multiple	16.295	1.907	11.622	2.578	2.893	-2.782	0.023	-1.708
8 Later La	4.290	3.084	-4.478	-13.459	8.178	11.777	0.905	0.438
9 Set Stoc	16.780	23.848	-1.381	-12.640	3.597	-3.023	0.966	0.382
10 Sumner P	19.218	-11.082	-25.420	32.790	18.762	0.994	-0.002	16.316

	9	10	
1 High fec	-0.879	-0.566	XB 1 Dimension numbers 1 to 6 are in real Euclidean space. 2 Dimension numbers 7 to 10 are in Imaginary Euclidean space.
2 Reduced	9.869	-42.853	
3 Multiple	5.617	-0.582	
4 Self	0.0779	0.566	
5 Eye Body	-0.416	-5.943	
6 Multiple	5.433	-13.602	
7 Multiple	-6.084	6.999	
8 Later La	-6.452	-19.464	
9 Set Stoc	6.001	-0.202	
10 Sumner P	10.280	-38.190	

Appendix: 7:0 Procrustes Rotation of the Experienced and Expert Groups.

Recruitment Management : An Analysis of 10 Concepts Utilizing 2 Sets of DataThe Rotated Co-ordinates of Experienced Group

	1	2	3	4	5	6	7	8
1 High Fee	-12.694	14.900	-3.809	6.883	4.673	2.622	0.000	0.028
2 Reduced	-0.325	33.640	37.286	9.393	-10.630	-2.941	0.000	0.001
3 Multiple	73.899	6.960	-10.582	13.828	4.236	-1.593	0.000	-0.161
4 Self	12.694	-14.900	3.809	-6.883	-4.673	-2.622	0.000	-0.028
5 Eye Body	13.472	34.674	-6.255	38.740	0.339	-1.845	0.000	-0.030
6 Multiple	-0.672	58.840	0.634	-3.271	21.001	-2.519	0.000	0.001
7 Multiple	26.994	39.101	-22.263	1.707	-14.169	-3.819	0.000	-0.059
8 Later La	17.760	18.226	-15.111	1.966	15.188	-3.575	0.000	-0.039
9 Set Stock	-10.708	-7.533	7.829	22.929	18.597	-4.340	0.000	0.024
10 Sumner P	-59.470	13.694	-25.679	11.386	-5.139	-3.063	0.000	0.131

The Rotated Co-ordinates of Space Number 1

	9	10	11
1 High Fee	-8.653	-2.484	-14.129
2 Reduced	-1.727	-11.178	-32.422
3 Multiple	5.004	-1.551	-54.314
4 Self	8.653	2.484	14.129
5 Eye Body	6.872	-4.635	13.772
6 Multiple	6.502	7.143	17.596
7 Multiple	-12.248	6.412	-8.710
8 Later La	-1.738	-26.020	-4.531
9 Set Stock	-9.599	1.303	-20.483
10 Sumner P	6.510	-5.263	-42.491

The Related Co-ordinates of Expert Group

	1	2	3	4	5	6	7	8
1 High Fec	-5.902	6.932	-1.859	3.403	2.225	1.234	0.003	0.044
2 Reduced	-51.139	38.867	25.863	-14.113	-30.902	-8.610	11.452	-19.458
3 Multiple	-5.487	-0.048	26.927	-2.210	8.526	-6.868	9.951	-16.700
4 Self	5.902	-6.932	1.859	-3.403	-2.225	-1.234	-0.003	-0.044
5 Ewe Body	-55.722	-34.822	-1.500	-6.902	0.354	-10.332	4.731	9.666
6 Multiple	-34.745	-12.438	16.803	-11.542	-14.019	-11.683	6.197	-0.293
7 Multiple	-8.985	12.549	-12.602	0.448	-23.740	1.155	3.337	-3.698
8 Later La	8.591	6.260	4.368	23.843	-8.309	-5.189	8.753	-10.919
9 Set Stoc	42.700	52.111	6.741	6.493	-10.875	9.006	3.587	12.633
10 Summer P	33.137	-14.373	-34.565	3.236	7.309	12.111	13.721	-20.937
11	0.000	0.000	0.000	0.000	0.000	0.000	0.000	0.000

The Related Co-ordinates of Expert Group

	9	10	11
1 High Fec	-4.864	-1.271	-6.861
2 Reduced	9.214	-17.463	-7.864
3 Multiple	-10.460	-0.159	-5.117
4 Self	4.864	1.271	6.861
5 Ewe Body	-34.927	-38.334	30.345
6 Multiple	-21.404	-33.508	2.876
7 Multiple	-21.381	8.931	3.181
8 Later La	-3.308	-21.649	-0.133
9 Set Stock	-39.288	-42.992	29.723
10 Summer P	1.223	-26.542	-8.381
11	0.000	0.000	0.000

Distances Moved in the Interval between line 1 and line 2

Concept 1	(High Fecundity)) moved	8.052 units
Concept 2	(Reduced Stocking Rate)) moved	49.633 units
Concept 3	(Multiple Lamb Survival)) moved	70.345 units
Concept 4	(Self)) moved	8.052 units
Concept 5	(Ewe Body Condition)) moved	92.308 units
Concept 6	(Multiple Lamb Birthweight)) moved	70.860 units
Concept 7	(Multiple Lamb Growth Rates)) moved	44.601 units
Concept 8	(Later Lambing)) moved	37.477 units
Concept 9	(Set Stocking)) moved	40.302 units
Concept 10	(Summer Pasture Control)) moved	87.280 units

The mean distance between all points in Space 1 and their counterparts in Space 2 is 50.900.

Appendix 8:0 Rotated Co-ordinates of the Inexperienced and Expert Groups
Security Management: An Analysis of 10 Concepts Utilising 2 Data Sets
 (1) The Rotated Co-ordinates of Inexperienced Group

	1	2	3	4	5	6	7	8
1 High Fec	-5.299	1.787	18.485	-7.272	2.784	-2.004	0.000	-0.004
2 Reduced	-52.716	8.203	6.849	-5.812	3.450	-0.829	0.000	-0.020
3 Multiple	-13.057	-18.978	6.104	8.251	6.111	8.879	0.000	0.045
4 Self	5.298	1.387	-18.485	7.272	-2.784	2.004	0.000	0.004
5 Ine Body	-0.563	-1.833	-2.017	-8.819	8.397	6.495	0.000	8.003
6 Multiple	-13.544	-6.069	-8.779	4.133	16.924	8.581	0.000	0.015
7 Multiple	8.051	9.741	-11.849	-2.898	9.442	-5.361	0.000	-0.023
8 Later La	0.369	2.951	5.367	18.784	6.542	-1.183	0.000	-8.005
9 Set Stoc	3.876	28.497	4.499	8.226	8.180	3.825	0.000	-8.056
10 Sumner P	87.625	-1.091	-1.916	-1.981	6.140	-8.194	0.000	0.002
11	0.000	0.000	0.000	0.000	0.000	0.000	0.000	0.000

	9	10	
1 High fec	-8.295	-8.169	-8.358
2 Reduced	1.916	-3.106	-47.114
3 Multiple	3.779	5.495	-13.021
4 Self	8.295	8.169	8.358
5 Ine Body	2.416	-10.027	-2.894
6 Multiple	-8.730	1.210	-15.836
7 Multiple	3.213	-2.336	8.553
8 Later La	1.417	-13.262	-15.582
9 Set Stoc	1.976	4.964	-12.842
10 Sumner P	1.548	-1.210	-42.738
11	0.000	0.000	0.000

Eccentricity Management : 10 Inexperienced vs Expert : An Analysis of 10 Concepts Utilizing 2 Sets of Data
The Related Co-ordinates of Expert Group

	1	2	3	4	5	6	7	8
1 High Tec	-2.684	0.588	8.915	-3.698	1.428	-1.012	0.008	-0.063
2 Reduced	-23.913	18.676	50.099	15.557	-48.380	3.123	3.750	-20.168
3 Multiple	-23.535	8.090	-8.641	-2.209	-11.185	-2.876	3.193	-19.934
4 Self	2.684	-0.588	-8.915	3.698	-1.428	1.012	-0.008	0.063
5 Eye Body	-32.405	-45.419	12.103	16.129	-15.775	26.573	-8.034	-3.065
6 Multiple	-22.392	-13.332	7.638	15.993	-30.222	14.279	-3.456	-7.416
7 Multiple	17.390	0.201	22.082	4.530	-11.538	4.131	0.065	-8.009
8 Water La	18.091	4.321	-1.254	-23.895	-8.987	-1.930	0.767	-14.340
9 Set Stoc	29.518	53.914	6.691	-15.501	2.513	-27.524	-8.886	-0.650
10 Sumner P	33.444	-18.185	-16.480	-1.143	34.808	-1.782	3.284	-23.799
11	0.000	0.000	0.000	0.000	0.000	0.000	0.000	0.000

	9	10	11
1 High Tec	-3.841	-6.012	-4.636
2 Reduced	17.764	-14.910	-1.675
3 Multiple	-6.981	-5.873	-4.771
4 Self	3.841	6.012	4.636
5 Eye Body	-21.017	-26.849	49.195
6 Multiple	-7.959	-32.349	21.235
7 Multiple	-22.348	2.019	0.791
8 Water La	6.189	-18.459	9.499
9 Set Stoc	-23.839	-32.321	52.492
10 Sumner P	13.808	-25.006	3.111
11	0.000	0.000	0.000

BIBLIOGRAPHY

1. Ajzen, I. and Fishbein, M. 1980
Understanding Attitudes and Predicting Social Behaviour.
Prentice-Hall Inc.
2. Alexander, G. 1974
Birthweight of Lambs: influences and consequences.
From: Size at Birth. Ciba Foundation Symposium 27 (new
series) A.S.P. Amsterdam, pp 121-124.
3. Allison A.J. and Kelly R. 1978
Sheep: Booroola Merinos, High Fertility Crossing Sires.
M.A.F. Aglink FPP 283.
4. Allport, G.W. 1935
in Attitudes and Behaviour.
Edited by K. Thomas pp 17 - 21
Penguin Books Ltd, London.
5. Armstrong, 1980
Evaluation of an Advisory Programme.
unpubld paper N.Z. Institute Agricultural Science
Convention.
6. Bannister, D. and Fronsella, Fay. 1971
Inquiring Man: The Theory of Personal Constructs.
Penguin Books Ltd, London.
7. Barnicoat, C.R.; Logan, A.G. and Grant, A.I. 1949
Milk Secretion Studies with N.Z. Romney Ewes, Pts I and II.
J. Agr. Sci. Camb. Vol. 39, pp 33; 44; 237.
8. Barnicoat, C.R.; Murray, P.F.; Roberts, E.M. and Wilson, G.S. 1957
Milk Secretion Studies with New Zealand Romney Ewes.
Pts V and VI. Experimental yield and composition of
ewes milk in relation to growth of the lamb.
J. Agr. Sci. Camb. Vol. 48, pp 9-35.

9. Binnie, D.B. 1983
The relationship between Growth and Production.
Chapter 3 of Lamb Growth Animal Industries Workshop
Technical Handbook.
Lincoln College.
10. Bird, P.R.; Lynch, J.J. and Obst, J.M. 1984
Effect of Shelter on Plant and Animal Production.
J. Anim. Prod. Aust. Vol. 15, pp 31 -
11. Black, J. 1926
Introduction to Production Economics.
Henry Holt, New York.
12. Black, P.D. 1985
Management to achieve high total Weaning Weight.
Proc. Invermay Farmers Field Day, pp 27-31.
13. Blackie, M.J. and Dent, J.B. 1974
The concept and application of skeleton models in farm
business analysis and planning.
J. Agric. Econ. Vol. 25.
14. Bourke, I.J. 1978
The effect of a preliminary letter on response rate
and speed of reply in a mail survey.
Research report No.19 Marketing Dept Massey Univ.
Palmerston North.
15. Bradford, L.A. and Johnson, G.L. 1953
Farm Management Analysis
Wiley, New York.
16. Cary, J.
Personal Communication.
Lecturer University of Melbourne, Australia.

17. Checkland, P.B. 1979
Techniques in 'Soft' Systems Practice
Part 1: System Diagrams - and Part 2: Building Conceptual
Models.
J. Applied Systems Analysis, Vol. 6, pp 33-49.
18. Checkland, P.B. 1981
Rethinking a systems approach.
J. Applied Systems Analysis, Vol. 8, pp 7-13.
19. Clarke, J.N. 1972
Current levels of performance in the Ruakura Fertility
flock of Romney Sheep.
Proc. N.Z. Animal Prod. Society Vol. 32, pp 29-34.
20. Concise Oxford Dictionary, 1964
5th Edition.
Clarendon Press, Oxford.
21. Coop, I.E. and Drew, K.R. 1963
Maintenance and lactation requirements of grazing sheep.
Proc. Anim. Prod. Soc. Vol. 23, pp 53-61.
22. Cronin, M.B. 1968
A study of factors hindering increased production on
the Rangitaiki plains and in Galatea.
Unpubld. M.Ag.Sc. Thesis, Massey University:
23. Cushman, P.D. and McPhee, R.D. 1980
Attitudes, Behaviours and Messages: An introductory
overview. Chapter one in Communications, Attitudes
and Behaviour.
Ed. D.P. Cushman, Academic Press, New York.
24. Dalton, D.C. 1980
Sources of perinatal mortality.
Proc. Lincoln College Farmers Conference, pp 109-123.

25. Dalton, D.C. and Rae, A.L.
The New Zealand Romney Sheep: A Review of Productive Performance.
Animal Breeding Abstracts, Commonwealth Bureau of Animal Breeding and Genetics.
Vol. 46, Dec. 1978, pp 81-87.
26. Davis, G.H. 1983
Boorollas: The Major Gene Effect.
Aglink A.S.T. 101 Ministry Agriculture and Fisheries.
27. Davis, G.H. 1984
Feeding the Pregnant Ewe.
Paper presented to Coopworth Sheep Society Annual Conference.
28. Davis, G.H. 1985
Options for Increasing Prolificacy in Sheep.
Proceedings Invermay Farmers Yield Day.
29. Davis, G.H.; Montgomery, G.W.; Allison, A.J.; Kelly, R.W. and Bray, A.R. 1982
Segregation of a major gene influencing fecundity in progeny of Booroola sheep.
N.Z. Jnal Agric. Res. Vol. 25, pp 71-78.
30. Davis, G.H.; Kelly, R.W.; Hanrahan, R.W. and Rohloff R.M. 1983
Distribution of Litter sizes within flocks at different levels of Fecundity.
Proc. N.Z. Soc. Animal Production Vol. 43, pp 25-28.
31. Davis, G.H.; Rohloff, R.M. and Kelly, R. 1985
Higher lamb drop, calls for new style management.
N.Z. Farmer, Vol. 106, No. 27, November 28.
32. deLisle, J.F. and Patterson, D.E. 1971
The climate and weather of the Hawkes Bay region, New Zealand.
Ministry of Transport, N.Z. Met Service Misc. Publ. 115(5).

33. Dick, A.M.P. 1985
Rats on Kapiti Island, N.Z.: Coexistence and diet of RATTUS nonegicus Berkenhaut and RATTUS exulans Peale.
Masterate Thesis, Massey University, New Zealand, 1985.
34. Dickerson, G.E. 1978
Animal size and efficiency: Basic concepts.
Anim. Prod. Vol. 27, pp 367-379.
35. Dillon, J.L. 1980
The definition of Farm Management.
Aust. Journal Ag. Economics, 1980 pp 257-258
36. Donald, H.P. and Russell, W.S. 1970
The relationship between liveweight of ewe at mating
and the weight of new born lamb.
Anim. Production, Vol. 12.
37. Doubleday Dictionary, 1975
Doubleday and Co Ltd.
Garden City, N.Y.
38. Doyle, L.B. 1975
Information Retrieval and Processing.
Wiley - Beckerand Hayes. Melville Publ. Co. L.A. California.
39. Duff, X.J. 1981
An Investigation of Perinatal Lamb Mortality in a flock
of Romney Ewes in the Wairarapa district of New Zealand.
Dissertation, Dip. Agri. Science.
Massey University.
40. Dunn-Rankin, P. 1983
Scaling Methods.
Lawrence Erlbaum Associates, Publishers London. 1983.

41. Emery, F.E. and Oesar, O.A. 1958
Information, Decision and Action. A study of the psychological determinants of changes in farming techniques.
Melbourne, Melbourne University Press, 1958.
42. Fennessey, P. 1985
Lean Lamb Production.
Invermay Infosheet No. 11, M.A.F. 1985.
43. Feber, R. 1974
Handbook of Marketing Research.
Edited by R. Feber. McGraw-Hill Inc, 1974.
44. Festinger, L.A. 1957
A Theory of Cognitive Dissonance.
Stanford, C.A.: Stanford University Press, 1957.
45. Fishbein, M. and Ajzen, I. 1975
Belief, Attitude, Intention and Behaviour: An introduction to theory and research.
California, Addison-Wesley Publishing Co. 1975.
46. Forster, G.W. 1946
Farm Organisation and Management.
Revised Ed. N.Y. Prentice-Hall Inc., 1946.
47. Geenty, K. 1979
Lactation performance, growth and carcass composition of sheep.
N.Z. Jnal Ag. Research, Vol. 22, 1979.
48. Geenty, K. 1983
Pasture feeding for maximum lamb growth.
Lamb Growth Workshop - Animal Industries Workshop, Technical Handbook. Lincoln College, 1983.

49. Geenty, K. and Sykes, A.R. 1983
Feed requirements of the lamb between birth and weaning.
Lamb Growth Workshop - Animal Industries Workshop,
Technical Handbook. Lincoln College 1983.
50. Gibbs, D.B. 1973
A Review of the Adoption, Diffusion and Communication
of New Ideas and Practices in Rural Situations.
Occasional Paper No. 7, Dept. of Agricultural Economics
and Farm Management, Massey University, N.Z. 1973.
51. Glover, A.F. 1972
Milk Production in the Ewe (A Review).
2nd Seminar Sheep and Beef Cattle Society of N.Z. Vet.
Assoc. (1972), pp 22-29.
52. Gower, J.C. 1975
Generalised Procrustes Analysis.
Psychometrika Vol. 40, No. 1, March 1975, pp 33-51.
53. Green, P.E. 1975
Marketing Applications of M.D.S. Assessment and Outlook.
Jnal of Marketing, Vol. 39, pp 73-81.
54. Green, P.E. and Carroll, J.D. 1978
Mathematical Tools for Applied Multivariate Analysis.
Academic Press, N.Y. 1978.
55. Green, P.E. and Tull, D.S. 1978
Research for Marketing Decisions.
4th Edition. Prentice-Hall, 1978.
56. Greenberg, M.G. and Green, P.E. 1971
Multidimensional Scaling. Chapter 3 in Handbook of
Marketing Research. Edited by R. Ferber. (ibid).

57. Greer, J.P. 1982
Motivation and other Factors influencing the adoption of practices by Sheep Farmers in Oxford County, New Zealand.
Unpubld M.Ag.Sc. Thesis
Lincoln College, N.Z. 1982.
58. Hall, D.G. 1979
Importance of Ewe Reproduction in the Efficiency of Lamb Production.
Aust. Anim. Prod., Vol. 15, 1979, pp 66-69.
59. Haughey, K.G. 1983
Improved Lamb Survival - A challenge to the Industry, both Stud and Commercial.
Wool Technology and Sheep Breeding, Dec. 1983.
60. Hawker, H. 1984
Wool Production and Multiple Births. No bad effects.
N.Z. Farmer, April 12, Vol. 105, No. 7, 1984.
61. Heider, 1958
The Psychology of Interpersonal Relations.
John Wiley, N.Y. 1958.
62. Hight, G.K. and Jury, K.E. 1970
Lamb Mortality.
Proc. Ruakura Farmers Conference, pp 78-91.
63. Hinch, G.W. 1983
Causes of Lamb Mortality in High Fecundity Flocks.
Invermay Infosheet No. 8, M.A.F. 1983.
64. Hinch, G.W. 1983
Lamb Mortality in High Fecundity Flocks.
Invermay Infosheet No. 6, M.A.F. 1983.

65. Hodgson, J. 1971
Influence of Sward Characteristics on Diet Selection
and Herbage Intake by the Grazing Animal.
H.F.R.O. Annual Report, 1971, pp 153-166.
66. Hughes, A.H.
Measurement of Attitudes - undated mimeograph.
Massey University, N.Z.
67. Hughes, G.D. 1971
The Measurement of Belief and Attitudes.
Chapter 2 in: Handbook of Marketing Research. Edited
by R. Ferber. (ibid).
68. Hughes, A.H.; Squire, J.D. and Payne, W.G. 1973
An Evaluation of the Rangitaiki Plains Dairy Company
Cronin Pilot Advisory Scheme.
Occasional Paper, No. 5, Dept. Ag. Economics and Farm
Management, Massey University N.Z., 1973.
69. Jagusch, K.T. 1977
Nutrition and Growth of the Pre-Weaned Lamb.
Proceedings of N.Z. Veterinary Assoc., 6th Sheep and
Beef Seminar, 1977, pp 117-123.
70. Jensen, H.R. 1977
Farm Management and Production Economics 1946-1970.
In. - A survey of Agricultural Economics Literature. Vol. One.
Traditional fields of Agricultural Economics 1940's
to 1970's.
Ed. Lee Martin, North Central Publ. Co., St Paul, 1977.
71. Kaplowitz, S.A. and Fink, E.L. 1982
Attitude change and Attitudinal Trajectories. A dynamic
Multidimensional Theory of Attitude and Belief change.
Paper to International Communication Assoc. in Boston 1982.

72. Kelly, R.W. 1979
Sheep: Reproductive Performance
Aglink, F.P.P. 221 M.A.F. 1979.
- 72(a) Kelly, G.A. 1955
The Psychology of Personal Constructs.
Vol. I, N.Y. Norton and Co Inc., 1955.
- 72(b) Keith-Lucas, A. 1957
Some Casework Concepts for the Public Welfare Worker.
Chapel Hill, Univ. of Nth Carolina Press, 1957.
73. Khalaf, A.M.; Doxey, D.L.; Baxter, J.T.; Black, W.J.M.;
Fitzsimmons, J; and Ferguson, J.A. 1979
Late Pregnancy Ewe Feeding and Lamb Performance in
Early Life (1).
Animal Production. Vol. 29, 1979, pp 393-397.
74. Kilgour, R. 1982
Lamb Survival. The Birthsite is critical.
N.Z. Jnal Agriculture, August 1982, pp 8-9.
75. Kirton, A.H. 1981
Sheep: Meat from Entire Ram Lambs.
M.A.F. Aglink, FPP 510, 1981.
76. Kirton, A.H.; Clarke, J.H. and Hickey, S.M. 1982
A comparison of the composition and carcass quality
of Kelly and Russian castrate, ram, wether and ewe
lambs.
Proc. N.Z. Soc. Anim. Production, Vol. 42, 1982.
77. Klecka, W.R. 1980
Multiple Discriminant Analysis. In S.P.S.S. - Statistical
Package for Social Sciences Ed. N.H. Nie et al.
McGraw-Hill. Revised Edition, 1980.

78. Knight, T.W.; Hight, G.K. and Winn, G.W. 1982
The Influence of Sires on Lamb Survival.
N.Z. Society Animal Production, Vol. 42, 1982.
79. Knight, T.W.; McMillan, W.H. and Kilgour, R.G. 1983
Effect of Slope on Lamb Survival.
M.A.F. Annual Research Report, 1982-1983.
80. Korth, B. and Tucker, L.R. 1976
Procrustes Matching by Congruence Coefficients.
Psychometrika Vol. 41, No. 4, Dec. 1979, pp 531-534.
81. Krech et al 1962 - cited in Fishbein and Ajzen (ibid).
82. Kruskal, J.B. and Wish, M. 1978.
Multidimensional Scaling.
Beverly Hills Calif. Sage, 1978.
83. Large, R.V. 1970
Efficiency of Lamb Production.
Anim. Prod. Vol. 12, 1970, pp 393.
84. Liska, A.E. 1974
Emergent Issues in the Attitude - Behaviour
Consistency Controversy.
American Sociological Review, Vol. 39, 1974, pp 261-272.
85. Loftus, L. and Cary, J.W. 1980
Towards an Understanding of Management Education in
Agriculture.
School of Agriculture and Forestry.
University of Melbourne, 1980.
86. Luke, J. 1968
Soils of New Zealand Pt 1.
Soil Bureau Bulletin, Vol. 26, Pt 1, N.Z. D.S.I.R., 1968.

87. M.A.F. 1982
Management for Successful Lamb Fattening
Waimate, M.A.F. 1982.
88. M.A.F. 1985
Farm Monitoring Report: Sheep and Beef - November 1984.
Advisory Services Division of M.A.F. Wellington,
N.Z., 1985.
89. Mahoney, M.J. 1974
Cognition and Behavioural Modification.
Ballanger Publ. Co., 1974.
90. Marlier, J.T. 1976
Respondent Self-Concept and Responses to Scaling Tasks.
Communication Yearbook No. 7, Edited by Bostrom,
Dec. 1976.
91. Maughan, C.W. 1980
A Conceptual Framework for Collecting and Analysing
Information on Farmers' Intentions to Increase Production.
Internal Discussion Paper, Dept. Agricultural Economics
and Farm Management, Massey University, N.Z. 1980.
92. McCance, I. and Alexander, G. 1959
The Onset of Lactation in the Merino Ewe and its
Modification by Nutritional Factors.
Aust. Jnal Agri. Res. Vol. 10, 1959.
93. McCutcheon, S.N.; Holmes, C.W. and McDonald, M.F. 1981
The Starvation Exposure Syndrome and Neonatal Lamb
Mortality: A Review.
Proc. N.Z. Soc. Anim. Prod. Vol. 41, 1981, pp 209-217.
94. McCutcheon, S.N.; Holmes, C.W. and McDonald, M.F. 1983
Resistance to Cold Stress in the Newborn Lamb: Responses
to Romney, Drysdale X Romney and Merino lambs to components
of the Thermal Environment.
N.Z. Jnal Ag. Res. Vol. 26, pp 169-174.

95. McCutcheon, S.N.; Holmes, C.W. and McDonald, M.F. (1983)
Resistance to Cold Stress in the Newborn Lamb.
2: Role of Bodyweight, Birthrank and some Birthcoats
Characters as determinants of resistance to cold stress.
N.Z. Jnal Agric. Res., Vol. 26, pp 175-181.
96. McEwan, J.C.; Mathieson, C. and Hawker, H. 1983
Date of Lambing and Sheep Production during Lactation
in Southland.
Proc. N.Z. Soc. of Anim. Prod. Vol. 43, 1983, pp 45-48.
97. McNeil, P.; Willis, B.W. and Rhodes, T. 1985
An Evaluation of the Dannevirke Planned Animal Health
Advisory Programme (PAHAPS) 1985.
98. McSporrnan, K.D.; Buchanan, R.; Fidden, E.D. 1977
Observation on Dystocia in a Romney Flock.
NZ Vet Journal, Vol. 25, 1977, pp 247-251.
99. Mead, G.H. 1934
Mind, Self and Society.
University of Chicago Press, 1934.
100. Meyer, H.H. and Clarke, J.N. 1978
Genetic and Environmental Effects on incidence and
causes of Lamb Mortality.
Proc. NZ Soc. Anim. Prod. Vol 38, 1978, pp 181-185.
101. Musser, W.N.; Wetzsein, M.E.; Reece, S.Y.; Varca, P.E.;
Edwards, D.M. and Douce, G.K. 1986
Beliefs of Farmers and Adoption of Integrated Pest
Management.
Ag. Econ. Research, Vol. 38, No. 1, 1986, pp 34-44.
102. Myers, J.H. and Alpert, M.I. 1968
Determinants of Buying Attitudes: Meaning and
Measurement.
Journal of Marketing, Vol. 32, 1968.

103. Nix, J. 1979
Farm Management: The State of the Art (or Science).
J. Agr. Economics, Vol. 30, 1979, pp 277-291.
104. Nunnally, J.C. 1967
Psychometric Theory
McGraw-Hill Book Co., N.Y., 1967
105. Nie, N.H.; Hull, G.H.; Jenkins, J.G.; Steinbrenner, K.
and Bert, D.H. 1974
SPSS - Statistical Package for the Social Sciences
(2nd Ed.).
McGraw-Hill and Cook Co., N.Y., 1974.
106. Osgood, C.E. and Succi, G.J. 1957
The Measurement of Meaning.
Urbana: University of Illinois Press, 1957.
107. Oskamp, S. 1977
Attitudes and Opinions
Toronto, Prentice-Hall Inc., 1977.
108. Owen, J.B. 1957
A Study of the Lactation and Growth of Hill Sheep in
their Native Environment and Under Lowland Conditions.
J. Agric. Science, Camb. Vol. 48, 1957, pp 387-409.
109. Owens, J. 1984
Managing Prolific Flocks.
Proc. Ruakura Farmers Conference, 1984, pp 50-53.
110. Owens, J. 1985
Sheep Prolificacy and Management for Lamb Survival.
In. Proc. Invermay Farmers Field Day, 1985.

111. Parker, W.J. 1984
"A Study of Management Practices and Productive Performance on a Sample of Hill Country Sheep Farms in North-East Wairarapa."
Unpubld M.Ag.Sc. Thesis, Massey University, New Zealand, 1984.
112. Parker, W.J. 1985
The Effects of Differential Set Stocking Rates on the Performance of Single and Twin Bearing Ewes during the Lambing to Weaning Period.
Chapter 2 Pregnancy Diagnosis and its benefits.
Public No. 2, Massey Farm Series, Massey Univ.
113. Parker, B.W.; Hight, G.K. and Cullen, N.A. 1975
Meat and Wool - Techniques for Increasing Production.
Aglink FPP 24, Advisory Services and Research Divisions M.A.F., 1975.
114. Peart, J.N. 1967
The Effect of Different Levels of Nutrition during late Pregnancy on the subsequent Milk Production of Black Faced Ewes and on the growth of the Lambs.
J. Ag. Sc. Camb., Vol. 68, 1967, pp 55-69.
115. Rattray, P.E. 1977
Energy Requirements for Pregnancy in Sheep.
NZ Soc. Animal Production, Vol. 34, 1977.
116. Rattray, P.E. 1978
Pasture Constraints to Sheep Production.
Proc. Agronomy Society, NZ, Vol. 8, 1978, pp 103-107.
117. Rattray, P.E. and Trigg, T.E. 1979
Minimal Feeding of Pregnant Ewes.
Proc. NZ Soc. Anim. Prod., Vol. 39, 1979, pp 242-250.

118. Robinson, J.J. 1983
Nutrient Requirements of the Breeding Ewe.
Chapter 10 Feeding the Ewe (unpubld).
Nottingham Manufacturers Conference, Jan. 1983.
119. Rogers, E.M. and Shoemaker, F.F. 1971
Communication of Innovations, 2nd Ed.
The Tree Press, N.Y. (1971).
120. Rohloff, M. 1981
Top Producing Farmers, Tell how to do it.
In. Flock and Herd No. 5, M.A.F., Oct. 1981.
121. Rohloff, M. 1983
Lamb Survival
Invermay Infosheet No. 1, M.A.F. 1983.
122. Rohloff, M. 1984
Management of Prolific Sheep Flocks.
Proc. Lincoln College Farmers Conf., 1984, pp 16-26.
123. Rohloff, M. 1985
Management of High Fecundity.
Notes presented to Glaxo Fecundin Seminar, Invermay,
1985.
124. Rohloff, M. and Hinch, G.N. 1984
Production from some Prolific Commercial Flocks in
New Zealand.
Aust. Jnal Anim. Production, Vol. 15, 1984, pp 742-743.
125. Russell, A. 1985
Nutrition of the Pregnant Ewe - In Practice.
Publd. by British Veterinary Assn., 1985.

126. Salmon, P.W. 1980
A Psychological Investigation of Farm Management Education: A Personal Construct Theory Approach to Agricultural Extension.
School of Agriculture and Forestry, University of Melbourne, Nov. 1980.
127. Scales, G.H. 1968
Lactation Performance of Romney, Corriedale and Merino Ewes in a Tussock Grassland Environment.
NZ J. Agric. Research, Vol. 11, 1968, pp 155-170.
128. Schonemann, P. 1966
A Generalised Solution of the Orthogonal Procrustes Problem.
Psychometrika Vol. 31, 1966, pp 1-10.
129. Schuman, H. and Johnson, M.P. 1976
Attitudes and Behaviour.
Annual Review of Sociology, Vol. 2, 1976, pp 12-21.
130. Scobie, G. and Jones, T. 1983
Economic Implications of Fecundin Immunisation.
Confidential Report, Glaxo, NZ, 1983.
131. Scott, J.D.J.; Lamont, N.; Smeaton, D.C. and Hudson, S.J. 1976
Sheep and Beef Cattle Nutrition.
Report by Agricultural Research Division of M.A.F., 1976.
132. Shocker, A.D. and Srinivasan, V. 1979
Multi-Attribute Approaches for Product Concept Evaluation and Generation: A critical review.
Jnal of Marketing Research, Vol. XVI, 1979.
133. Slee, J. 1978
The Effects of Breed, Birthcoat and Bodyweight on the Cold Resistance of Newborn Lambs.
Anim. Production Vol. 27, 1978.

134. Smeaton, D.C.; Rattray, P.V.; Mackisack, B.; Heath, S. and Hockey, H.U.P. 1983
Nutrition and Management of Ewes before and after Lambing.
Proc. NZ Soc. Animal Production Vol. 43, 1983, pp 37-40.
135. Smith, J.F. 1983
Towards Multiple Ovulations - Steroid Immunisation Techniques and Results.
Proc. Sheep and Beef Cattle Society of NZ Vet. Assoc. 13th Seminar, 1983, pp 35-43.
136. Smith, J.F. 1984
Teleconference Seminar on "Fecundin".
Oct. 1983 Proceeding. Published 1984.
137. Smith, M. et al. 1979
Farm Production Gains following the Adoption of a Hill Country Grazing Management System.
NZ Soc. Anim. Prod. Vol. 39, 1979, pp 193-197.
138. Squire, J.D. and Hughes, A.H. 1973
Evaluation of Agricultural Extension Work.
Occasional Paper No. 6, Dept. of Agricultural Economics and Farm Management, 1973.
139. Starke, J.S.; Smith, J.B. and Joubert, D.M. 1958
The Birthweight of Lambs.
S. Afr. Dept Agric. Tech. Serv. Sci. Bulletin, No. 382, 1958.
140. Stewart, D.E. 1979
Innovativeness and Communications: A Study of Behaviour and Attitudes among Farmers in Otago, New Zealand.
Ph.D. Thesis (unpubld) University of Otago - NZ.

141. Stoyanoff, N.J. and Fink, E.L. 1981
A Metric Multidimensional Scaling Analysis of
Cognitive Structure.
Paper presented to M.M.D.S. - Four at the Annual
Convention of International Communication Assoc.
in Minneapolis, Minnesota, May, 1981.
142. Sykes, A.R.; Griffiths, R.G. and Slee, J. 1976
Influence of Breed, Birthweight and Weather on the
Body Temperature of Newborn Lambs.
Anim. Prod. Vol. 22, 1976.
143. Thompson, K.F. 1983
Management of the Farm to Achieve Lamb Growth.
In. Lamb Growth Workshop Technical Handbook Animal
Industries Workshop, 1983, Lincoln College.
144. Torgerson, W.S. 1958
Theory and Methods of Scaling.
John Wiley and Sons Inc., N. York, 1958.
145. Tough, A. 1973
The Adults Learning Projects: A Fresh Approach to
Theory and Practice in Adult Learning.
Research in Education Series No. 1.
Ontario Inst. for studies in Education, 1973.
- 145(a) Triandis, H.L. 1971
Attitude and Attitude Change.
Toronto, John Wiley and Sons, Inc., 1971.
146. Treacher, T. 1983
Nutrient Requirements for Lactation in the Ewe.
Chapter 7 Sheep Production.
N. Haresign Butterworths, London, 1983.

147. Ulyatt, M.J.; Fennessey, P.F.; Rattray, P.V. and Jagusch, K.T.
The Nutritive Value of Supplements.
Chapter 5 in Supplementary Feeding Ed. by Drew, K.T. and Fennessey, P.F. NZ Soc. Anim. Prod - Occasional Publ. No. 7.
148. Underwood, C.A. and Salmon, P.W. 1980
Nature and Extent of Self Directed Learning in Agriculture.
School Agriculture and Forestry, University of Melbourne, 1980.
149. Walker, A.B. 1980
Beliefs, Attitudes and Extension.
Unpubl. Masterate Essay, Massey Univ. NZ, 1980.
150. Walker, A.B. 1984
Some Farm Management Implications of Export Hogget Production on Lower North Island Hill Country Sheep Farms.
Unpubl. M.Ag.Sc. Thesis Massey Univ. NZ, 1984.
151. Wallace, L.R. 1948
The Growth of Lambs before and after Birth in Relation to the Level of Nutrition.
J. Agric. Sci (Camb) Vol. 38, pt 2, 1948, pp 93.
152. Warren, G.F. 1912
An Agricultural Survey.
Cornell University Bulletin 295
Ithara, N.Y. 1912.
153. Warren, G.W. 1945
Forty Years of Farm Management Surveys.
Journal of Farm Economics, Vol. 27, 1945.

154. Warshaw, P.R. 1980
A New Model for Predicting Behavioural Intentions:
An alternative to Fishbein.
Journal of Marketing Research, May 1980. pp 153-172
155. Wicker, A.W. 1969
Attitude versus Actions: The Relationship of Verbal
and Overt Behavioural Responses to Attitudes; Objects.
Journal of Social Issues, Vol. XXV, Autumn 1969.
156. Woelfel, J.D. and Fink, E.L. 1980
The Measurement of Communication Process Galileo Theory
and Measurement.
N. York Academic Press (1980).
157. Woelfel, J.D.; Holmes, R.D.; Kincaid, D.L. and
Barnett, G.A. 1977
How to do a Galileo Study.
Good Books, Troy N.Y., 1977.
158. Woelfel, J.D. and Haller, A.O. 1971
Significant Others, The Self Reflexive Act and the
Attitude Formation Process.
American Sociological Review, Vol. 36, 1971, pp 74-87.
159. Woog, R.A. 1978
An Evaluation OF the Role of Extension in the Australian
Pig Industry.
University of Melbourne, School of Agriculture and
Forestry, 1978.
160. Woog, R.A. 1982
Agricultural Extension ... as I have experienced it.
Hawkesbury Agricultural College - a paper presented
to Advisory Services Division Workshop on extension
(mimeograph) 1982.

161. Wright, A.
Farm Management.
Undated Paper Dept. of Agric. Economics and Farm
Management, Massey University, NZ.

162. Young, G. and Householder, A.S. 1938
Discussion of a Set of Points in Terms of Mutual
Distances.
Psychometrika Vol. 3, 1938, pp 19-22.