

Copyright is owned by the Author of the thesis. Permission is given for a copy to be downloaded by an individual for the purpose of research and private study only. The thesis may not be reproduced elsewhere without the permission of the Author.

Milk separation and pasteurisation: the impact of separating temperature, and order of separation and pasteurisation, on the composition of skim milk, cream and separator sludge.

A thesis presented in partial fulfilment of the requirements for the degree of

Master of Food Technology

of Massey University, Palmerston North, New Zealand

Evonne Hilary Brooks

2014

Executive Summary

A principal purpose of the present study was to determine whether the order in which separation and pasteurisation of whole milk occurs has an effect on the composition of skim milk and cream, and thus potentially of products made using these streams. The study also sought to determine the effect of separating temperature on the composition and microbiological quality of skim milk and cream.

In addition, a survey of whole milks and separator sludges at four Fonterra manufacturing sites across New Zealand was carried out to determine whether there was regional variation in minerals content. This related to the suspected involvement of sludge minerals content in the incidence of desludging port erosion found in some separators, particularly in Northland.

Trials to study the effects of order of separation and pasteurisation, and of separating temperature, were first carried out in an ideal environment in the pilot plant at what is now Fonterra Research and Development Centre. Commercial-scale trials of the same kind were then carried out at Fonterra Kauri. The minerals survey was conducted by collecting and analysing whole milk and separator sludge samples collected at Fonterra Kauri, Fonterra Whareroa, Fonterra Glendebouye and Fonterra Edendale.

This study has identified that dairy manufacturing plants have a larger operating window in terms of separating temperature and equipment configuration than previously thought. The ANOVA analysis may have found significant effects, but the compositional changes were minor.

The mineral survey work showed that there were significant batch differences for all minerals. The calcium and phosphate contents explained most of the variability in the composition. The milk at the Kauri plant was different to milk in other parts of the country. Calcium content could be used to differentiate between the different sites tested. The phosphate content could be used to distinguish between separators.

Acknowledgements

Firstly, I would like to thank my Massey University supervisor, Dr Owen McCarthy. I would like to give him thanks for all the assistance and advice he has offered me throughout this project. This work would not have been possible without his support and encouragement.

Special thanks go to Penny Bilton and Jonathan Godfrey for their assistance with the statistical analysis work.

I would like also to thank the Foundation for Research, Science and Technology (FRST) and the Fonterra Group for providing the generous funding for this project.

I would like to express gratitude to Gwen Davies, Frank van de Ven and Kevin Palfreyman for supporting me from within Fonterra, providing me with information and aiding me in trials.

Many thanks to the following for providing testing and providing information on samples and analysis: Giao Truong (Milk Powder lab), Amy Yang (Milk Powder lab), Brenda Bowie (Milk Powder Lab), Errol Conaghan (Analytical Services Group), Sue Rowe (Micro), Dave Elgar (HPLC), Diane Sinclair (SDS PAGE) and Skelte Anema (SDS PAGE)

Thanks to the following technologists at the various sites for sampling the whole milk and sludges, and answering my questions: Carol Ma (Fonterra Kauri), Chris Maslin (Fonterra Clandeboye), Bill Pepper (Fonterra Whareroa), and Mark Casserly (Fonterra Edendale).

I would like to recognise the contribution that Rowan Hartigan made, in terms of providing me with information on the desludging port erosion of the separators at Fonterra Kauri.

I would like to show my appreciation to Gerhard Hoppe, Mike O'Connell, Bruce Duker, and Mike Leader for aiding me in the design and running of the pilot plant trials.

I cannot end without thanking my family, in particular my parents, on whose love, encouragement and unwavering support I have relied upon during the thesis writing process.

Table of contents

EXECUTIVE SUMMARY	I
ACKNOWLEDGEMENTS	II
1 INTRODUCTION	1
2 LITERATURE REVIEW	3
2.1 INTRODUCTION	3
2.2 MILK TREATMENT	3
2.2.1 <i>Pasteurisation</i>	3
2.2.2 <i>Separation</i>	4
2.2.3 <i>Standardisation</i>	6
2.2.4 <i>Order of separation and pasteurisation</i>	7
2.3 WHOLE MILK COMPOSITION	7
2.3.1 <i>Overall composition</i>	7
2.3.2 <i>Fat globules and their membranes</i>	10
2.3.3 <i>Salts</i>	11
2.3.4 <i>Corpora Amylacea</i>	13
2.3.5 <i>Effects of stage of lactation and time of year on milk composition</i>	13
2.4 EFFECTS OF PASTEURISATION ON MILK AND CREAM COMPONENTS	15
2.4.1 <i>Whole milk</i>	15
2.4.2 <i>Skim milk</i>	17
2.4.3 <i>Cream</i>	17
2.5 EFFECTS OF SEPARATING TEMPERATURE ON COMPOSITION OF SKIM MILK, CREAM, AND SLUDGE	17
2.6 EFFECTS OF ORDER OF PASTEURISATION AND SEPARATION ON COMPOSITION OF SKIM MILK, CREAM AND SLUDGE	19
2.7 SUMMARY	19
3 AIMS OF THE PROJECT	21
4 MATERIALS & METHODS	22
4.1 PILOT PLANT TRIALS	22
4.1.1 <i>Introduction</i>	22
4.1.2 <i>Raw Milk Source</i>	22
4.1.3 <i>Plant Configurations</i>	22
4.1.4 <i>Experimental Design</i>	23

4.1.5	<i>Sampling and Analyses</i>	24
4.2	FONTERRA KAURI TRIALS	28
4.2.1	<i>Introduction</i>	28
4.2.2	<i>Raw milk source</i>	28
4.2.3	<i>Plant configuration</i>	28
4.2.4	<i>Experimental Design for Kauri trials</i>	32
4.2.5	<i>Plant Operating Conditions</i>	32
4.2.6	<i>Sampling and Analyses</i>	32
4.3	MINERAL SURVEY TRIALS	36
4.4	DETAILS OF ANALYTICAL METHODS	40
4.5	STATISTICAL ANALYSIS	42
4.5.1	<i>Research questions addressed by the Pilot Plant and Kauri trials</i>	42
4.5.2	<i>Data collection in the Pilot Plant and Kauri trials</i>	42
4.5.3	<i>Statistical Analysis for the Pilot Plant trials</i>	42
4.5.4	<i>Statistical analysis for the Kauri trials</i>	43
4.5.5	<i>Interaction Plots</i>	44
4.5.6	<i>Percentage changes</i>	45
4.5.7	<i>Tukey HSD confidence intervals</i>	45
4.5.8	<i>Modelling of mineral survey trial results</i>	45
5	RESULTS	48
5.1	PILOT PLANT TRIALS	48
5.1.1	<i>Pilot Plant Whole Milk Results</i>	49
5.1.2	<i>Pilot Plant Skim Milk Results</i>	58
5.1.3	<i>Pilot Plant Cream Results</i>	67
5.1.4	<i>Pilot Plant Sludge Results</i>	75
5.2	PILOT PLANT TRIALS - GENERAL DISCUSSION AND CONCLUSIONS	93
5.2.1	<i>DAY (batch) effect: whole milk</i>	93
5.2.2	<i>DAY (batch) effect: skim milk, cream and sludge</i>	93
5.2.3	<i>Effect of pasteurisation: skim milk, cream and sludge</i>	93
5.2.4	<i>Effect of separating temperature</i>	94
5.2.5	<i>Effect of order of separation and pasteurisation</i>	95
5.3	FONTERRA KAURI TRIALS	96
5.3.1	<i>Fonterra Kauri Whole Milks</i>	96
5.3.2	<i>Fonterra Kauri Skim Milk</i>	111
5.3.3	<i>Fonterra Kauri Creams</i>	118
5.3.4	<i>Kauri Separator Sludges</i>	126

5.4	KAURI TRIALS – CONCLUSIONS AND COMPARISON WITH PILOT PLANT TRIALS	134
5.5	MINERAL SURVEY RESULTS	134
6	OVERALL DISCUSSION AND CONCLUSIONS, AND SUGGESTIONS FOR FUTURE WORK	141
7	REFERENCES	143
APPENDIX 1	PILOT PLANT TRIALS – WHOLE MILK – RAW DATA	146
APPENDIX 2	PILOT PLANT TRIALS – WHOLE MILK - ANOVA	146
APPENDIX 3	PILOT PLANT TRIALS – SKIM MILK – RAW DATA	146
APPENDIX 4	PILOT PLANT TRIALS – SKIM MILK - ANOVA	146
APPENDIX 5	PILOT PLANT TRIALS – CREAM – RAW DATA	146
APPENDIX 6	PILOT PLANT TRIALS – CREAM - ANOVA	146
APPENDIX 7	PILOT PLANT TRIALS – SLUDGE – RAW DATA	146
APPENDIX 8	PILOT PLANT TRIALS – SLUDGES - ANOVA	146
APPENDIX 9	PILOT PLANT TRIALS – SEPARATING EFFICIENCY CALCULATIONS	146
APPENDIX 10	FONTERRA KAURI TRIALS – WHOLE MILK – RAW DATA	147
APPENDIX 11	FONTERRA KAURI TRIALS – WHOLE MILKS - ANOVA	147
APPENDIX 12	FONTERRA KAURI TRIALS – SKIM MILK – RAW DATA	147
APPENDIX 13	FONTERRA KAURI TRIALS – SKIM MILK - ANOVA	147
APPENDIX 14	FONTERRA KAURI TRIALS – CREAM – RAW DATA	147
APPENDIX 15	FONTERRA KAURI TRIALS – CREAM - ANOVA	147
APPENDIX 16	FONTERRA KAURI TRIALS – SLUDGE – RAW DATA	147
APPENDIX 17	FONTERRA KAURI TRIALS – SLUDGE - ANOVA	147
APPENDIX 18	MINERAL SURVEY – WHOLE MILK – RAW DATA	147
APPENDIX 19	MINERAL SURVEY – SLUDGE – RAW DATA	148
APPENDIX 20	MINERAL SURVEY – SLUDGE - ANOVA	148
APPENDIX 21	MINERAL SURVEY – SLUDGE – INDIVIDUAL ANOVA ANALYSIS FOR CALCIUM AND PHOSPHATE CONTENT (NORMALISED BY SLUDGE TOTAL SOLIDS CONTENT)	148

Table of Equations

Equation 2-1 Sedimentation speed of a particle	4
Equation 2-2 Calculation of separation efficiency	6
Equation 2-3 Calculation of the C_0 parameter	15
Equation 4-1 Crude Protein content calculation from TN	40
Equation 4-2 True Protein content calculation from TN and NPN	40
Equation 4-3 Casein content calculation from TN and NCN	40
Equation 4-4 Whey Protein content calculation from NCN and NPN	40
Equation 5-1 Principal Component 1 (PC1)	137
Equation 5-2 Principal Component 2 (PC2)	137

Table of Figures

- Figure 4-1 Flow diagram of the P+S and S+P plant configurations. P = Pasteurisation; S = Separation. 23
- Figure 4-2 Diagram of the K1 (modified S+P) plant configuration 30
- Figure 4-3 Diagram of the K2 (P+S) plant configuration 31
- Figure 5-1 Interaction Plots for Pilot Plant whole milk. Figure continued on next page. 50
- Figure 5-2 Interaction Plots for Pilot Plant skim milk. Figure continued on next page. 60
- Figure 5-3 Interaction plots for Pilot Plant cream. Figure continued on next page. 70
- Figure 5-4 Interaction Plots for Pilot Plant sludge. Figure continued on next page. 77
- Figure 5-5 Tukey confidence interval plots for Pilot Plant sludge responses comparing DAY and TEMP effects. Figure continued on next page. 84
- Figure 5-6 Tukey confidence interval plots for Pilot Plant sludge responses showing TEMP effects. Figure continued on next page. 89
- Figure 5-7 Interaction plots for Fonterra Kauri whole milk. Figure continued on next page. 98
- Figure 5-8 Tukey plots for Fonterra Kauri whole milk. Figure continued on next page. 106
- Figure 5-9 Interaction Plots for Fonterra Kauri skim milk. Figure continued on next page. 112
- Figure 5-10 Interaction Plots for Fonterra Kauri cream. Figure continued on next page. 121
- Figure 5-11 Interaction Plots for Fonterra Kauri Sludge. Figure continued on next page. 127
- Figure 5-12 Principal components plot for separator sludge minerals composition. Individual separators are identified as *C300* and *C500* at Clandeboye, *Eden* at Edendale, *Kauri 1* and *Kauri 2* at Kauri, and *Whar* at Whareroa. Weeks 1 and 2 are identified by the numerals 1 and 2. 138
- Figure 5-13 Interaction Plot showing differences in sludge mineral content by separator 139

Table of Tables

Table 2-1 General composition of bovine milk (adapted from Walstra & Jenness, 1984)	7
Table 2-2 Whey protein composition of bovine milk (de Wit, 1998)	9
Table 2-3 Approximate salt composition of milk (Adapted from Walstra & Jenness, 1984)	11
Table 2-4 Distribution of milk salts between casein micelles and serum (Adapted from Walstra & Jenness, 1984)	11
Table 4-1 Experimental design for the Pilot Plant trials	24
Table 4-2 Analytical tests applied to the Pilot Plant S+P samples	26
Table 4-3 Analytical tests applied to the Pilot Plant P+S samples	27
Table 4-4 Experiment Design for the Fonterra Kauri trials	32
Table 4-5 Analytical tests applied to Fonterra Kauri S+P configuration samples	34
Table 4-6 Analytical tests applied to Fonterra Kauri P+S configuration samples	35
Table 4-7 Sampling Information for Mineral Survey trials	37
Table 4-8 Operating conditions of the separators tested.	38
Table 4-9 Reference Numbers of the Fonterra Analytical Services Group testing methods	41
Table 5-1 Summary table of ANOVA model p-values for Pilot Plant whole milk data	49
Table 5-2 Summary table of ANOVA model p-values for Pilot Plant skim milk data (Separating Temperature)	58
Table 5-3 Summary table of ANOVA model p-values for Pilot Plant skim milk data (Pasteurisation)	59
Table 5-4 Percentage changes in milk composition variables for Pilot Plant skim milk data	65
Table 5-5 Summary table of ANOVA model p-values for Pilot Plant cream data (TEMP)	68
Table 5-6 Summary table of ANOVA model p-values for Pilot Plant cream data (Pasteurisation)	69
Table 5-7 Percentage changes in milk composition variables for Pilot Plant cream data	73
Table 5-8 Summary table of ANOVA model p-values for Pilot Plant sludge data	76
Table 5-9 Percentage changes in milk composition variables for Pilot Plant sludge data	83

Table 5-10 Summary of ANOVA model p-values for Fonterra Kauri whole milk data	
	97
Table 5-11 Summary of ANOVA model p-values for Fonterra Kauri skim milk data	
	111
Table 5-12 Summary of ANOVA model p-values for Fonterra Kauri cream data	119
Table 5-13 Percentage changes in the milk compositional variables for the Fonterra Kauri cream data	119
Table 5-14 Summary of ANOVA model p-values for Fonterra Kauri sludge data	126
Table 5-15 Summary of ANOVA model p-values for analyses of sludge minerals	135
Table 5-16 Correlation coefficients for correlations between mineral content response variables	136
Table 5-17 Proportion of variability explained by each principal component	137
Table 5-18 Loadings for principal components	137

(Refer to Appendices on data cd)

Table A1-1 Raw data for the Pilot Plant whole milk	
Table A2-1 Non-casein nitrogen results - ANOVA of Pilot Plant whole milk data	
Table A2-2 Non-protein nitrogen results - ANOVA of Pilot Plant whole milk data	
Table A2-3 Fat content (MilkoScan) results - ANOVA of Pilot Plant whole milk data	
Table A2-4 Total solids content (MilkoScan) results - ANOVA of Pilot Plant whole milk data	
Table A2-5 Crude protein content (MilkoScan) results - ANOVA of Pilot Plant whole milk data	
Table A2-6 True protein content results - ANOVA of Pilot Plant whole milk data	
Table A2-7 Casein content results - ANOVA of Pilot Plant whole milk data	
Table A2-8 Whey protein content results - ANOVA of Pilot Plant whole milk data	
Table A2-9 Casein/whey protein ratio results - ANOVA of Pilot Plant whole milk data	
Table A2-10 pp5 (HPLC) results - ANOVA of Pilot Plant whole milk data	
Table A2-11 α -lactalbumin (HPLC) results - ANOVA of Pilot Plant whole milk data	
Table A2-12 Lactoferrin (HPLC) results - ANOVA of Pilot Plant whole milk data	
Table A2-13 BSA (HPLC) results - ANOVA of Pilot Plant whole milk data	
Table A2-14 β -lactoglobulin (HPLC) results - ANOVA of Pilot Plant whole milk data	
Table A2-15 Immunoglobulin G (HPLC) results - ANOVA of Pilot Plant whole milk data	
Table A2-16 Immunoglobulin G (ELISA) results - ANOVA of Pilot Plant whole milk data	
Table A2-17 Concentration (PSD) results - ANOVA of Pilot Plant whole milk data	

Table A2-18 Volume weighted mean diameter (PSD) results - ANOVA of Pilot Plant whole milk data

Table A2-19 Specific surface area (PSD) results - ANOVA of Pilot Plant whole milk data

Table A2-20 Span (PSD) results - ANOVA of Pilot Plant whole milk data

Table A2-21 Uniformity (PSD) results - ANOVA of Pilot Plant whole milk data

Table A2-22 Surface weighted mean diameter (PSD) results - ANOVA of Pilot Plant whole milk data

Table A2-23 d(0.1) (PSD) results - ANOVA of Pilot Plant whole milk data

Table A2-24 d(0.5) (PSD) results - ANOVA of Pilot Plant whole milk data

Table A2-25 d(0.9) (PSD) results - ANOVA of Pilot Plant whole milk data

Table A3-1 Raw data for the Pilot Plant skim milk

Table A4-1 Non-casein nitrogen results - ANOVA of Pilot Plant skim milk data

Table A4-2 Non-protein nitrogen results - ANOVA of Pilot Plant skim milk data

Table A4-3 Total nitrogen content results - ANOVA of Pilot Plant skim milk data

Table A4-4 Crude protein content results - ANOVA of Pilot Plant skim milk data

Table A4-5 True protein content results - ANOVA of Pilot Plant skim milk data

Table A4-6 Fat content (Roese-Gottlieb) results - ANOVA of Pilot Plant skim milk data

Table A4-7 Total solids content results - ANOVA of Pilot Plant skim milk data

Table A4-8 Casein content results - ANOVA of Pilot Plant skim milk data

Table A4-9 Whey protein content results - ANOVA of Pilot Plant skim milk data

Table A4-10 Casein/whey protein ratio results - ANOVA of Pilot Plant skim milk data

Table A4-11 Protein content (MilkoScan) results - ANOVA of Pilot Plant skim milk data

Table A4-12 Total solids content (MilkoScan) results - ANOVA of Pilot Plant skim milk data

Table A4-13 pp5 (HPLC) results - ANOVA of Pilot Plant skim milk data

Table A4-14 α -lactalbumin (HPLC) results - ANOVA of Pilot Plant skim milk data

Table A4-15 Lactoferrin (HPLC) results - ANOVA of Pilot Plant skim milk data

Table A4-16 BSA (HPLC) results - ANOVA of Pilot Plant skim milk data

Table A4-17 β -lactoglobulin (HPLC) results - ANOVA of Pilot Plant skim milk data

Table A4-18 Immunoglobulin G (HPLC) results - ANOVA of Pilot Plant skim milk data

Table A4-19 Immunoglobulin G (ELISA) results - ANOVA of Pilot Plant skim milk data

Table A5-1 Raw data for the Pilot Plant cream

Table A6-1 Crude protein content (MilkoScan) results - ANOVA of Pilot Plant cream data

Table A6-2 Fat content (MilkoScan) results - ANOVA of Pilot Plant cream data

Table A6-3 Total solids content (MilkoScan) results - ANOVA of Pilot Plant cream data

Table A6-4 Concentration (PSD) results - ANOVA of Pilot Plant cream data

Table A6-5 Volume weighted mean diameter (PSD) results - ANOVA of Pilot Plant cream data

Table A6-6 Specific surface area (PSD) results - ANOVA of Pilot Plant cream data

Table A6-7 Span (PSD) results - ANOVA of Pilot Plant cream data

Table A6-8 Uniformity (PSD) results - ANOVA of Pilot Plant cream data

Table A6-9 Surface weighted mean diameter (PSD) results - ANOVA of Pilot Plant cream data

Table A6-10 $d(0.1)$ (PSD) results - ANOVA of Pilot Plant cream data

Table A6-11 $d(0.5)$ (PSD) results - ANOVA of Pilot Plant cream data

Table A6-12 $d(0.9)$ (PSD) results - ANOVA of Pilot Plant cream data

Table A7-1 Raw data for the Pilot Plant sludge

Table A8-1 Non-casein nitrogen results - ANOVA of Pilot Plant sludge data

Table A8-2 Non-protein nitrogen results - ANOVA of Pilot Plant sludge data

Table A8-3 Total nitrogen content results - ANOVA of Pilot Plant sludge data

Table A8-4 Fat content (Roese-Gottlieb) results - ANOVA of Pilot Plant sludge data

Table A8-5 Total solids content results - ANOVA of Pilot Plant sludge data

Table A8-6 Crude protein content results - ANOVA of Pilot Plant sludge data

Table A8-7 True protein content results - ANOVA of Pilot Plant sludge data

Table A8-8 Casein content results - ANOVA of Pilot Plant sludge data

Table A8-9 Whey protein content results - ANOVA of Pilot Plant sludge data

Table A8-10 Casein/whey protein ratio results - ANOVA of Pilot Plant sludge data

Table A8-11 pp5 (HPLC) results - ANOVA of Pilot Plant sludge data

Table A8-12 α -lactalbumin (HPLC) results - ANOVA of Pilot Plant sludge data

Table A8-13 Lactoferrin (HPLC) results - ANOVA of Pilot Plant sludge data

Table A8-14 BSA (HPLC) results - ANOVA of Pilot Plant sludge data

Table A8-15 β -lactoglobulin (HPLC) results - ANOVA of Pilot Plant sludge data

Table A8-16 Immunoglobulin G (HPLC) results - ANOVA of Pilot Plant sludge data

Table A8-17 Calcium content results - ANOVA of Pilot Plant sludge data

Table A8-18 Potassium content results - ANOVA of Pilot Plant sludge data

Table A8-19 Magnesium content results - ANOVA of Pilot Plant sludge data

Table A8-20 Sodium content results - ANOVA of Pilot Plant sludge data

Table A8-21 Phosphorus content results - ANOVA of Pilot Plant sludge data

Table A8-22 Inorganic phosphorus present as phosphate results for ANOVA of Pilot Plant sludge data

Table A9-1 Separating efficiency calculation for the Pilot Plant trials

Table A10-1 Raw data for the Fonterra Kauri whole milk

Table A11-1 Non-casein nitrogen results - ANOVA of Fonterra Kauri whole milk data

Table A11-2 Non-protein nitrogen results - ANOVA of Fonterra Kauri whole milk data

Table A11-3 Protein content (MilkoScan) results - ANOVA of Fonterra Kauri whole milk data

Table A11-4 Fat content (MilkoScan) results - ANOVA of Fonterra Kauri whole milk data

Table A11-5 Total solids content (MilkoScan) results - ANOVA of Fonterra Kauri whole milk data

Table A11-6 Crude protein content (MilkoScan) results - ANOVA of Fonterra Kauri whole milk data

Table A11-7 True protein content results - ANOVA of Fonterra Kauri whole milk data

Table A11-8 Casein content results - ANOVA of Fonterra Kauri whole milk data

Table A11-9 Whey protein content results - ANOVA of Fonterra Kauri whole milk data

Table A11-10 Casein/whey protein ratio results - ANOVA of Fonterra Kauri whole milk data

Table A11-11 Calcium content results - ANOVA of Fonterra Kauri whole milk data

Table A11-12 Potassium content results - ANOVA of Fonterra Kauri whole milk data

Table A11-13 Magnesium content results - ANOVA of Fonterra Kauri whole milk data

Table A11-14 Sodium content results - ANOVA of Fonterra Kauri whole milk data

Table A11-15 Phosphorus content results for ANOVA of Fonterra Kauri whole milk data

Table A11-16 Inorganic phosphorus present as phosphate results - ANOVA of Fonterra Kauri whole milk data

Table A11-17 pp5 (HPLC) results - ANOVA of Fonterra Kauri whole milk data

Table A11-18 α -lactalbumin (HPLC) results - ANOVA of Fonterra Kauri whole milk data

Table A11-19 Lactoferrin (HPLC) results - ANOVA of Fonterra Kauri whole milk data

Table A11-20 BSA (HPLC) results - ANOVA of Fonterra Kauri whole milk data

Table A11-21 β -lactoglobulin (HPLC) results - ANOVA of Fonterra Kauri whole milk data

Table A11-22 Immunoglobulin G (HPLC) results - ANOVA of Fonterra Kauri whole milk data

Table A11-23 Concentration (PSD) results - ANOVA of Fonterra Kauri whole milk data

Table A11-24 Volume weighted mean diameter (PSD) results - ANOVA of Fonterra Kauri whole milk data

Table A11-25 Specific surface area (PSD) results - ANOVA of Fonterra Kauri whole milk data

Table A11-26 Span (PSD) results - ANOVA of Fonterra Kauri whole milk data

Table A11-27 Uniformity (PSD) results - ANOVA of Fonterra Kauri whole milk data

Table A11-28 Surface weighted mean diameter (PSD) results - ANOVA of Fonterra Kauri whole milk data

Table A11-29 d(0.1) (PSD) results - ANOVA of Fonterra Kauri whole milk data

Table A11-30 d(0.5) (PSD) results - ANOVA of Fonterra Kauri whole milk data

Table A11-31 d(0.9) (PSD) results - ANOVA of Fonterra Kauri whole milk data

Table A12-1 Raw data for the Fonterra Kauri skim milk

Table A13-1 Non-casein nitrogen results - ANOVA of Fonterra Kauri skim milk data

Table A13-2 Non-protein nitrogen results - ANOVA of Fonterra Kauri skim milk data

Table A13-3 Total nitrogen content results - ANOVA of Fonterra Kauri skim milk data

Table A13-4 Fat content (Roese-Gottlieb) results - ANOVA of Fonterra Kauri s skim milk data

Table A13-5 Total solids content results - ANOVA of Fonterra Kauri skim milk data

Table A13-6 Crude protein content results - ANOVA of Fonterra Kauri skim milk data

Table A13-7 True protein content results - ANOVA of Fonterra Kauri skim milk data

Table A13-8 Casein content results - ANOVA of Fonterra Kauri skim milk data

Table A13-9 Whey protein content results - ANOVA of Fonterra Kauri skim milk data

Table A13-10 Casein/whey protein ratio results - ANOVA of Fonterra Kauri skim milk data

Table A13-11 Calcium content results - ANOVA of Fonterra Kauri skim milk data

Table A13-12 Potassium content results - ANOVA of Fonterra Kauri skim milk data

Table A13-13 Magnesium content results - ANOVA of Fonterra Kauri skim milk data

Table A13-14 Sodium content results - ANOVA of Fonterra Kauri skim milk data

Table A13-15 Phosphorus content results - ANOVA of Fonterra Kauri skim milk data

Table A13-16 Inorganic phosphorus present as phosphate results - ANOVA of Fonterra Kauri skim milk data

Table A13-17 pp5 (HPLC) results - ANOVA of Fonterra Kauri skim milk data

Table A13-18 α -lactalbumin (HPLC) results - ANOVA of Fonterra Kauri skim milk data

Table A13-19 Lactoferrin (HPLC) results - ANOVA of Fonterra Kauri skim milk data

Table A13-20 BSA (HPLC) results - ANOVA of Fonterra Kauri skim milk data

Table A13-21 β -lactoglobulin (HPLC) results - ANOVA of Fonterra Kauri skim milk data

Table A13-22 Immunoglobulin G (HPLC) results - ANOVA of Fonterra Kauri skim milk data

Table A14-1 Raw data for the Fonterra Kauri cream

Table A15-1 Protein content (MilkoScan) results - ANOVA of Fonterra Kauri cream data

Table A15-2 Fat content (MilkoScan) results - ANOVA of Fonterra Kauri cream data

Table A15-3 Total solids content (MilkoScan) results - ANOVA of Fonterra Kauri cream data

Table A15-4 Concentration (PSD) results - ANOVA of Fonterra Kauri cream data

Table A15-5 Volume weighted mean diameter (PSD) results - ANOVA of Fonterra Kauri cream data

Table A15-6 Specific surface area (PSD) results - ANOVA of Fonterra Kauri cream data

Table A15-7 Span (PSD) results - ANOVA of Fonterra Kauri cream data

Table A15-8 Uniformity (PSD) results - ANOVA of Fonterra Kauri cream data

Table A15-9 Surface weighted mean diameter (PSD) results - ANOVA of Fonterra Kauri cream data

Table A15-10 d(0.1) (PSD) results - ANOVA of Fonterra Kauri cream data

Table A15-11 d(0.5) (PSD) results - ANOVA of Fonterra Kauri cream data

Table A15-12 d(0.9) (PSD) results - ANOVA of Fonterra Kauri cream data

Table A16-1 Raw data for the Fonterra Kauri sludge

Table A17-1 Non-casein nitrogen results - ANOVA of Fonterra Kauri sludge data

Table A17-2 Non-protein nitrogen results - ANOVA of Fonterra Kauri sludge data

Table A17-3 Total nitrogen content results - ANOVA of Fonterra Kauri sludge data

Table A17-4 Fat content (Roese-Gottlieb) results - ANOVA of Fonterra Kauri sludge data

Table A17-5 Total solids content results - ANOVA of Fonterra Kauri sludge data

Table A17-6 Crude protein content results - ANOVA of Fonterra Kauri sludge data

Table A17-7 True protein content results - ANOVA of Fonterra Kauri sludge data

Table A17-8 Casein content results - ANOVA of Fonterra Kauri sludge data

Table A17-9 Whey protein content results - ANOVA of Fonterra Kauri sludge data

Table A17-10 Casein/whey protein ratio results - ANOVA of Fonterra Kauri sludge data

Table A17-11 Calcium content results - ANOVA of Fonterra Kauri sludge data

Table A17-12 Potassium content results - ANOVA of Fonterra Kauri sludge data

Table A17-13 Magnesium content results - ANOVA of Fonterra Kauri sludge data

Table A17-14 Sodium content results - ANOVA of Fonterra Kauri sludge data

Table A17-15 Phosphorus content results - ANOVA of Fonterra Kauri sludge data

Table A17-16 Inorganic phosphorus present as phosphate results - ANOVA of Fonterra Kauri sludge data

Table A17-17 pp5 (HPLC) results - ANOVA of Fonterra Kauri sludge data

Table A17-18 α -lactalbumin (HPLC) results - ANOVA of Fonterra Kauri sludge data

Table A17-19 Lactoferrin (HPLC) results - ANOVA of Fonterra Kauri sludge data

Table A17-20 BSA (HPLC) results - ANOVA of Fonterra Kauri sludge data

Table A17-21 β -lactoglobulin (HPLC) results - ANOVA of Fonterra Kauri sludge data

Table A17-22 Immunoglobulin G (HPLC) results - ANOVA of Fonterra Kauri sludge data

Table A18-1 Raw data for the Mineral Survey whole milk

Table A19-1 Raw data for the Mineral Survey sludge

Table A20-1 Normalised calcium content results - ANOVA of Mineral Survey sludge data

Table A20-2 Normalised potassium content results - ANOVA of Mineral Survey sludge data

Table A20-3 Normalised magnesium content results - ANOVA of Mineral Survey sludge data

Table A20-4 Normalised sodium content results - ANOVA of Mineral Survey sludge data

Table A20-5 Normalised phosphorus content results - ANOVA of Mineral Survey sludge data

Table A20-6 Normalised inorganic phosphorus present as phosphate results - ANOVA of Mineral Survey sludge data

Table A21-1 Individual ANOVA analysis for normalised calcium content – Mineral Survey sludge data

Table A21-2 Individual ANOVA analysis for normalised phosphate content - Mineral Survey sludge data

1 Introduction

Two recent changes in milk treatment practice in Fonterra dairy processing plants have resulted, or might potentially result in, processing and product quality problems. The changes concern the centrifugal separation (S) of whole milk into skim milk and cream. Separation is an essential process step in the production of the composition-standardized whole milk required for making some dairy products, and in the manufacture of products made from skim milk and cream.

The first change is the order in which pasteurisation (P) and separation are carried out, from S+P (separation followed by pasteurisation) to P+S (pasteurisation followed by separation). This change is driven by the resulting saving in the capital and operating costs of pasteurisation plant, as two plants are required for S+P (one each for the skim milk and cream streams, or for the fat-standardized milk and excess cream streams), but only one for P+S.

New Zealand is currently the only country where P+S is now being used to a significant extent, and there are concerns about the potential impact of P+S on the processibility of skim milk, cream, and standardized whole milk streams. Separator manufacturers have expressed concern that separation in their machines may be affected adversely by prior pasteurisation of the whole milk.

The second change, which is also being applied in more and more Fonterra milk treatment plants, is the lowering of separating temperature. In some plants, the separating temperature has been reduced from the conventional level of about 55°C (warm separation, at which the maximum separating efficiency can be obtained without undue heat-induced product changes) to, typically, 45°C (cool separation). This change is driven by the need to control thermophile growth in separators and associated plant; the release of thermophile spores into process streams leads to downgrading of final products.

Pasteurisation and separation are ubiquitous and critical processing steps in the conversion of raw milk into export dairy products. The effects of the changes in the way these steps are applied, described above, on the characteristics of the resulting process streams (and ultimately of final products) need to be fully understood, in a fundamental way, and problems attributable to these changes solved. Failure to do this could have far reaching commercial consequences.

Compositional differences in whole milk composition across New Zealand also needed to be investigated. Erosion that has occurred of the sludge discharge ports on separators at some Fonterra sites is possibly due to regional variance in milk mineral content, and hence sludge mineral content.

2 Literature Review

2.1 Introduction

This literature review covers the milk treatment processing steps of separation, pasteurisation, and standardization. The order in which separation and pasteurisation have been carried out was also evaluated. The general composition of whole milk was researched. The impact of the milk treatment operations on milk composition was then assessed.

2.2 Milk Treatment

Separation, pasteurisation and standardization are ubiquitous process steps in the dairy industry. Separation is used to obtain skim milk and cream for further processing into a wide range of dairy products. Pasteurisation is a heat treatment that is used to make milk safe to drink by destroying pathogenic bacteria. Pasteurisation also extends the shelf life of the milk.

2.2.1 Pasteurisation

In the dairy industry, pasteurisation is normally achieved by continuous flow thermal processing. There are three steps in pasteurisation: heating, holding and cooling. The heating step raises the temperature of the milk or cream to a level that is lethal to the target micro-organism (*Coxiella burnetti*). The holding step 'holds' the flowing milk at a constant temperature for a certain period of time such that the concentration of this pathogen is reduced to a very low level. The cooling step then lowers the milk temperature as quickly as possible to minimise heat damage. The holding temperature-holding time combination is set using quantitative reaction kinetics data on the thermal death of the target micro-organism.

The pasteurisation process is designed to reduce the concentration of pathogenic bacteria to such a low value that the pasteurised product presents no risk to health, but the milk may contain thermoduric vegetative cells and spores that survive pasteurisation in significant proportions.

Legally required minimum heat treatments (temperature-time combinations) for use in pasteurisation are specified broadly in the *Animal Products (Dairy Processing*

Specifications) Notice 2006, issued pursuant to the *Animal Products Act 1999*. Details are given in *DPC3: Animal Products (Dairy): Approved Criteria for the Manufacturing of Dairy Material and Product*, issued pursuant to this notice.

They are as follows:

Batch holding method – 63°C for 30 minutes

HTST (High temperature short time continuous flow pasteurisation) – 72°C for 15 seconds

HHST (higher heat shorter time continuous flow pasteurisation) – 89°C for 1 second.

Other temperature-time combinations equivalent in lethal effect are permissible.

At the end of the heat treatment, and prior to further processing or storage, the whole milk must be immediately heated or cooled to a temperature that maintains the produce in a wholesome condition until further processing occurs, or for the duration of its shelf life (NZFSA D 121.1). HTST pasteurisation is now used almost universally in the New Zealand dairy industry.

A plate heat exchanger (PHE) is the core of an HTST pasteurizing plant. The PHE is an indirect continuous heat exchanger, which in the general case has regeneration, heating, cooling, and chilling sections. A chilling section might be unnecessary if the pasteurised product is to be sent forward to downstream processing, rather than to pasteurised product storage tanks.

2.2.2 Separation

The separation of whole milk is a vital process in a milk treatment plant, where whole milk is separated into cream and skim milk streams before further processing. The mechanical separators used in the dairy industry operate using the principle of centrifugal separation. Centrifugal separation occurs when a mixture of immiscible liquids, or of solids and liquids of different densities is subjected to centrifugal acceleration by rotation.

The sedimentation speed of a particle is described by Equation 2-1.

Equation 2-1 Sedimentation speed of a particle

$$v = \frac{d^2 (\rho_s - \rho_l) \omega^2 \cdot R}{18 \cdot \eta}$$

V = settling speed in centrifugal acceleration field (m s^{-1})

D = diameter of fat globule (m)

ρ_s = density of fat globule (kg m^{-3})

ρ_l = density of milk plasma (kg m^{-3})

η = dynamic viscosity ($\text{kg m}^{-1} \text{s}^{-1}$)

R = distance from axis of rotation (m)

ω = angular velocity (s^{-1})

Milk constituents that are denser than milk plasma (e.g., spores and somatic cells) are thrown outwards by the centrifugal effect, while fat globules are displaced inwards towards the axis of rotation of the centrifuge bowl.

The density difference between the fat and the milk plasma changes with temperature, going through a maximum at about 40°C . The dynamic viscosity of the milk decreases with increasing temperature. While the ratio of the two increases with temperature, the highest temperature that can be used for separation, taking into account fouling of the separator by the milk and heat damage to whey proteins, is about 55° (Westfalia Separator Food Tec, 2000)

The semi-open (paring disc) separator and hermetic (closed-bowl) separator are the two main types of centrifugal separators used in the dairy industry.

In a hermetic separator, the whole milk is pumped into the bowl from below, using an integral centrifugal pump, through a channel in the rotating bowl spindle.

In a paring disc separator, whole milk is gravity fed to the separator bowl at atmospheric pressure through a stationary axial inlet tube.

In order to allow continuous processing, self-desludging centrifugal separators are used. Solids are separated into the solids holding space after separation in the disc stack. The solids holding space is between the edge of the disc stack and the bowl wall and incorporates ejection ports. The ejection ports are opened and closed using a hydraulic sliding piston (false bowl base). The accumulated solids (sludge) is ejected instantaneously at preset intervals by a lowering of the sliding piston, whilst the separator is running on product.

The separator can be set to perform a partial or total ejection (a desludge), depending on the processing conditions. In the case of partial ejection, the product feed to the separator is not interrupted, and the bowl ejection ports are only opened briefly, so that only a pre-determined volume of solids is ejected. The liquid phase remains in the bowl during a partial ejection. In the case of total ejection (a full desludge), the ejection ports are fully opened, and stay open until the entire contents of the separator bowl have been ejected. The product feed to the separator is interrupted during a total ejection.

Separating Efficiency

The separating efficiency (E) of a separator is the proportion of the milk fat entering the separator in the whole milk that is recovered in the cream stream. The efficiency equation (Equation 2-2) is derived as a simplified version of the mass balance across the separator. The equation gives very accurate results owing to the large difference between the fat contents of the skim milk and whole milk.

Equation 2-2 Calculation of separation efficiency

$$E (\%) = (1 - (f_s/f_w)) \times 100$$

E = separating efficiency (%)

f_s = skim milk fat content (%)

f_w = whole milk fat content (%)

2.2.3 Standardisation

Standardisation of milk is the addition of ingredients into the milk stream in order to achieve a desired product composition.

Standardisation usually involves an on-line analyser that uses a Fourier Transform Infrared (FTIR) interferometer that scans the infrared absorption spectrum and calculates the composition of the stream, with dosing equipment to add cream and skim milk to raise or lower the fat, protein and lactose contents, respectively.

2.2.4 Order of separation and pasteurisation

There is very little information in the literature comparing the effect of order of separation and pasteurisation. A study was carried out by Foley & King (1977) on the influence of pasteurisation before and after separation on ripened cream butter properties. It was found that the copper level is a critical factor in the oxidative degradation of butterfat. In the raw whole milk, the greater proportion of the copper present was in the serum phase. The copper migrates to fat globules when whole milk or cream is heated. When the whole milk is heated, more copper ends up in the fat than when cream is heated, because of the greater serum/fat ratio in whole milk. As a result, there is more copper in cream after separation of pasteurised milk (P+S) than there is when cream is pasteurised after separation (S+P). Therefore S+P is better than P+S in terms of the oxidative stability of ripened cream butter.

2.3 Whole milk composition

2.3.1 Overall composition

The main components of milk are fat, proteins, lactose, minerals and water. The fat, lactose, proteins and minerals make up the majority of the approximately 13% total solids content of milk. The general composition of milk is shown in Table 2-1.

Table 2-1 General composition of bovine milk (adapted from Walstra & Jenness, 1984)

Component	Average level in whole milk (% w/w)
Water	87.3
Lactose	4.60
Fat	3.90
Protein	3.25
Casein	2.60
Whey Proteins	0.65
Mineral substances	0.65
Organic acids	0.18
Miscellaneous	0.14
Solids-not-fat	8.80

The fat of milk is primarily triacylglycerols (98%) which are present as an emulsion of fat globules stabilised by a complex membrane containing phospholipids, glycoprotein and other constituents. The minerals of milk occur either in solution or in association with the proteins, in the latter case as either undissolved salts or bound ions.

Proteins

There are two main categories of milk protein: caseins and whey proteins. Caseins correspond to approximately 80% of the total milk protein content, while the whey proteins represent approximately 20%.

Caseins

Caseins are proteins that are precipitated at 20°C from milk that has had its pH adjusted to 4.6. Bovine casein is composed of four separate proteins: α_{s1} - casein, α_{s2} - casein, β - casein, and κ - casein. Casein is very stable to high temperatures (Fox & McSweeney, 2003).

Casein Micelle Structure

Casein micelles are large colloidal particles made up of protein complexes as well as inorganic milk salts. Approximately 80 – 95% of the casein present in milk exists in the casein micelles. The micelles appear as relatively spherical particles, with a comparatively wide size distribution of 50 – 500 nm, with an average diameter of 150 nm (Phadungath, 2005). Casein micelle structure has not been fully elucidated.

Dissociation of Casein Micelles

The dissociation of caseins from the micelles can be caused by cooling, heating, pH adjustment, chelation of calcium, and treatment with urea and sodium dodecyl sulfate (SDS).

Whey Proteins

Table 2-2 displays the concentrations of the whey proteins in bovine milk.

Raw bovine whole milk contains about 0.7% whey protein. The major whey proteins are β -lactoglobulin (β -lg), α -lactalbumin (α -la), bovine serum albumin (BSA) and the immunoglobulins (Ig). The minor whey proteins include lactoferrin (Lf), the proteose peptones (PP), lactoperoxidases, lysozyme, lactollin, and many others. The whey proteins are relatively soluble and heat sensitive. The whey proteins become less soluble if the milk is heated (Walstra & Jenness, 1984). The shape of the whey proteins is globular to ellipsoid.

Table 2-2 Whey protein composition of bovine milk (de Wit, 1998)

Whey Protein	Concentration in bovine milk (g/L of milk)
Total Whey protein	6.30
Major	
Beta lactoglobulin (β -lg)	3.20
Alpha lactalbumin (α -la)	1.20
Bovine Serum Albumin (BSA)	0.40
Immunoglobulin G (IgG)	0.80
Bioactive	
Lactoferrin (LF)	0.20
Lactoperoxidase (LP)	0.03
Enzymes (>50)	0.03
Proteose peptones	<1

β -lactoglobulin (β -lg)

β -lactoglobulin is the whey protein present in the greatest amount, representing 50% of the total whey proteins and about 12% of the total protein in milk (Fox & McSweeney, 2003).

α -lactalbumin (α -la)

α -la accounts for around 25% of whey protein. α -la is a metalloprotein, as it binds one Ca^{2+} per molecule in a pocket containing four Asp residues. This calcium-containing protein is relatively heat stable, as the protein renatures following heat denaturation. Removal of the calcium reduces the heat stability of α -la; it then can be denatured at a low temperature, and does not renature on cooling (Fox & McSweeney, 2003).

Bovine serum albumin (BSA)

BSA represents approximately 5% of the whey proteins. The molecular weight of BSA is about 66 kDa and it contains 582 amino acid moieties. BSA is identical to the serum albumin found in the blood stream. In blood, BSA serves various functions, but in milk it is of little consequence. BSA binds metals and fatty acids. The ability of BSA to bind fatty acids may enable it to stimulate lipase activity (Fox & McSweeney, 2003).

Immunoglobulins (Ig)

The immunoglobulin fraction represents about 10% of the whey proteins. The physiological function of Ig is to deliver various types of immunity to the calf. Five types of immunoglobulins are found in bovine milk: IgM, IgA, IgD, IgE and IgG. These proteins are easily denatured by heat.

Proteose peptones (PP)

The proteose peptones are a group of whey proteins that remain soluble at pH 4.6 after heating at 95 – 100°C for 30 minutes, but are insoluble in 8-12% trichloroacetic acid. There are four groups of proteose peptones: PP-3, PP-5, PP-8-fast and PP-8-slow. This classification is based on electrophoretic mobility.

Lactoferrin (Lf)

Lactoferrin is an iron binding protein. Lactoferrin exists as a large single chain polypeptide with a molecular mass of 80 kDa, which is made up of approximately 670 – 690 amino acid moieties (Fox & McSweeney, 2003).

2.3.2 Fat globules and their membranes

Bovine milk contains 4 – 5% fat. More than 95% of the fat in bovine milk is secreted in the form of globules ranging in diameter 0.1 – 10 µm. A membrane, known as the milk fat globule membrane, envelops each milk fat globule. The milk fat globule membrane protects the fat against enzyme lipolysis and prevents the fat globules from flocculating and coalescing.

2.3.3 Salts

Salts are substances that are or can be present in milk as ions of fairly low molecular weight (Walstra & Jenness, 1984). The salts of milk are mainly the phosphates, citrates, chlorides, sulphates, carbonates, and bicarbonates of sodium, potassium, calcium, and magnesium (Fox & McSweeney, 1998). The most important salts of milk are listed in Table 2-3. The salt composition of bovine milk is not known precisely owing to the formation of ion pairs, such as the binding of Ca^{2+} and Mg^{2+} to citrate³⁻ (Walstra & Jenness, 1984). The milk salts are divided mainly between the colloidal and soluble phases, with a minor amount bound to the fat globules (Walstra & Jenness, 1984). The distribution of the major salts is shown in Table 2-4. The casein micelles contain undissolved calcium phosphate and a small amount of citrate. Ca^{2+} and Mg^{2+} are associated with the negatively charged proteins, as are small amounts of Cl^- (Walstra & Jenness, 1984).

Table 2-3 Approximate salt composition of milk (Adapted from Walstra & Jenness, 1984)

Cationic	mmol/kg	Anionic	mmol/kg
Sodium	17-28	Chloride	22-34
Potassium	31-43	Carbonate	~ 2
Calcium	26-32	Sulfate	~ 1
Magnesium	4-6	Phosphate	19-23
Amines	~ 1.5	Citrate	7-11
		Organic acids	~ 2
		Phosphoric esters	2-4

Table 2-4 Distribution of milk salts between casein micelles and serum (Adapted from Walstra & Jenness, 1984)

Compound	mg per 100 g whole milk	Percentage present in serum	mg per 100g serum	mg per g dry casein
Sodium	45	95	49	0.9
Potassium	143	94	145	3.3
Magnesium	11	66	8	1.5
Calcium	117	32	40	31
Inorganic phosphate	203	53	116	37
Citrate	175	92	173	5.6

Micellar Calcium Phosphate

Calcium and phosphate are present in excess of their solubilities in milk, but do not precipitate owing to interactions with casein in the casein micelles (Zhang & Aoki, 1996). The experimental evidence strongly favours the idea of colloidal calcium phosphate (CCP) being protected by a chemical association between the CCP and casein (Fox & McSweeney, 1998). X-ray diffraction work studying the native casein micelles did not reveal any evidence of an extensive crystal lattice (Holt, Hasnain & Hukins, 1982). The lack of the extensive crystal lattice has been construed as demonstrating an amorphous calcium phosphate (Holt, Hasnain, & Hukins, 1982). Holt (1995) suggests that CCP can be viewed as hydrated clusters of calcium and phosphate ions surrounded by casein phosphate clusters. X-ray absorption and infrared spectroscopy indicated that CCP most resembles brushite, $\text{CaHPO}_4 \cdot 2\text{H}_2\text{O}$ (Holt et al., 1982).

It has also been suggested that the X-ray diffraction evidence that indicates that calcium phosphate is amorphous can equally well be interpreted as evidence of small crystallite size, in agreement with the images obtained by electron microscopy (Holt et al., 1982).

The balance between the soluble and colloidal salts of milk is influenced by many factors, which can consequently modify the processing properties of milk. The solubility of calcium phosphate is highly temperature-dependent: it decreases with increasing temperature; therefore, heating causes precipitation of calcium phosphate while cooling increases the concentrations of soluble calcium and phosphate at the expense of CCP. The changes in the ionic balance are readily reversible, but after heating at high temperatures, reversibility becomes more sluggish and incomplete (Fox & McSweeney, 1998). It is for this reason that it has been hypothesised that the pasteurisation of whole milk prior to separation in the P+S configuration may cause the precipitation of calcium phosphate whilst the pasteurised milk is flowing through the regeneration (heat recovery) section of the heat exchanger (Gwen Davies, personal communication, 2005).

2.3.4 Corpora Amylacea

It was proposed that corpora amylacea could be causing the bowl erosion in the centrifugal separators that occurred at Fonterra Kauri, and other sites (Rowan Hartigan, personal communication, 2005).

Corpora amylacea are round or oval bodies found in the mammary glands of the cow and other large mammals (Brooker, 1978). Most of the research carried out on the corpora amylacea has used histochemical methods. The corpora amylacea are present in the tissue or milk of the cow during lactation, except in the colostrum of primiparous animals (Brooker, 1978; Reid, 1972). Very little information has been published on the levels of corpora amylacea in milk.

The corpora amylacea has fibrillar components that may be composed of amyloids (Brooker, 1978; Reid, 1972). The internal structure of the corpora amylacea is complex, and is made up of several distinct concentric layers. There are two types of corpora amylacea: a basophilic, dense, lamellate type, and a less dense, fibrillar type. The concentric stratifications and fine radial stripes of the dense corpora amylacea display different affinities for the stains used in histochemical studies (Sordillo & Nickerson, 1986). Inconsistent information on corpora amylacea composition, and their relation to lactation and mastitis have been reported (Brooker, 1978; Reid, 1972; Sordillo & Nickerson, 1986). Electron spectroscopy showed that the corpora amylacea contained around 12.3% calcium and 7.3% phosphorus (Claudon, Francin, Marchal, & Straczek, 1998).

2.3.5 Effects of stage of lactation and time of year on milk composition

Auld et al (1998) found in a New Zealand study that the stage of lactation and time of year were two of the main factors that affect the composition of whole milk ex farm. Using an experimental approach that enabled the effects of these two factors to be separated, they showed that some important manufacturing properties such as the protein:fat and casein:whey protein ratios were not significantly affected by stage of lactation, but were affected by time of year. The solid fat content was also affected by time of year.

Gray (1988), in another New Zealand study, reported and discussed the lactational trends in the composition of factory supply milk. As in New Zealand the lactation period of the national herd and the dairy season (August to May) are contemporaneous, period of lactation and time of year are confounded in the data presented by Gray. The data shows that the protein content, the fat content, and the protein:fat ratio fall initially and then increase to the end of lactation. The lactose content increases initially, remains fairly constant during most of the period of lactation, and then falls towards the end.

2.4 Effects of pasteurisation on milk and cream components

2.4.1 Whole milk

Protein denaturation is the unfolding of tertiary and secondary structures, without the breakage of covalent peptide bonds (Oldfield, 1996). Hydrogen bonding, Van der Waal's forces, and hydrophobic and electrostatic interactions maintain the globular structure of native whey proteins. If these forces are overcome by physical or chemical means, the protein unfolds into a random configuration, which exposes reactive side groups.

The unfolded protein can be transformed into an aggregated form via a separate irreversible step. The denatured whey proteins aggregate with other whey proteins or casein micelles by disulfide linkages, hydrophobic interactions, or calcium linking. The overall denaturation process of whey proteins can be viewed as a two-step process: denaturation and aggregation.

The extent of denaturation of the proteins is proportional to the intensity of the heat treatment applied (Morales, Romero, & Jimenez-Perez, 2000).

Thermal damage of raw whole milk during pasteurisation treatments was investigated by Lucisano et al (1994). Temperatures between 70 – 90 °C, and holding times of 12.2 – 178.6s were examined. A Co parameter (equivalent time) was used to express the chemical effect of the thermal treatments on the whole milk, and was calculated for each whey protein.

The Co value is estimated using Equation 2-3:

Equation 2-3 Calculation of the Co parameter

$$Co = \int d\theta / 10^{(t^* - t/z)}$$

θ = time

t^* = reference temperature (80 °C in this study)

t = temperature history

z = the temperature increase necessary for a ten times increase of the reaction rate

The thermal damage to heated whole milk was evaluated as the percentage of soluble whey proteins divided by the total proteins (SWP %). The individual whey proteins were detected by HPLC analysis, which measures only undenatured (still native) protein. The ratio between the sum of peak areas of the most thermally sensitive whey proteins (Ig₁, Ig₃ and BSA), and the total amount of β-Ig was used as a “denaturation index”. As the heat treatment became more severe, (longer holding times and higher temperatures), the SWP % decreases. There was a highly significant correlation between the SWP % values, and the “denaturation index” when the SWP % values were greater than or equal to 14%. At a temperature-time profile of 70 °C and 19.7 s, the percentage reduction in SWP was 19.68%. The relationship between each SWP % and Co value is highly significant for each whey protein. The percentage reduction in individual whey proteins in milk that is pasteurised in a plant with well-known temperature-time profiles can be predicted using Co (Lucisano et al, 1994). This kind of analysis is similar to the whey protein nitrogen index (WPNI).

Morales et al (1995) examined the characterization of industrial processed whole milk by analysing the heat-induced changes. The milk samples were subjected to thermisation, pasteurisation, direct ultra heat treatment (UHT), indirect UHT, and in-bottle sterilization. The pasteurisation conditions used were 85 °C for 30 s, and thus are more severe than typical HTST pasteurisation conditions. Denaturation of 60% for β-Ig, 17% for α-Ia, and 76% for BSA were found under this pasteurisation condition. Resmini et al (1989, cited by Morales et al (1995)) stated denaturation of 27% of β-Ig, 6% of α-Ia, and 42% of BSA for pasteurisation conditions of 85 °C for 15 s.

The order of increasing heat stability of whey proteins in whole milk, taking into account the irreversible changes, was reported as ALP < Lf < IgG < BSA < β-Ig < α-Ia by (Kulmyrzaev et al., 2005). It has been noted that there is a positive correlation between thermal denaturation and the molecular weight of the proteins (Lucisano, Pompei, Casiraghi, & Rizzo, 1994)

The HTST treatment at 72 °C for 15s would be expected to denature only 1% of the IgG, 2% of the IgA and 14% of the IgM (Mainer, Sanchez, Ena, & Calvo, 1997). Those results conflict with those of Li-Chan et al (1995) who found that the percentage retention of IgG after HTST pasteurisation ranged from 59% to 76%.

Sanchez et al (1992) reported that a pasteurisation treatment at 72°C to 74°C for 15s had no effect on the lactoferrin structure.

It was stated by Morales et al (2000) that thermisation, which is a less severe heat treatment than pasteurisation, causes denaturation of 11.8% of β -lg, 9.6% of α -la, and 30.7% of BSA.

2.4.2 Skim milk

Kessler and Beyer (1991) investigated the denaturation of whey proteins in skim milk with a casein/whey protein ratio of 83/17, whey with a casein/whey protein ratio of 0/100, and mixtures with casein/whey protein ratios of 60/40, 40/60 and 20/80. The samples were subjected to temperatures of 70 – 150°C, with holding times of up to 60 s. The results showed that there was no noticeable denaturation of β -lg under HTST pasteurisation conditions (72°C for 12s).

2.4.3 Cream

Studies investigating the effects of pasteurisation have focussed on whole milk or skim, as they have relatively large protein contents, when compared to cream.

2.5 Effects of separating temperature on composition of skim milk, cream, and sludge

The perceived optimum separating temperature range for separating whole milk into skim milk and cream is 45°C – 55°C. Temperatures above this range cause denaturation of whey proteins. Lower temperatures result in lower separating efficiencies.

Cold separation is carried out at temperatures of less than 10°C. The feed temperature for cold separation systems must be higher than 4°C, as the flow paths in the disc stack become blocked in a very short time owing to the high viscosity of the cream below this temperature (Westfalia Separator Food Tec, 2000). The high viscosity of the cream in cold separation also makes it impossible to produce a cream with a fat content greater than 42 % w/w. The efficiency in cold separation is considerably lower than in warm separation.

The separating temperature of two Westfalia MSE 600 separators were lowered from 55 °C to 46 °C at Fonterra Edendale in 2003 (Grant Johnstone, personal communication, 2005). The flow rate of 67.5 m³/hr was found to be the maximum achievable at the separating temperature of 46 °C, compared with the flow rate of 70 m³/hr used at the design temperature of 55 °C for the same separating efficiency. The milk treatment modules at Fonterra Edendale are set up as P+S, which usually restricts the temperature range achievable for the separator feed. Temperature control of the separator feed was achieved by using a bypass control valve over the heat regeneration section of the plate heat exchanger. A small flow of hot pasteurised whole milk could be made to bypass the regeneration section and be bled into the cooled milk to adjust the temperature over the 45 °C to 55 °C range. The aim of this work was to lower thermophile levels in the streams, and thus increase run times. The separation/pasteurisation of milk is a widely recognised source of thermophile contamination, particularly when milk treatment runs are excessively long.

King et al (1972) carried out a study on the effect of separation temperature on fat losses and on butter quality. This study examined the separating temperatures of 32 °C, 54.5 °C, 72 °C and 76.5 °C. The results showed that the fat loss in the skim milk was lowest (i.e. separating efficiency highest) when the milk was separated at 54.5 °C. The fat loss in the skim milk was highest (i.e. the separating efficiency lowest) when the milk was separated at 32 °C. The study showed that separating temperature had very little effect on the quality of butter.

A study was carried out that looked at the effect of separating temperature on the manufacture of Fritz butter (Kevin Palfreyman, 2005, personal communication). The separating temperatures tested in this investigation were 20 °C and 55 °C. It was found that the separating efficiency was lower at the separating temperature of 20 °C than at 55 °C. The buttermilk produced from the milk separated at 20 °C had a lower thermophile count than the buttermilk from the milk separated at 55 °C. The buttermilk produced from the milk separated at 20 °C had higher APC (aerobic plate count) than the buttermilk from the milk separated at 55 °C. Thus, cold separation results in a lower thermophile count, but a higher APC count than does warm separation. SDS-PAGE indicated a lower extent of protein denaturation and aggregation in the cold separated cream.

A study was carried out by Lewis (2003) to optimise separating temperatures used at the NZMP (now Fonterra) Te Awamutu and NZMP (now Fonterra) Hautapu sites. This study was carried out with a view to reducing thermophile growth during milk treatment, so that run times of downstream plant could be extended. The lowering of the separating temperature did not alter the APC or thermophilic spore counts in the skim and cream streams, or separating efficiency, at either site tested. There appeared to be a small change in the fat globule particle size distribution of the cream with the changing separating temperature.

The separating temperature was lowered from 53°C to 43°C at the Te Awamutu site. This did not affect thermophile numbers in the skim milk and cream streams.

A study was carried out by Chan (2005) to optimise the milk separation process at the Fonterra Kauri site. This study investigated the raw whole milk separators in the K1 milk treatment plant (separation followed by pasteurisation). Separating temperatures of 45°C, 40°C, 39°C, 37°C and 35°C were examined. The separating efficiency did not change significantly over the separating temperature range 39 to 45°C. However, it decreased at temperatures lower than 39°C. It was found that decreasing the separating temperature by 2 °C increased the fat content of the skim stream. A separating temperature of 39 °C resulted in reduced fat in the cream stream, and increased fat in the skim stream, when compared to the separators operating at the usual separating temperature of 45 °C. The run times of the trials at a given separating temperature were not sufficient to determine whether the separating temperature had an effect on thermophile levels in the skim and cream streams.

2.6 Effects of order of pasteurisation and separation on composition of skim milk, cream and sludge

There appears to be no information in the literature on the effects of order of pasteurisation and separation on the composition of skim milk, cream, and separator sludge.

2.7 Summary

There is a lack of detailed information on the effect of separating temperature on skim milk and cream composition. Very little information is available on the order in which

pasteurisation and separation are carried out, and therefore there is also no information on interactions between separating temperature and order.

No information is available on the composition of separator sludge and bowl erosion.

3 Aims of the project

The first aim of the project was to investigate the effects of the order of separation and pasteurisation, and of separating temperature, on the composition of the skim milk and cream under well-controlled pilot plant conditions. The whole milk, cream, skim and sludge streams were to be sampled to get an overall picture of what was happening. The minor protein composition of the whole milks, skim milks and sludges was of particular interest as this was where effects were expected to be noticed.

The second aim of the project was to replicate the pilot plant study at full factory scale under normal manufacturing conditions.

The third aim of the project was to carry out a survey of the mineral composition of whole milk and separator sludges across four sites. The goal was to determine whether there were significant regional differences, and whether these might be contributing to the separator bowl erosion problem being experienced at some sites.

4 Materials & Methods

4.1 Pilot Plant Trials

4.1.1 Introduction

A set of four one-day trials on the effects of order of pasteurisation and separation, and separating temperature, on process stream composition was carried out in the pilot plant at Fonterra Marketing and Innovation (now Fonterra Research and Development Centre) Palmerston North.

Two equipment configurations were tested in each trial. One configuration was pasteurisation of the raw milk followed by separation (P+S), and the other was separation of the raw milk followed by separate pasteurisation of the skim milk and cream streams (S+P). Four separating temperatures were investigated.

4.1.2 Raw Milk Source

Raw whole milk for each trial was collected by a tanker-trailer unit from the same small area of similar farms, and it was assumed that there were no significant differences between the tanker milk and the trailer milk. The milk was delivered to the Fonterra Marketing and Innovation site and stored in raw milk silos, from which it was drawn for the trials.

4.1.3 Plant Configurations

A flow diagram of the P+S and S+P plant configurations is displayed in Figure 4-1. In the diagram, P indicates the pasteurisation step, and S indicates the separation step.

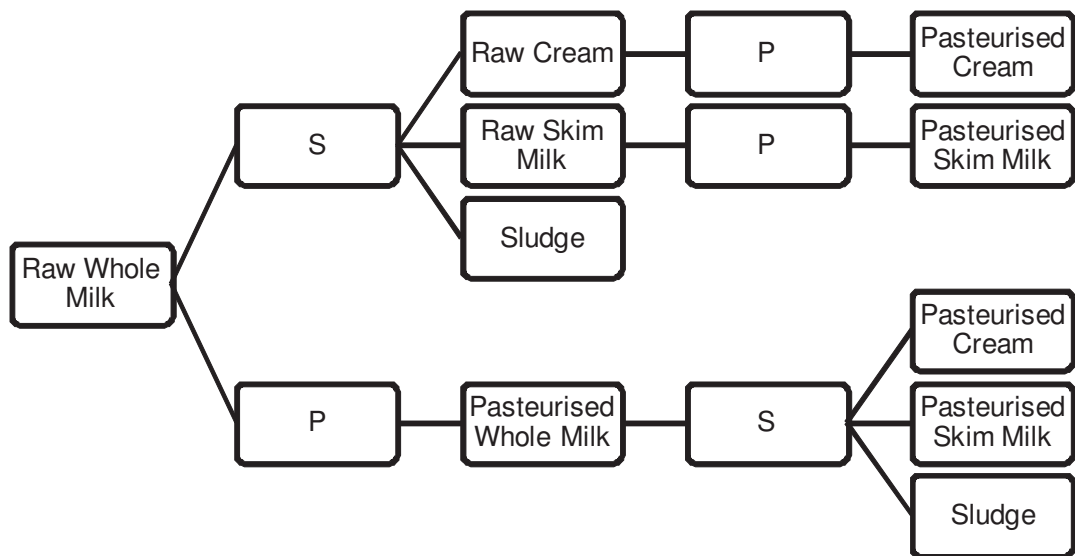

Figure 4-1 Flow diagram of the P+S and S+P plant configurations. P = Pasteurisation; S = Separation.

For each configuration, three different separating temperatures were investigated in each of the first three trials: 45 °C, 50 °C and 55 °C. In the fourth trial a separating temperature of 60 °C was used instead of 50 °C, as it was hypothesised, on the basis of the results obtained in trials 1-3, that this higher separating temperature would produce relatively greater effects when compared with 45 ° and 55 °C than the effects of 55 °C compared with those of 45 and 50 °C.

4.1.4 Experimental Design

The experimental design for the pilot plant trials is displayed in Table 4-1. The separating temperatures were investigated in random order within each plant configuration on each trial day.

On a given day, runs at the three separating temperatures were first carried out in the P+S configuration. The equipment was then cleaned in place (CIPed), and runs at the same three separating temperatures carried out in the S+P configuration. This order was used as, after P+S runs, only the plant downstream of the pasteuriser needed to be CIPed, whereas the whole plant, including the pasteuriser, would have needed CIPing had the S+P configuration been used first.

Table 4-1 Experimental design for the Pilot Plant trials

Day / Trial	Run	Equipment Configuration (Treatment)	Separating Temperature (°C)
1	1.1	P+S	50
1	1.2	P+S	45
1	1.3	P+S	55
1	1.4	S+P	55
1	1.5	S+P	50
1	1.6	S+P	45
2	2.1	P+S	55
2	2.2	P+S	45
2	2.3	P+S	50
2	2.4	S+P	45
2	2.5	S+P	50
2	2.6	S+P	55
3	3.1	P+S	55
3	3.2	P+S	45
3	3.3	P+S	50
3	3.4	S+P	50
3	3.5	S+P	45
3	3.6	S+P	55
4	4.1	P+S	55
4	4.2	P+S	60
4	4.3	P+S	45
4	4.4	S+P	45
4	4.5	S+P	55
4	4.6	S+P	60

4.1.5 Sampling and Analyses

The analyses that the samples from the S+P and P+S plant configurations were subjected to are displayed in Table 4-2 and Table 4-3, respectively. Details of the analytical methods are given in Table 4-9.

For the P+S configuration, samples were taken of raw whole milk, pasteurised whole milk, pasteurised skim milk, pasteurised cream and separator sludge. For the S+P configuration, samples were taken of raw whole milk, raw skim milk, raw cream, pasteurised skim milk, pasteurised cream and separator sludge. In each experimental run, when the plant had become stable at the set conditions, a set of samples was taken. The plant took approximately five minutes to become stable, once processing

conditions had been set. Each run lasted 30 minutes, with a separator desludge occurring at the end of each run.

Two samples were taken from each cream and skim milk sampling point during each run, the first after the plant had reached steady state running conditions, and the second ten minutes after the first. This was done to check that stable conditions had been achieved, and so that sufficient data would be available for statistical analysis.

The A or B in the sample descriptions in Table 4-2 and Table 4-3 denote the first or second sample, respectively, taken from that particular sample point during the run. The sample description "Sep" indicates that the sample was taken from a point after the separator, while the sample description "Past" denotes that the sample was taken from a point after the pasteuriser; for example, "Cream after Past B" indicates the second cream sample from that run, taken from a sample point after the pasteuriser.

Plant Operating Conditions

The whole milk flow rate for the trials was 6000 - 7000 kg/hr.

Table 4-2 Analytical tests applied to the Pilot Plant S+P samples

Plant Configuration	Sample Description	Roese-Gottlieb Fat Content	MilkoScan tests	Total Solids Content	Total Nitrogen Content	Non-Casein Nitrogen and Non-Protein Nitrogen content	IgG content (ELISA)	Minor protein composition (HPLC)	SDS PAGE	Milk fat globule particle size distribution	Microbiological testing
S+P	Raw whole milk		X			X	X	X	X	X	X
S+P	Skim after Sep A	X		X	X	X	X	X		X	X
S+P	Skim after Sep B	X		X	X	X	X	X	X	X	X
S+P	Cream after Sep A		X						X	X	X
S+P	Cream after Sep B		X						X	X	X
S+P	Skim after Past A	X		X	X	X	X	X		X	X
S+P	Skim after Past B	X		X	X	X	X	X	X	X	X
S+P	Cream after Past A		X							X	X
S+P	Cream after Past B		X						X	X	X
S+P	Separator Sludge	X		X	X	X	X	X	X	X	X

Table 4-3 Analytical tests applied to the Pilot Plant P+S samples

Plant Configuration	Sample Description	Röse-Gottlieb fat content	MilkoScan tests	Total Solids content	Total Nitrogen content	Non-Casein Nitrogen content and Non-Protein Nitrogen content	IgG content (ELISA)	Minor protein content (HPLC)	SDS PAGE	Milkfat globule particle size distribution	Microbiological testing
P+S	Raw whole milk		X			X	X	X	X	X	X
P+S	Past whole milk		X			X	X	X	X	X	X
P+S	Skim after Sep A	X		X	X	X	X	X		X	X
P+S	Skim after Sep B	X		X	X	X	X	X	X	X	X
P+S	Cream after Sep A		X							X	X
P+S	Cream after Sep B		X						X	X	X
P+S	Separator sludge	X		X	X	X	X	X		X	X

4.2 Fonterra Kauri Trials

4.2.1 Introduction

A set of four trials to investigate the effects on milk and cream composition of the order of separation and pasteurisation, and the effect of separating temperature, was carried out in a commercial milk treatment plant at Fonterra Kauri. The trials were conducted in the period 14 to 24 November 2005.

4.2.2 Raw milk source

The raw whole milk for the trials was taken from the normal site milk as available on the days of the trials.

4.2.3 Plant configuration

Two plant configurations were used in each trial (Figure 4-2 and Figure 4-3). In the first, K1 (S+P), separation of raw milk was followed by pasteurisation of the cream, while the skim milk was standardized, and then fed into an evaporator, where it was pasteurised during preheating (modified S+P). In the second, K2 (P+S), raw milk was pasteurised and then separated.

There were three separators (separators 1, 2 and 3) operating in parallel in the K1 (modified S+P) milk treatment plant (Figure 4-2). In the K1 configuration, the separating temperature was altered by adjusting the temperatures of the heat exchanger before the separator. If other separators in the K1 module were running during the trials, the separating temperatures used on those separators were the same as those used in normal operation.

The skim milks from these separators were combined in a balance tank, and the fat and protein contents were standardized (as this stream was used to produce skim milk powder). The creams from the three separators were combined in a balance tank and then pasteurised. The pasteurised cream was used either to standardize the skim milk, or to make butter or anhydrous milk fat (AMF). Separator 1 was selected for experimental work as it did not have the Westfalia proprietary PROPLUS modification of the separator bowl (designed to re-suspend partly separated solids in the outgoing skim milk). It had a desludging interval of 25 minutes. It was desired that a separator

without the PROPLUS modification be used for ease of comparison with the results from the pilot plant trials.

Two separators (separators 4 and 5) operated in parallel in K2 (Figure 4-3). Separator 5 was investigated as it did not have the PROPLUS modification of the separator bowl. Separator 5 had a desludging interval of 40 minutes.

Separator 1 (in K1) and Separator 5 (in K2) were Westfalia MSD 300 separators.

Three separating temperatures were investigated in K1 (S+P): 45, 50 and 55 °C. The temperatures were tested in random order within each trial, according to a statistical experimental design (Table 4-4). Only one temperature could be investigated in K2 (P+S), as the separating temperature in this configuration was governed by the fixed cooling effect in the regeneration section of the pasteuriser. In the pilot plant trials, this limitation did not exist, as flow rates could be changed to alter the amount of cooling in the regeneration section of the pasteuriser.

Unfortunately, because of the way the K1 and K2 plants were set up, it was not possible at Fonterra Kauri to exactly replicate the pilot plant trial conditions.

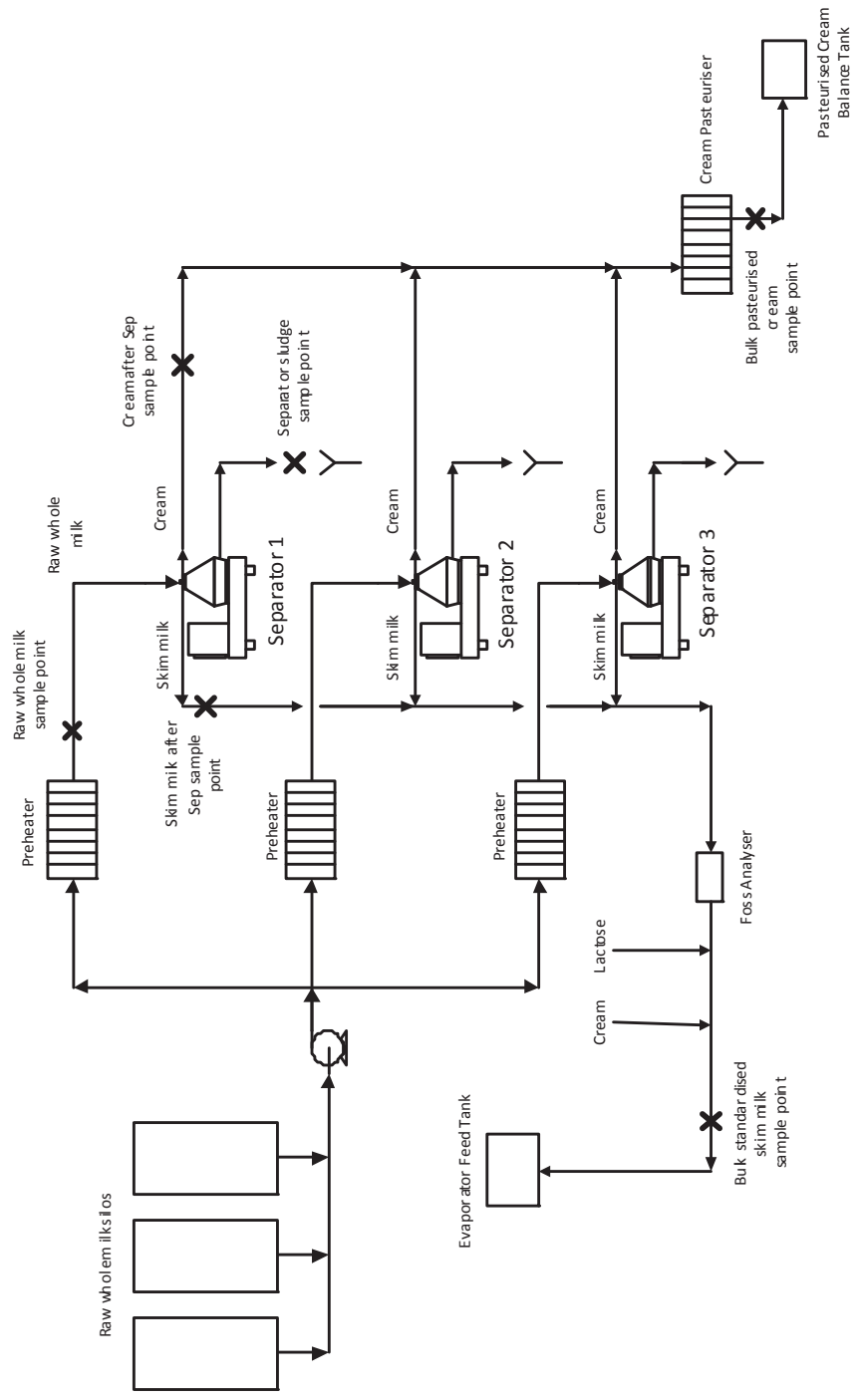

Figure 4-2 Diagram of the K1 (modified S+P) plant configuration

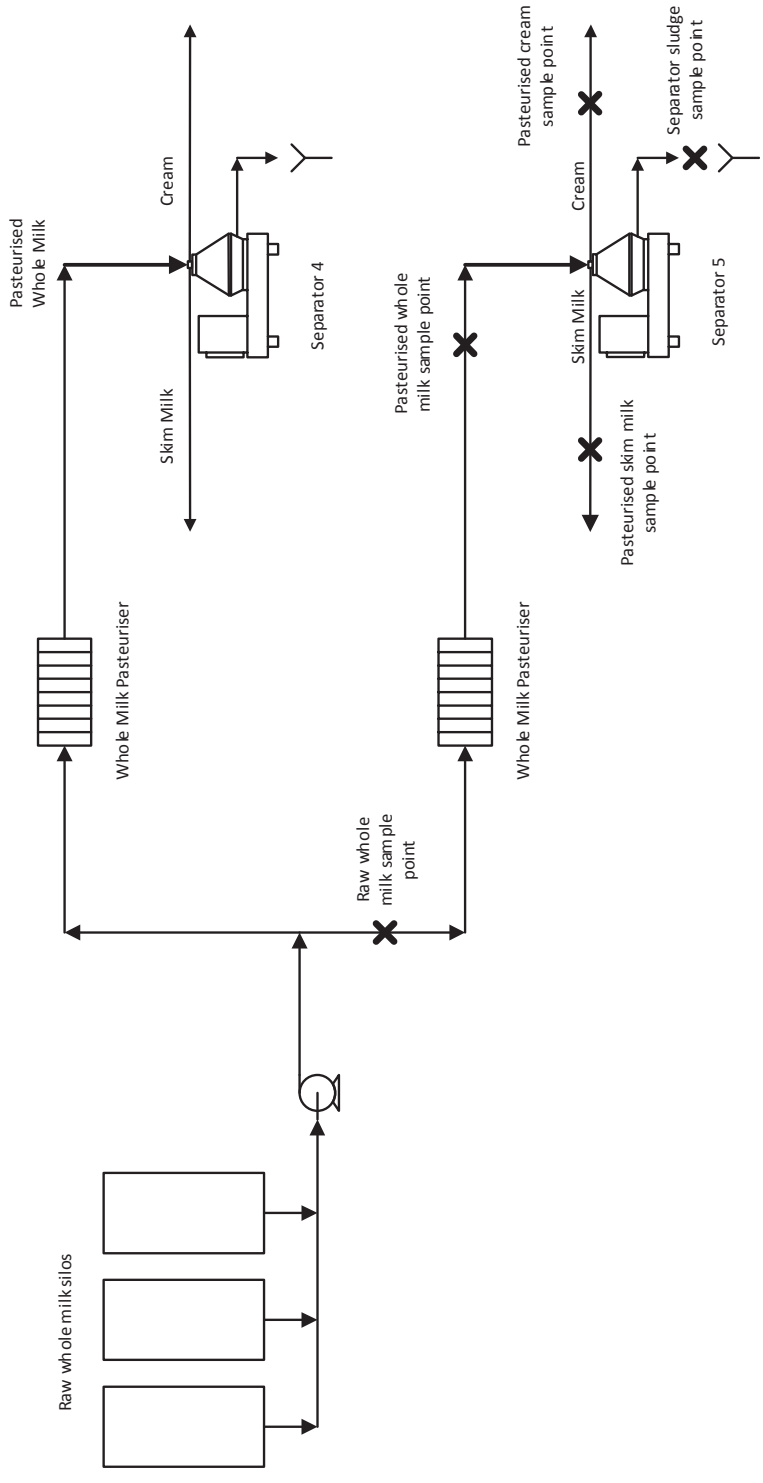

Figure 4-3 Diagram of the K2 (P+S) plant configuration

4.2.4 Experimental Design for Kauri trials

The experiment design for the Fonterra Kauri trials is displayed in Table 4-4. For K1 (modified S+P), separating temperatures were investigated in random order on a given trial day.

Table 4-4 Experiment Design for the Fonterra Kauri trials

Day (Trial)	Run	Equipment used	Equipment Configuration (Treatment)	Separating Temperature (°C)
1	1.1	K1	S+P	45
1	1.2	K1	S+P	50
1	1.3	K1	S+P	55
1	1.4	K2	P+S	50
2	2.1	K2	P+S	50
2	2.2	K1	S+P	45
2	2.3	K1	S+P	50
2	2.4	K1	S+P	55
3	3.1	K2	P+S	50
3	3.2	K1	S+P	50
3	3.3	K1	S+P	45
3	3.4	K1	S+P	55
4	4.1	K1	S+P	45
4	4.2	K1	S+P	55
4	4.3	K1	S+P	50
4	4.4	K2	P+S	50

4.2.5 Plant Operating Conditions

The flow rate through the separators was approximately 35 m³/hr for the K1 and K2 configurations.

The whole milk pasteurising temperature (K2) used for the K2 configuration was 80 °C.

The bulk cream pasteurising temperature (K1) was 80 °C.

4.2.6 Sampling and Analyses

Table 4-5 and Table 4-6 show the analytical tests that the samples from the K1 (S+P) and K2 (P+S) configurations, respectively, were subjected to. Details of the analytical methods used are given in Section 4.2.6.

Samples of the following were taken from the K1 (S+P) plant during each run: raw whole milk, raw skim milk ex Separator 1, raw cream ex Separator 1, sludge from Separator 1, raw standardised bulk skim milk, and pasteurised bulk cream. The pasteurised bulk cream contained cream from separators 2 and 3 of the K1 configuration, as well as the cream from separator 1. The raw standardized bulk skim milk contained skim milk from separators 2 and 3 as well as from separator 1 and had had its protein and fat contents standardized.

Samples of the following were taken from the K2 (P+S) configuration: raw whole milk, pasteurised whole milk, pasteurised skim from separator 5, pasteurised cream from separator 5, and sludge from separator 5.

Two samples (A and B) were taken from each cream and skim milk sampling point during each run, the first after the plant had reached steady state running conditions, and the second ten minutes after the first. This was done to check that stable conditions had been achieved, and so that sufficient data would be available for statistical analysis.

It was not possible to obtain samples of pasteurised skim milk from the K1 (S+P) plant, as the skim milk was pasteurised in the preheater of the evaporator and there was no sample point installed.

Table 4-5 Analytical tests applied to Fonterra Kauri S+P configuration samples

Config.	Sample Description	Roese-Gottlieb fat content	MilkoScan tests (Protein, fat and total solids content)	Total solids content	Total nitrogen content	Non-Casein Nitrogen content	Mineral Analysis	Minor protein content (HPLC)	Milk fat globule particle size distribution	Microbiological testing
S+P	Raw whole milk		X			X	X	X	X	X
S+P	Skim after Sep A	X		X	X	X	X	X		X
S+P	Skim after Sep B	X		X	X	X	X	X	X	X
S+P	Cream after Sep A		X							X
S+P	Cream after Sep B		X						X	X
S+P	Bulk Standardized Skim A	X		X	X	X		X		X
S+P	Bulk Standardized Skim B	X		X	X	X	X	X	X	X
S+P	Bulk Cream after Past A		X							X
S+P	Bulk Cream after Past B		X						X	X
S+P	Separator Sludge	X		X	X	X	X	X		X

Table 4-6 Analytical tests applied to Fonterra Kauri P+S configuration samples

Config.	Sample Description	Röse-Gottlieb fat content	MilkoScan tests (Protein, fat and total solids content)	Total solids content	Total nitrogen content	Non-Casein Nitrogen content and Non-Protein Nitrogen content	Mineral Analysis	Minor protein content (HPLC)	Milkfat globule particle size distribution	Microbiological testing
P+S	Raw whole milk		X		X	X	X	X	X	X
P+S	Past whole milk		X			X	X	X	X	X
P+S	Skim after Sep A	X		X		X	X	X	X	X
P+S	Skim after Sep B	X		X	X	X	X	X	X	X
P+S	Cream after Sep A		X						X	X
P+S	Cream after Sep B		X						X	X
P+S	Separator Sludge	X		X	X	X	X	X		

4.3 Mineral Survey Trials

Problems had arisen in some sites in Northland due to corrosion of the desludging ports of the milk separators. Since this problem was not occurring consistently in all milk processing plants, it was postulated that the level of corrosion in a particular separator might be related to the minerals content of the sludge produced. A study was conducted to determine whether sludge minerals content varied significantly with region across New Zealand, in order to provide data that could potentially be used to further understand the corrosion problem.

A set of trials was carried out to investigate the regional variation in New Zealand of the mineral content of raw whole milk and separator sludge. The study design consisted of sample collection from two North Island and two South Island sites, three times a day, on one specific day in each of two consecutive weeks, followed by appropriate analyses.

Samples of whole milk and sludge were taken at Fonterra Kauri, Fonterra Whareroa, Fonterra Clandeboye and Fonterra Edendale sites in an attempt to gain a New Zealand-wide picture (Table 4-7). At the Edendale and Whareroa sites, measurements were taken from a single separator. Samples of the whole milk separator feed were taken concurrently with samples of sludge, to determine whether the variation in sludge composition was simply due to variation in the composition of the whole milk entering the separator.

Information on the processing conditions for each separator tested is displayed in Table 4-8. The sampling times for the second week of sampling were not recorded for the Fonterra Kauri and Fonterra Clandeboye sites.

Table 4-7 Sampling Information for Mineral Survey trials

Site	Site Sep	Date	Week	Time	Sample
Kauri	Kauri K1 MSD300	6-Mar-2006	1	14:34	1
	Kauri K1 MSD300	6-Mar-2006	1	17:05	2
	Kauri K1 MSD300	6-Mar-2006	1	20:01	3
	Kauri K1 MSD300	10-Mar-06	2		4
	Kauri K1 MSD300	10-Mar-06	2		5
	Kauri K1 MSD300	10-Mar-06	2		6
Kauri	Kauri K2 MSD300	10-Mar-06	2	8:30	1
	Kauri K2 MSD300	10-Mar-06	2	12:00	2
	Kauri K2 MSD300	10-Mar-06	2	16:00	3
	Kauri K2 MSD300	10-Mar-06	2		4
	Kauri K2 MSD300	10-Mar-06	2		5
Whareroa	Whareroa Tetra 918	7-Mar-2006	1	11:30	1
	Whareroa Tetra 918	7-Mar-2006	1	13:30	2
	Whareroa Tetra 918	7-Mar-2006	1	17:00	3
	Whareroa Tetra 918	14-Mar-2006	2	14:00	4
	Whareroa Tetra 918	14-Mar-2006	2	16:30	5
	Whareroa Tetra 918	14-Mar-2006	2	17:45	6
Clandeboye	Clandeboye MSE500	6-Mar-2006	1	8:30	1
	Clandeboye MSE500	6-Mar-2006	1	12:00	2
	Clandeboye MSE500	6-Mar-2006	1	16:00	3
	Clandeboye MSE500	13-Mar-2006	2		4
	Clandeboye MSE500	13-Mar-2006	2		5
	Clandeboye MSE500	13-Mar-2006	2		6
Clandeboye	Clandeboye MSE300	6-Mar-2006	1	8:30	1
	Clandeboye MSE300	6-Mar-2006	1	12:00	2
	Clandeboye MSE300	6-Mar-2006	1	16:00	3
	Clandeboye MSE300	13-Mar-2006	2		4
	Clandeboye MSE300	13-Mar-2006	2		5
	Clandeboye MSE300	13-Mar-2006	2		6
Edendale	Edendale Tetra 918	6-Mar-2006	1	9:30	1
	Edendale Tetra 918	6-Mar-2006	1	13:20	2
	Edendale Tetra 918	6-Mar-2006	1	17:15	3
	Edendale Tetra 918	13-Mar-2006	2	10:00	4
	Edendale Tetra 918	13-Mar-2006	2	13:20	5
	Edendale Tetra 918	13-Mar-2006	2	16:20	6

Table 4-8 Operating conditions of the separators tested.

Site	Separator	Equipment configuration	Feed Type	Desludging interval (minutes)	Separator throughput (m ³ .hr ⁻¹)	Separating Temp. (°C)	Separator Speed (rpm)	Sludge mass per desludge (kg) including hood flush water	Sludge mass per desludge (kg) without hood flush water
Kauri K1	Westfalia MSD 300	S+P	Raw whole milk	25	38	46	4800		
Kauri K2	Westfalia MSD 300	P+S	Pasteurized whole milk	40	35	50	4800	15	
Whareroa	Tetra 918 (Sep 2/3)	S+P	Raw whole milk	15	62	46		19.42	13.2
Clandeboye	Westfalia MSE 500	P+S	Pasteurized whole milk	25	55 - 60	46	4800	20.2	
Clandeboye	Westfalia MSE 300	P+S	Pasteurized whole milk	26	40	46	4800	27.4	
Edendale	Tetra 918 (Sep 5)	P+S	Pasteurized whole milk	25	70	48	2030	24.34	13.93

Owing to the large sample numbers (and consequent pressure on Fonterra analytical facilities), the sampling was carried out over two weeks. Three samples of raw whole milk and three samples of sludge from each separator were taken at each site on 6th/7th March 2006. A second set of samples was taken on the 10th/13th March. For the Whareroa site, the second set of samples was taken on the 14th March. The teams collecting the samples at each site were instructed to take the raw whole milk and separator sludge samples at times spaced out over the run/day. Recorded sampling times are shown in Table 4-7.

The (refrigerated) samples were sent to Fonterra Marketing & Innovation in Palmerston North by courier for sample analysis by the Analytical Services Group (ASG). Raw whole milk samples were subjected to the following analyses: MilkoScan fat content, MilkoScan protein content, MilkoScan total solids content, and mineral analysis (calcium, potassium, magnesium, sodium, total phosphorus, and inorganic P as PO₄). Separator sludge samples were analysed for: total solids content and minerals (calcium, potassium, magnesium, sodium, total phosphorus, and inorganic P as PO₄). Of particular interest were the levels of calcium and phosphate, as calcium phosphate is insoluble and is a major constituent of casein micelles.

Some of the separator sludge samples were also analysed for total nitrogen content, non-protein nitrogen content and non-casein nitrogen content. The first and third samples from each separator on each day tested were selected for these measurements. The analyses were not carried out on all the separator sludge samples collected in order to save money.

The mass of sludge ejected in a separator desludge was measured, where possible, so that the absolute masses of milk components lost to separator sludge could be calculated. The sludge mass was measured for desludges that occurred both with and without the hood flush water. The hood flush water of the separator is important as it affects the composition (dilution) of the separator sludge.

4.4 Details of Analytical Methods

The analyses to which particular types of samples were subjected are shown in Table 4-2, Table 4-3, Table 4-5 and Table 4-6.

Samples were sent to the Analytical Services Group (ASG) at Fonterra Marketing and Innovation for the standard analyses shown in Table 4-9.

The Roese-Gottlieb fat content test was performed on samples with low expected fat contents, and is a solvent extraction method. The total solids content method is based on oven drying a known mass of sample for a fixed time, and calculating the total solids content on the basis of the measured mass loss. The Foss MilkoScan uses Fourier transform infra-red analysis (FTIR), which involves detecting the absorbance of infra-red radiation by the sample.

Total nitrogen, non-casein nitrogen (NCN), and non-protein nitrogen (NPN) contents were determined using the Kjeldahl method. The crude protein, true protein, casein and whey protein contents were calculated from the total nitrogen (TN), the NCN and the NPN values using Equation 4-1- Equation 4-4.

Equation 4-1 Crude Protein content calculation from TN

$$\text{Crude Protein content (\% w/w)} = (\text{TN}) \times 6.38$$

Equation 4-2 True Protein content calculation from TN and NPN

$$\text{True Protein content (\% w/w)} = (\text{TN} - \text{NPN}) \times 6.38$$

Equation 4-3 Casein content calculation from TN and NCN

$$\text{Casein content (\% w/w)} = (\text{TN} - \text{NCN}) \times 6.38$$

Equation 4-4 Whey Protein content calculation from NCN and NPN

$$\text{Whey Protein content (\% w/w)} = (\text{NCN} - \text{NPN}) \times 6.38$$

Minerals (calcium, potassium, etc) were assayed using inductively coupled plasma-optical emission spectroscopy (ICP-OES).

The Milk Powder Laboratory at Fonterra Marketing and Innovation tested samples for milk fat globule particle size distribution. The milk fat globule particle size distribution was measured using a Malvern Mastersizer.

HPLC was used to obtain a profile of the undenatured (still native) minor proteins in the samples. This analysis could not be performed on the cream samples as the fat content of the cream was too high.

Samples were sent to the Microbiological Services Group (MSG) at Fonterra Marketing and Innovation for the following microbiological analyses: thermophile count, thermoduric count, APC (aerobic plate count), and coliform count.

Table 4-9 Reference Numbers of the Fonterra Analytical Services Group testing methods

Tests	Laboratory Method Number	Reference Standard
Roese-Gottlieb fat content	ACCA_004	NZTM: 3.6.3 (2001)
Total Solids content	ACCA_010	NZTM: 12.15.1 (1994)
MilkoScan tests (Protein, Fat and Total Solids content)	ACCA_046	FT120 Operators Manual
Total Nitrogen content (liquid)	ACCA_053	NZTM: 3.15.4 (2001)
Non-Protein Nitrogen (NPN) content, Non-Casein Nitrogen (NCN) content	ACCA_053	NZTM: 3.15.3 (2000) IDF Std: 20-2 (2001) IDF Std: 20-4 (2001)
Immunoglobulin G (IgG) content (ELISA)	N/A	Bethyl Bovine IgG ELISA Quantitation Kit. Catalog No. E10-118
Inorganic Phosphorus present as phosphate (PO ₄) content	ACAA_001	ChemLab Instruments Ltd - Method Sheet: CP2-075-10 (1979)
ICP OES tests (Calcium, Potassium, Magnesium, Sodium and Phosphorus contents)	ACTE_025	NZTM: 3.9.21 (draft)

4.5 Statistical Analysis

4.5.1 Research questions addressed by the Pilot Plant and Kauri trials

The main research questions were as follows:

- Does the order of application of centrifugal separation and pasteurisation affect the composition and particle size distribution of skim milk and cream?
- Is there any effect of separation temperature on these attributes?

4.5.2 Data collection in the Pilot Plant and Kauri trials

In each set of trials, four batches of milk were tested over 4 days (blocks). Each batch of raw milk was passed through the P+S and S+P configurations at different separation temperatures. Samples were taken of raw and pasteurised whole milk, skim milk and cream, and in the case of the S+P configuration, of raw skim milk and raw cream as well. Measurements were made of a number of composition and other variables. These response variables measured fell into three clusters covering general chemical composition, minor proteins, and particle size distribution (PSD). The final products from both configurations were pasteurised skim milk and pasteurised cream.

4.5.3 Statistical Analysis for the Pilot Plant trials

The ANOVA modelling technique was used since it separates out the variability in a measured response at each level of a given factor (e.g. at three different separation temperatures) and uses these variabilities to test for differences between the mean values (one for each temperature) of the response. A significant difference between means indicates that the factor (separating temperature) had a significant effect on that response.

A significant effect is indicated by a p-value greater than 0.05.

The batches of milk (on different days) provided a blocking factor, which allowed differences in batches of milk to be identified. Inter-batch variation needed to be accounted for before any effects could be ascertained.

Inside each block two treatment factors were applied:

- Order of pasteurisation and separation
- Separation temperature

The pilot plant experiment had a split plot design. Within each main plot, DAY (representing different batches of milk), were three treatment subplots, the process treatments of S+P (raw), S+P (past) and P+S (past). These treatments were recoded to give two orthogonal (independent) factors ORDER and PAST.

Within each treatment subplot were different separation temperatures, 45°C, 50°C, 55°C and 60°C. The latter temperature was used only on the 4th trial day, and was therefore confounded with Day 4, i.e. the effect of the temperature 60°C could not be distinguished from effects due to the fourth batch of milk.

For each combination of process and temperature, two separate sub-samples, A and B, were taken of the skim milk and cream process streams to ensure consistency of measurement. The repeated measurements determined the design as a split-plot.

Analysis of the raw whole milk was useful in investigating the effect of pasteurisation. Models for the skim milk and cream components examined the effects of pasteurisation, the order in which separation and pasteurisation were carried out and separation temperature, and the effects of interactions between main factors.

As no sub-samples were taken of separator sludge, the analysis reverted to an unbalanced randomized block design, with factors of pasteurisation, separation temperature and interactions. The treatments were S+P (raw) and P+S (past), and thus the treatment effect was pasteurisation.

4.5.4 Statistical analysis for the Kauri trials

The limitations, from the experimental point of view, of the Kauri plants K1 and K2, required the following approaches:

- The S+P configuration had three separating temperatures, whilst the P+S arrangement had only one separating temperature, 50°C. The effect of separating temperature was therefore dependent upon the configuration used. In particular, the effects of the temperatures 45°C and 55°C could not be

differentiated from the effect of the S+P configuration. The temperature variable was thus nested in the ORDER variables for the modelling.

- In the S+P plant configuration, measurements on the separated products skim milk and cream were taken only from Separator 1, whereas measurements on pasteurised cream, the combined flow from separators 1 – 3 (Figure 4-2) were taken from post the bulk pasteuriser. Thus for the cream component, the effect of pasteurisation was indistinguishable from the effect of Separator 1.
- Skim milk in the S+P configuration was not pasteurised but instead subjected to a process of standardisation, in which it was supplemented with lactose and cream. The effect of pasteurisation on skim milk was determined by a comparison between raw skim milk in the S+P configuration and pasteurised skim milk in the P+S configuration. A process effect could not be measured for skim milk.
- There was inconsistency in the amount of data collected for each cluster of response variables. The problems included a lack of sub-sampling, the use of only two separating temperatures, not all separating temperatures represented on all days, and measurements taken over two batches instead of four. Consequently, several models were required to examine the effects of batch, temperature and plant arrangement for different clusters across the various milk components.

4.5.5 Interaction Plots

The ANOVA models indicated significant effects. The interaction plots showed the direction of those effects, i.e. whether there was an increase or decrease in the milk composition factor. An absolute difference is shown by the lines not intersecting. A cross-over pattern in the plot indicates that the change is not absolute, i.e. it cannot be determined whether it is an increasing or decreasing effect.

The effect of the variable ORDER is represented by the change between S+P (past), the dashed line, and P+S (past), the dotted line. The effect of the factor PAST is the difference between S+P (raw), the solid line, and the average of S+P (past) and P+S (past).

4.5.6 Percentage changes

The percentage changes compare the change in composition from raw product to pasteurised product, or from the S+P to the P+S configuration. Some changes were large but insignificant, since the significance of a percentage change is dependent upon the amount of random variability in the response variable concerned (shown by the Residuals Sum Sq in ANOVA outputs).

4.5.7 Tukey HSD confidence intervals

For a significant factor (e.g. DAY), these confidence intervals display where the differences were, e.g. which particular days differed from each other. The Tukey HSD plot comprises pairwise confidence intervals to compare each factor level against every other factor level. The plot for DAY compares differences between each pair of batches, Days 1 – 2, 1 – 3, etc. A significant pairwise difference is indicated by its associated confidence interval not crossing the dashed line in the plot at the value zero. This means that zero is not included in the confidence interval for differences, so the difference is not zero, and therefore the difference is significant.

4.5.8 Modelling of mineral survey trial results

The modelling utilized analysis of variance on response variables representing the content levels of minerals within the sludge. Since differences in the incoming whole milk were expected across the four plants, the model included predictor variables *BySite* and *ByWeek* to represent the four different sites and the two consecutive weeks.

A third predictor, *Batch*, comprising the interaction between site and day, equated to a different batch for each site on each day, and captured the differences not explained by the main effects representing location and time, i.e. differences between plants and between weeks. The significances of differences across the four individual plants and between the two weeks were investigated using a split-plot ANOVA model. The data were split into “plots” designated by the Batch variable, i.e. each plot comprised measurements taken at a given plant in a given week.

A fourth predictor variable, *Separator*, was included in the model to represent the various separators employed across disparate sites. Since measurements at the

Edendale and Whareroa plants were taken from a single separator in each case, this predictor variable explained differences between the Kauri and Clandeboye sites only. The overall differences between batches and the effect of separators at disparate plants were analysed using a nested (non-split) ANOVA model comprising only *Batch* and *Separator* as predictors of mineral concentrations. The nested aspect of the model arises because each separator is associated with only one plant.

Assumptions applied to the modelling were firstly that there was a different batch of milk for each time point, i.e. per site per day. Secondly, it was assumed that the same batch of milk at a given time point passed through both separators at the Kauri and Clandeboye plants. Since measurements were taken at different times of the day on the various sites, the predictor *Batch* was a random variable, and is used as the error term in the model in the split-plot component of the analysis.

The relationship between whole milk composition and sludge composition was investigated by including a covariate in the model. For a given response variable, the covariate comprised the corresponding measurements made on the whole milk. For example, calcium measurements for the whole milk were used as the covariate when sludge calcium was the response variable in the model. Thus whole milk was used as a reference for changes in sludge composition. This allowed changes in sludge calcium caused solely by changes in whole milk calcium to be allowed for in the statistical analysis.

The original measurements of mineral composition in the sludge were normalised by dividing by the total solids content of the sludge. This procedure eliminated differences in sludge mineral composition due to variation in the total solids content of the sludge.

A principal components analysis was also performed on the variables representing the mineral content of the sludge, since these variables were found to be highly correlated. Principal component terms are linear combinations of the mineral responses, and are constructed to be statistically independent (orthogonal). The object of principal component analysis is to reduce the dimensions of the dataset when correlation of variables exists, since correlated variables are providing similar information. The principal components capture interrelationships between predictor variables, and can reveal underlying factors which describe the structure in the dataset.

An interaction plot was also constructed to compare content levels of the different minerals in the sludge for individual separators.

5 Results

The results are discussed in the following order: Pilot Plant trials, Fonterra Kauri trials, minerals survey.

5.1 Pilot Plant Trials

The pilot plant trial results are discussed in the following order: whole milk, skim milk, cream, separator sludge.

The A and B samples taken (as described in Section 4.1.5) showed very good replication and therefore averaged values were analysed statistically.

5.1.1 Pilot Plant Whole Milk Results

Raw analytical data are tabulated in Appendix 1. The ANOVA outputs for the PP whole milks are displayed in Appendix 2.

p-values for the effects of DAY (= raw milk batch) and PASTEURISATION are shown in Table 5-1.

Table 5-1 Summary table of ANOVA model p-values for Pilot Plant whole milk data

Signif. codes: 0 '*', 0.001 '**', 0.01 '*', 0.05 '.', 0.1 ' ' 1**

Response	Day	Pasteurization
Chemical		
NCN	0.00765 **	----
NPN	----	----
MSCAN_FAT	----	----
MSCAN_TS	----	----
CRUDE_PROT	0.001098 **	----
TRUE_PROT	0.0003252 ***	----
CASEIN	0.04403 *	----
WHEY_PROT	----	----
C.WP_RATIO	----	----
Minor Proteins		
HPLC_pp5	0.007417 **	----
HPLC_ALA	2.488e-05 ***	----
HPLC_Lf	0.0004453 ***	----
HPLC_BSA	0.02331 *	----
HPLC_BLG	0.003378 **	----
HPLC_IgG	0.03983 *	----
ELISA_IgG	----	----
PSD variables		
PSD_Conc	----	----
PSD_VWMD	0.03035 *	----
PSD_SSA	----	----
PSD_Span	----	----
PSD_Unif	----	----
PSD_SWMD	----	----
PSD_D(0.1)	----	----
PSD_D(0.5)	0.04622 *	----
PSD_D(0.9)	0.02260 *	----

Plots showing the interactions of DAY, PASTEURISATION and order of P and S are shown in Figure 5-1. The corresponding ANOVA tables are shown in Appendix 2 (on cd). It is noted that since the whole milk was separated upstream of pasteurisation in the S+P configuration, but was pasteurised prior to separation in the P+S configuration, the configuration treatment was actually pasteurisation.

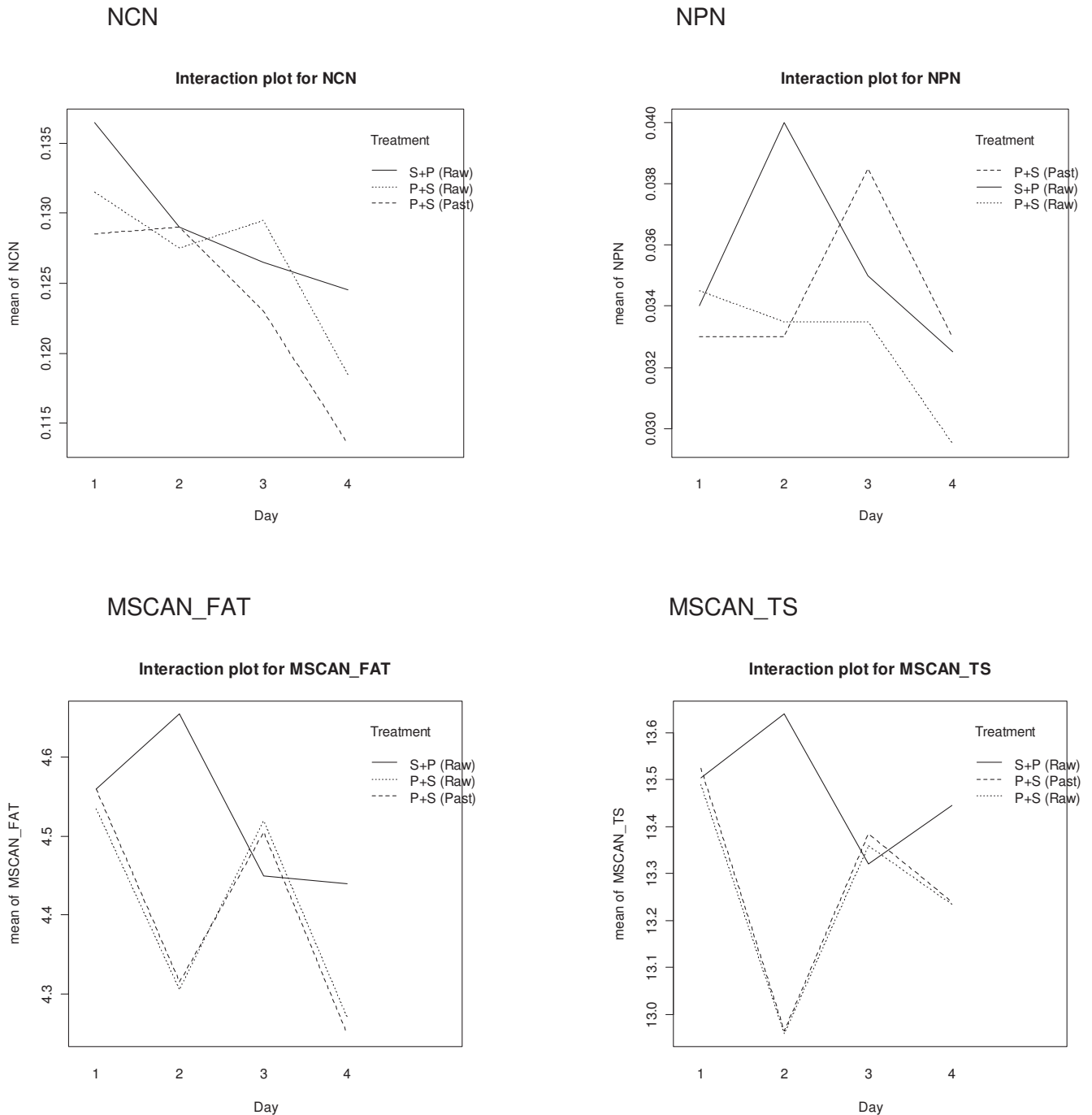
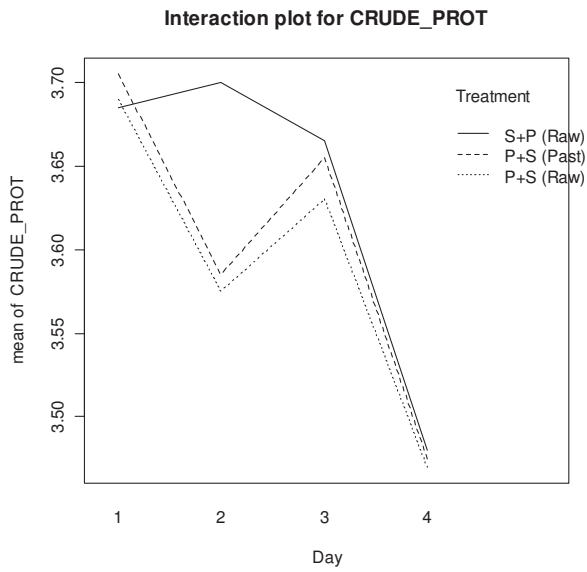
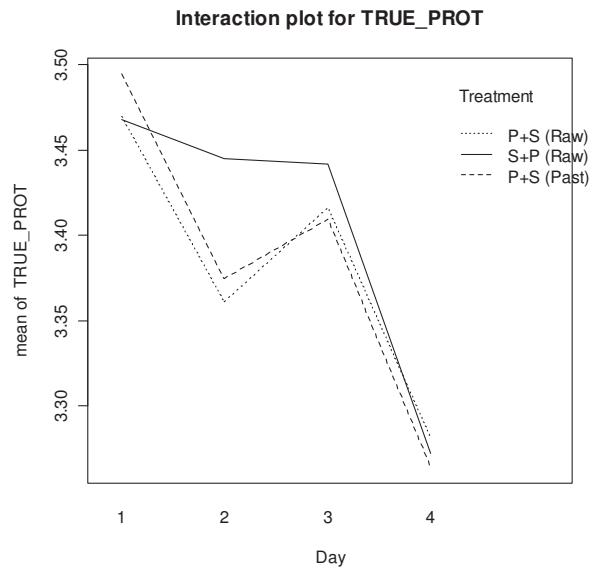

Figure 5-1 Interaction Plots for Pilot Plant whole milk. Figure continued on next page.

CRUDE_PROT (MSCAN_PROT)



TRUE_PROT



CASEIN

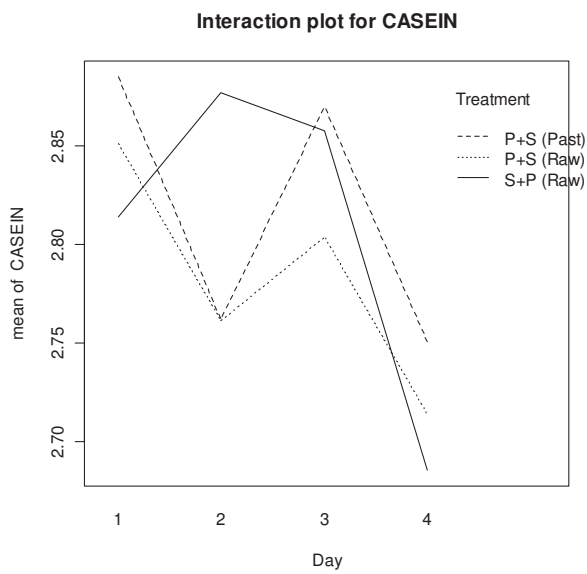

WHEY_PROT

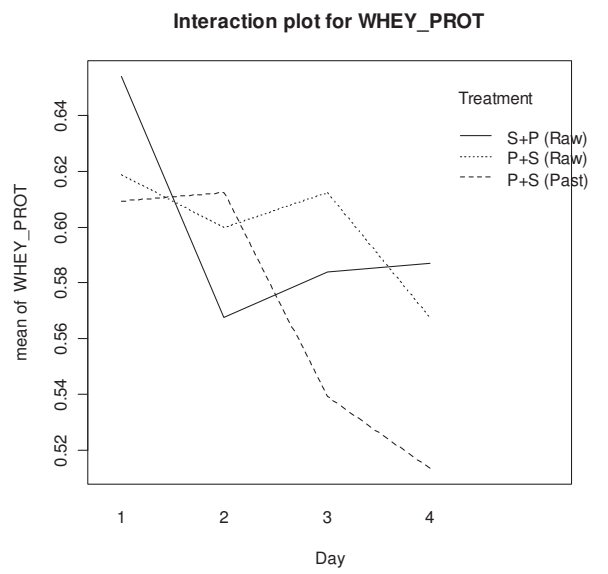
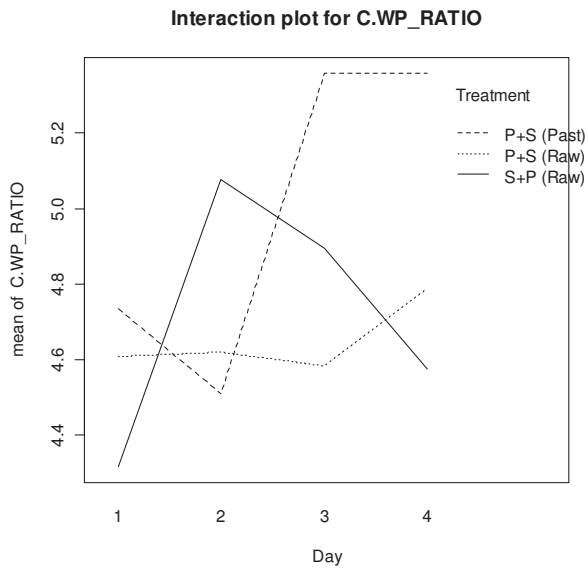

Figure 5-1 continued. Figure continued on next page.

C.WP_RATIO



MINOR PROTEINS

HPLC_pp5

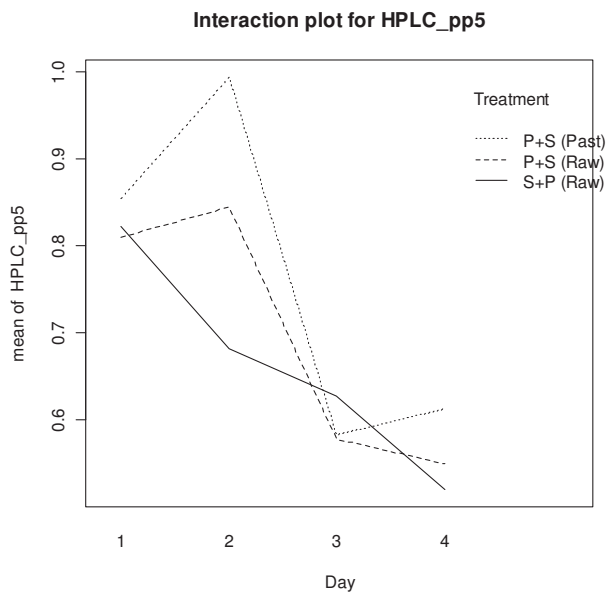

HPLC_ALA

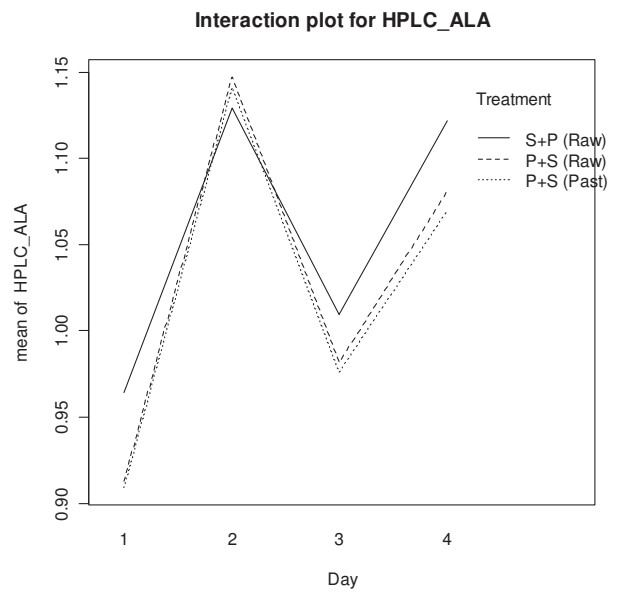
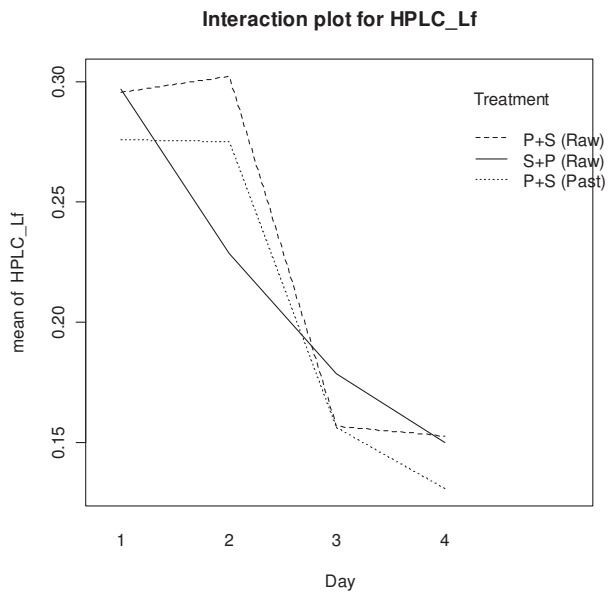
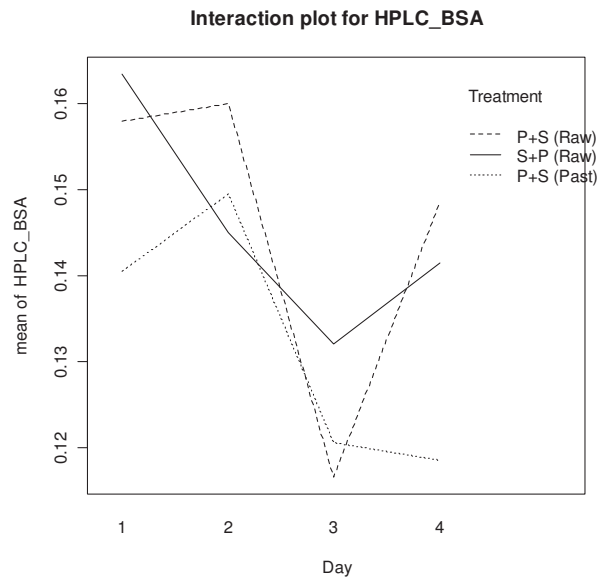

Figure 5-1 continued. Figure continued on next page.

HPLC_Lf



HPLC_BSA



HPLC_BLG

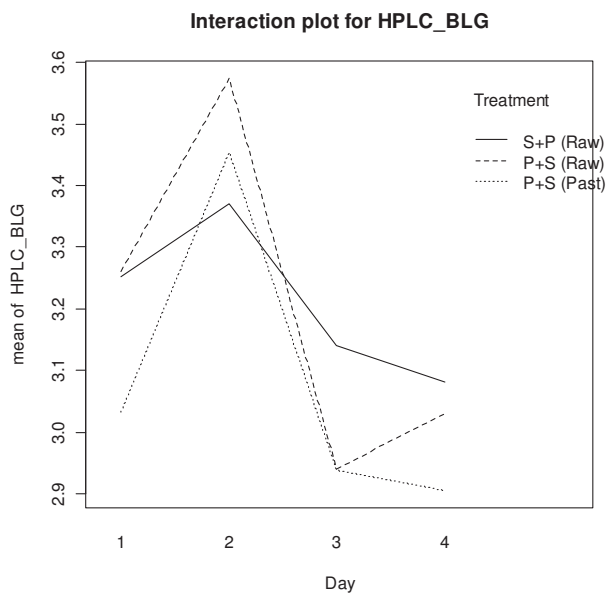

HPLC_IgG

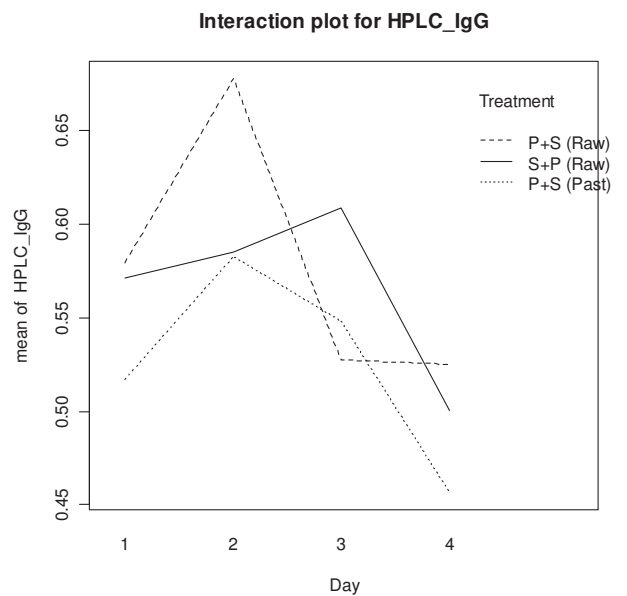
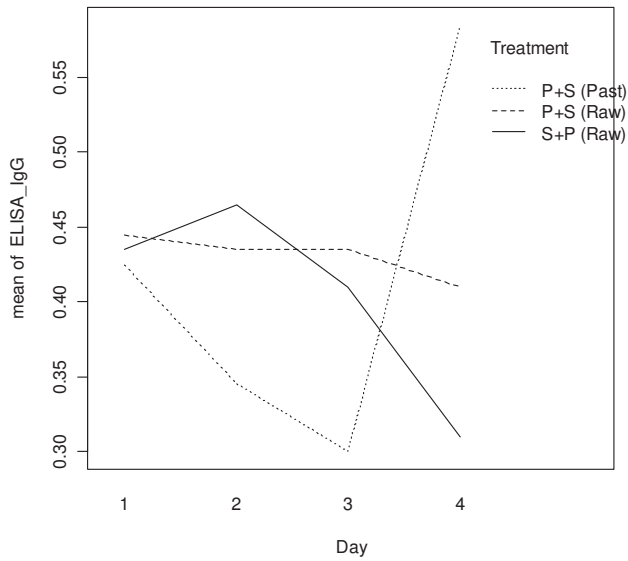

Figure 5-1 continued. Figure continued on next page.

ELISA_IgG

Interaction plot for ELISA_IgG



3. Particle size distribution

PSD_Conc

Interaction plot for PSD_Conc

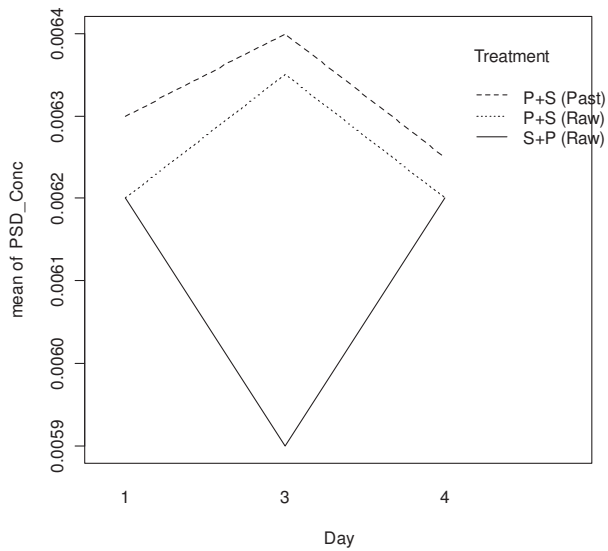

PSD_VWMD

Interaction plot for PSD_VWMD

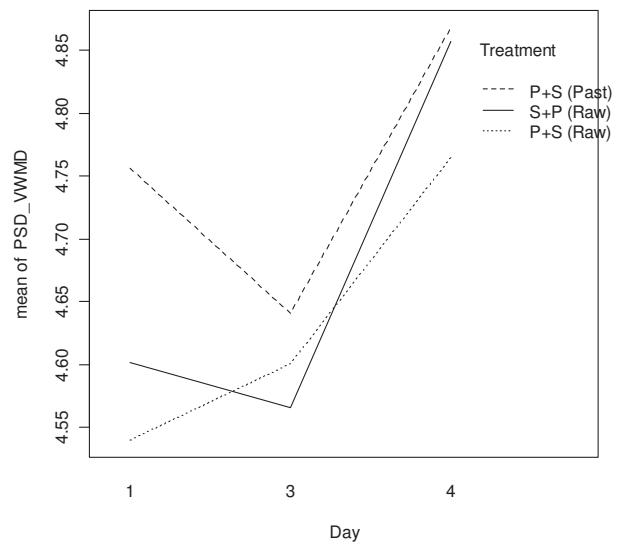
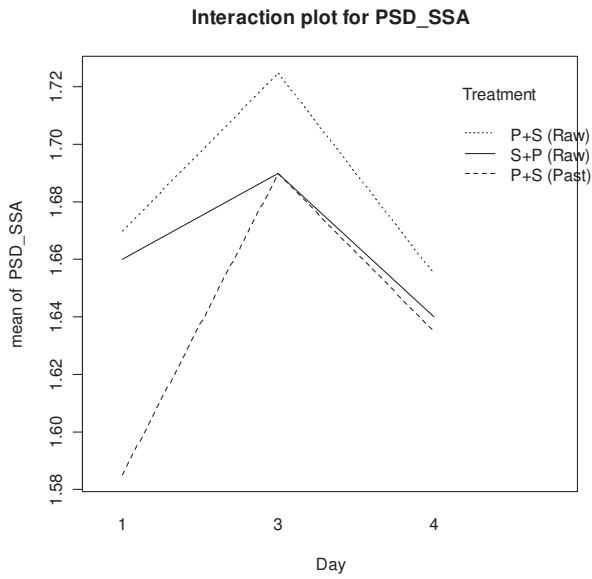
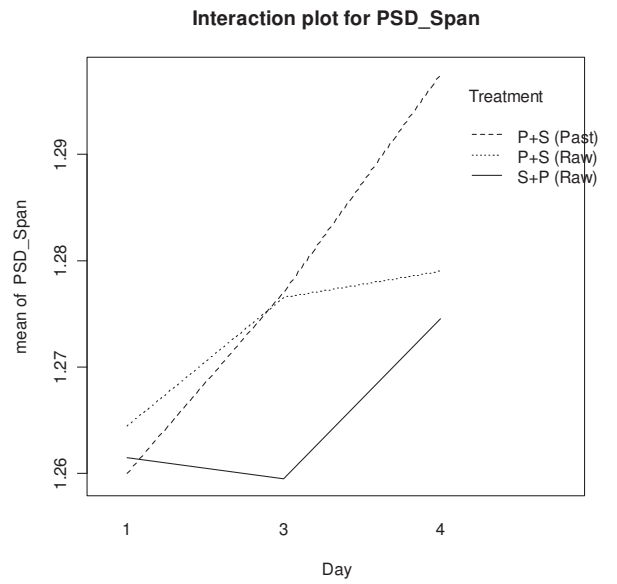

Figure 5-1 continued. Figure continued on next page.

PSD_SSA



PSD_Span



PSD_Unif

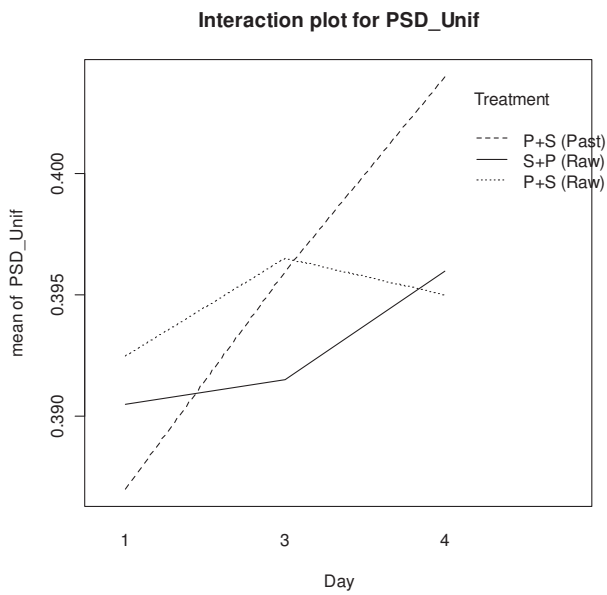

PSD_SWMD

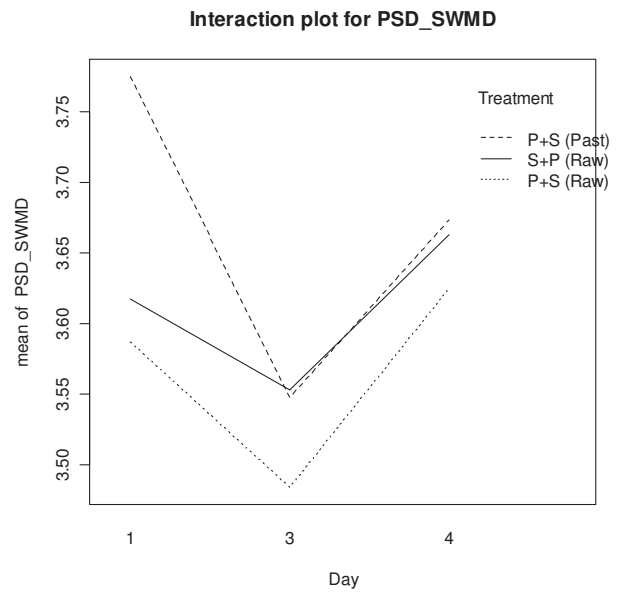
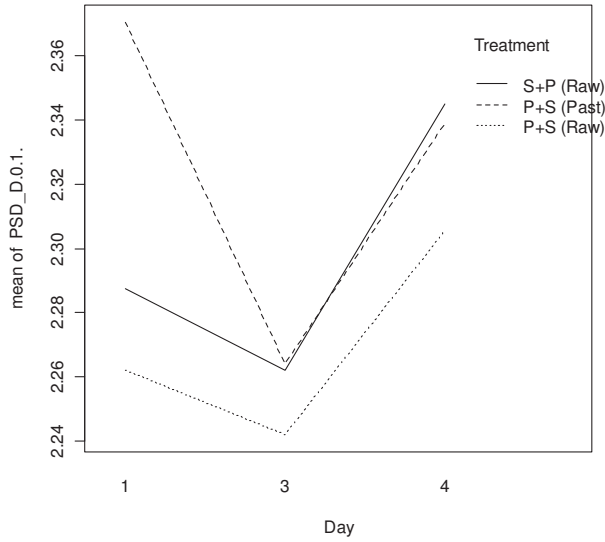

Figure 5-1 continued. Figure continued on next page.

PSD_D(0.1)

Interaction plot for PSD_D.0.1.



PSD_D(0.5)

Interaction plot for PSD_D.0.5.

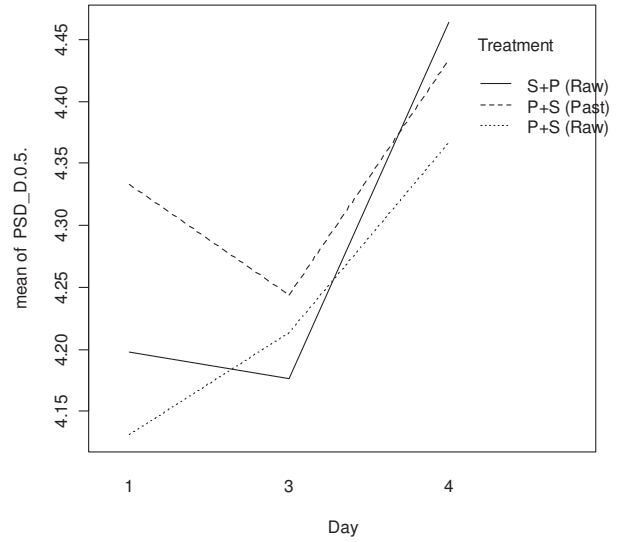

PSD_D(0.9)

Interaction plot for PSD_D.0.9.

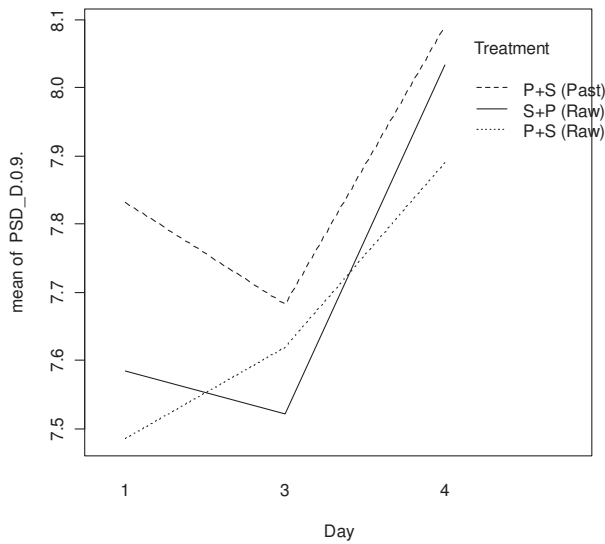

Figure 5-1 continued.

The effect of pasteurisation on a given response was determined by comparing P+S (Past) with the mean of P+S (Raw) and S+P (Raw). The effect of DAY was determined by considering P+S (Past), P+S (Raw) and S+P (Raw) together.

Table 5-1 shows that DAY had significant effects on some whole milk compositional and PSD factors, but that PASTEURISATION had no significant effects at all.

The interaction plots in Figure 5-1 illustrate graphically the absence of significant pasteurisation effects: intersection of two lines (one for pasteurised and one for raw) indicates no absolute difference, while a close approach of the two lines indicates a very small (and in this case insignificant) absolute difference.

The interaction plots also indicate the absence of any effects of the order of P and S, on the basis of the same criteria. This was to be expected, as for whole milk the only difference between S+P and P+S was pasteurisation, as mentioned above; the raw whole milk for the experiments on the two configurations came from the same batch.

The interaction plots show the absolute extent, and pattern, of variation in a given analytical response caused by DAY for each parameter (S+P raw, P+S raw, and P+S past). There is no consistent pattern across all analyses. The absolute size of the DAY effect was small for NCN, CRUDE_PROT, TRUE_PROT and CASEIN, but quite large for some of the minor proteins, as determined by HPLC measurements. The latter finding is possibly partly a reflection of the difficulty of measuring the small contents in milk of these proteins.

Table 5-1 and Figure 5-1 shows that pasteurisation had no effect, and DAY little effect, on whole milk PSD (essentially equivalent to the milk fat globule size distribution). It is noted that the results for PSD have to be considered as a group of responses rather than singly, as the responses are derived from a single experimental measurement.

Microbiological Results

The microbiological results could not be statistically analysed, so the results for the sample groups were examined for general trends. The microbiological results showed that the pasteurised whole milks had lower coliforms, and APCs. The thermotolerant counts of the pasteurised whole milks were generally higher than those of the whole milks.

Conclusions

Pasteurisation had no effects on milk composition or PSD large enough to show up against the batch to batch (DAY to DAY) variation in the raw milk.

5.1.2 Pilot Plant Skim Milk Results

The Pilot Plant skim milk raw data tables (including microbiological results) are displayed in Appendix 3 and the ANOVA models for the PP skim data are displayed in Appendix 4.

p-values for the effects of DAY (raw milk batch), TEMP (separating temperature), DAY:TEMP and ORDER:TEMP are displayed in Table 5-2

Table 5-2 Summary table of ANOVA model p-values for Pilot Plant skim milk data (Separating Temperature)

Signif. codes: 0 '***' 0.001 '**' 0.01 '*' 0.05 '.' 0.1 ' ' 1

RESPONSE	DAY	TEMP	DAY:TEMP	ORDER:TEMP
Chem analyses				
NCN	3.352e-05 ***	0.3353952	0.7028526	0.9109363
NPN	1.731e-05 ***	0.364554	0.8600046	0.4457325
TN_LIQ	0.001973 **	0.271618	0.845158	0.257725
CRUDE_PROT	5.041e-05 ***	0.355	0.8529	0.3164
TRUE_PROT	0.0001557 ***	0.4077447	0.8177332	0.3685763
FAT.RG	0.006696 **	0.456013	0.855603	0.887091
TS	1.209e-06 ***	0.9807	0.2806	0.5565
CASEIN	0.0005294 ***	0.5618352	0.650022	0.3412594
WHEY_PROT	3.926e-05 ***	0.266203	0.873017	0.754462
C.WP_RATIO	0.0002525 ***	0.3404669	0.6254721	0.4902294
MSCAN_PROT †	----	0.67324	----	----
MSCAN_TS †	----	0.1451	----	----
Minor proteins				
HPLC_pp5	4.359e-10 ***	0.39569	0.07554 .	0.65131
HPLC_ALA	3.792e-08 ***	0.7188	0.1084	0.7263
HPLC_LF	2.548e-11 ***	0.4265	0.3267	0.7407
HPLC_BSA	1.469e-08 ***	0.8799	0.14772	0.22852
HPLC_BLG	2.819e-07 ***	0.6044529	0.126899	0.7177944
HPLC_IgG	5.597e-07 ***	0.544598	0.202116	0.769001
ELISA_IgG	0.0089193 **	0.7986794	0.3441907	0.8801414

† measurements for day 4 only, no factor DAY in model

The p-values in Table 5-2 show that TEMP (separating temperature), DAY:TEMP, and ORDER:TEMP had no significant effects on the responses (apart from a just significant effect of DAY:TEMP on HPLC_pp5). But the HPLC results should be considered as a group. Thus it can be said that the DAY:TEMP interaction has no effect on the whey proteins.

p-values for the effects of DAY (raw milk batch), ORDER, PASTEURISATION, DAY:ORDER, and DAY:PASTEURISATION are displayed in Table 5-3.

Table 5-3 Summary table of ANOVA model p-values for Pilot Plant skim milk data (Pasteurisation)

Signif. codes: 0 '***' 0.001 '**' 0.01 '*' 0.05 '.' 0.1 ' ' 1

RESPONSE	DAY	ORDER	PAST	DAY:ORDER	DAY:PAST
Chem analyses					
NCN	3.352e-05 ***	----	6.487e-05 ***	----	0.03083 *
NPN	1.731e-05 ***	0.0004835 ***	0.0019162 **	0.0013262 **	----
TN_LIQ	0.001973 **	----	----	0.011095 *	----
CRUDE_PROT	5.041e-05 ***	----	----	0.008621 **	----
TRUE_PROT	0.0001557 ***	----	----	0.0390230 *	----
FAT.RG	0.006696 **	----	----	----	----
TS	1.209e-06 ***	5.623e-07 ***	6.236e-06 ***	1.241e-09 ***	2.586e-07 ***
CASEIN	0.0005294 ***	----	----	0.0051422 **	----
WHEY_PROT	3.926e-05 ***	0.02590 *	0.00214 **	0.03259 *	0.04161 *
C.WP_RATIO	0.0002525 ***	0.0212914 *	0.0063786 **	0.0043392 **	0.0391214 *
MSCAN_PROT †	x	----	0.03974 *	x	x
MSCAN_TS †	x	2.920e-05 ***	6.787e-05 ***	x	x
Minor proteins					
HPLC_pp5	4.359e-10 ***	1.487e-05 ***	----	9.214e-06 ***	0.0004657 ***
HPLC_ALA	3.792e-08 ***	----	----	----	----
HPLC_LF	2.548e-11 **	3.224e-09 ***	1.388e-06 ***	1.930e-07 ***	0.001664 **
HPLC_BSA	1.469e-08 ***	0.0006373 ***	5.808e-08 ***	0.0055947 **	----
HPLC_BLG	2.819e-07 ***	----	0.0001252 ***	0.0067997 **	----
HPLC_IgG	5.597e-07 ***	0.002119 **	5.093e-10 ***	0.001459 **	----
ELISA_IgG	0.0089193 **	----	0.0001280 ***	----	----

† measurements for day 4 only, no factor DAY in model

Cross-over interaction

Figure 5-2 shows the interaction plots for the Pilot Plant skim milks.

CHEM VARIABLES

NOTE: each line represents a treatment, S+P (raw), S+P (past) or P+S (past) – see legend

NCN

NPN

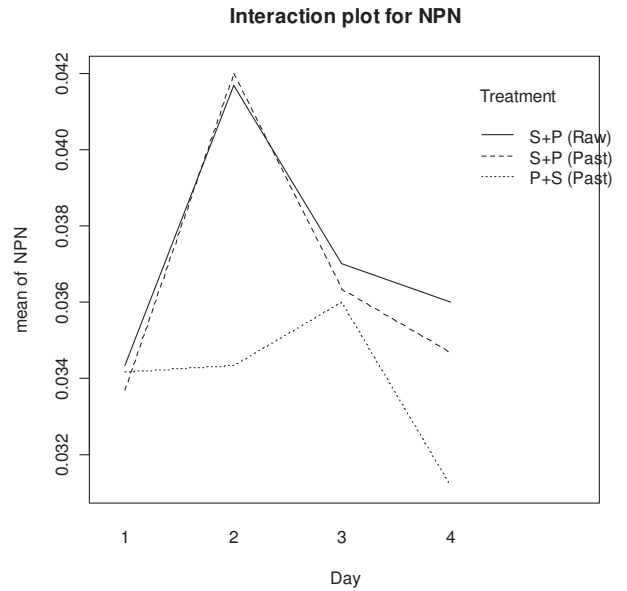
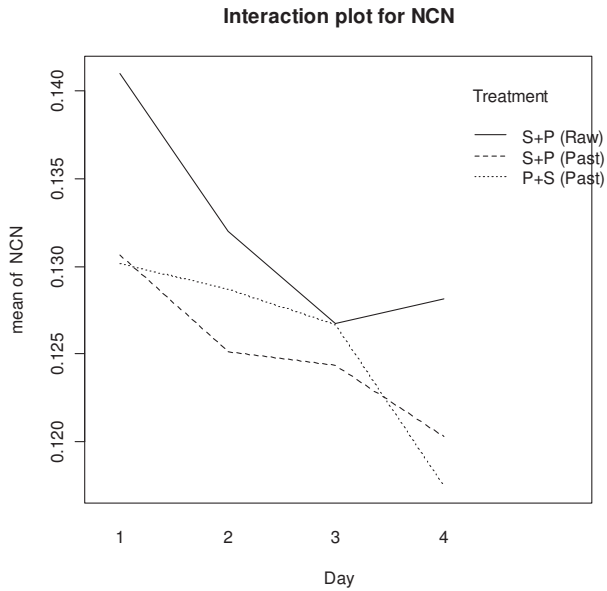

TN_LIQ

CRUDE_PROT

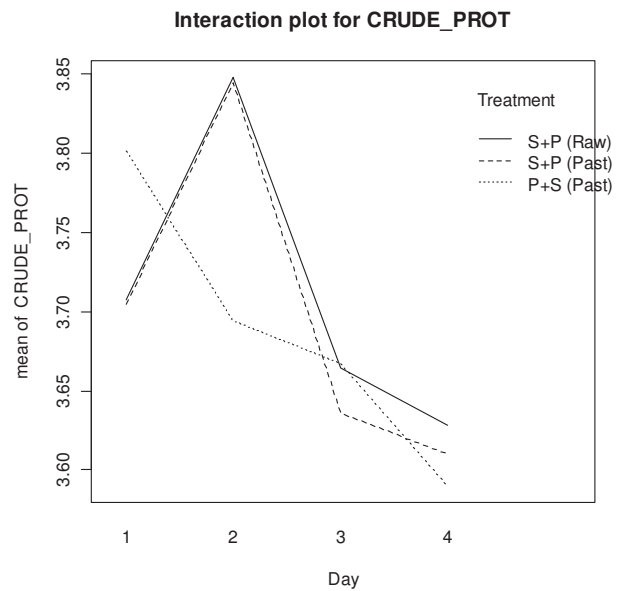
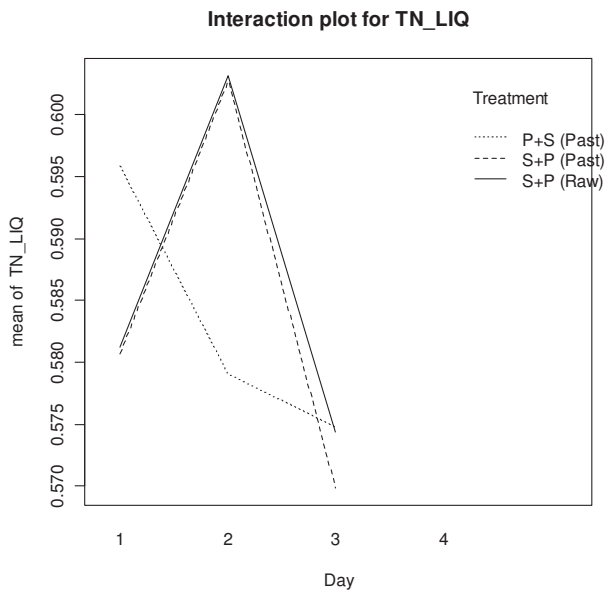
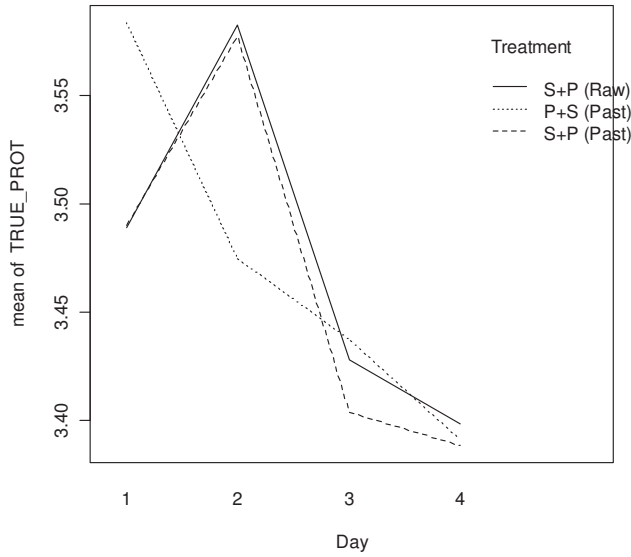

Figure 5-2 Interaction Plots for Pilot Plant skim milk. Figure continued on next page.

TRUE_PROT

Interaction plot for TRUE_PROT



FAT.RG

Interaction plot for FAT.RG

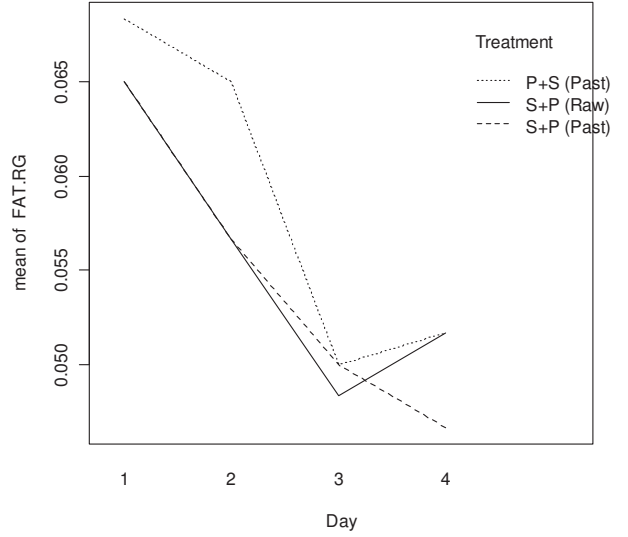

TS

Interaction plot for TS

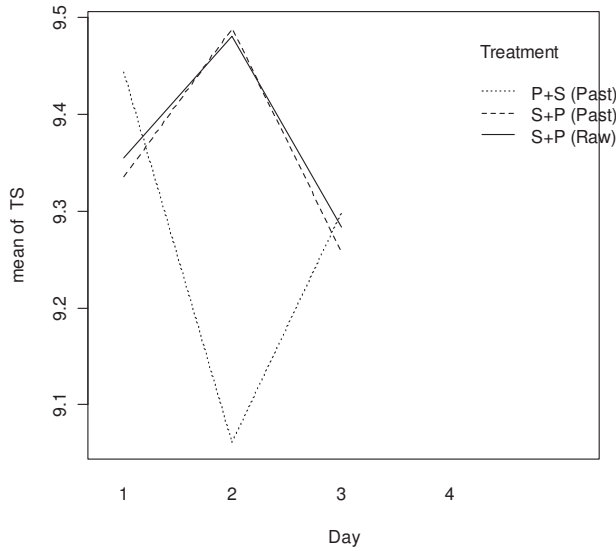

CASEIN

Interaction plot for CASEIN

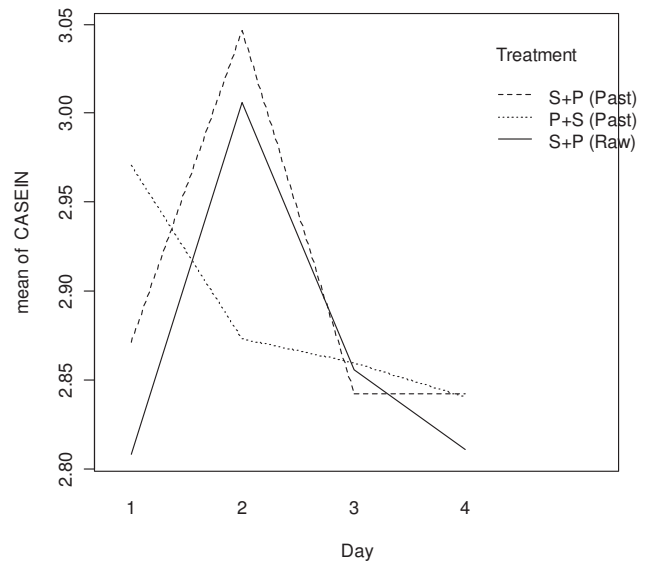
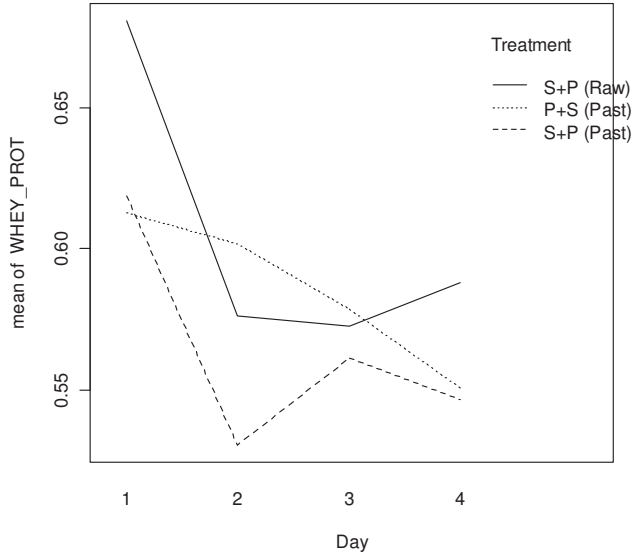

Figure 5-2 continued. Figure continued on next page.

WHEY_PROT

Interaction plot for WHEY_PROT



C.WP_RATIO

Interaction plot for C.WP_RATIO

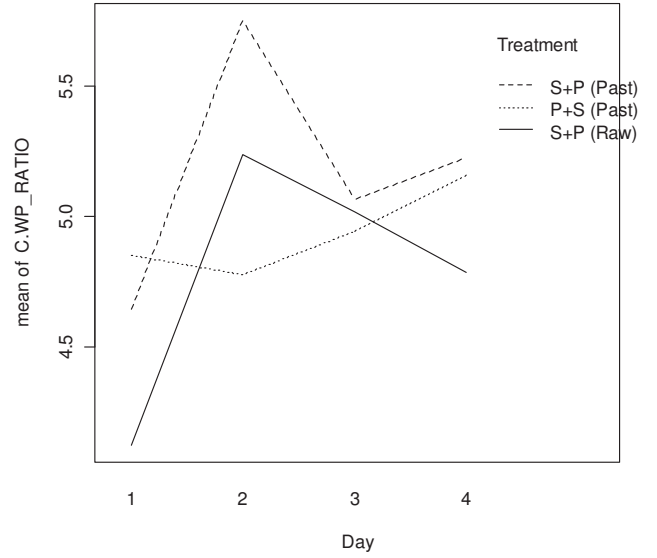

MSCAN_PROT

Plot for MSCAN_PROT

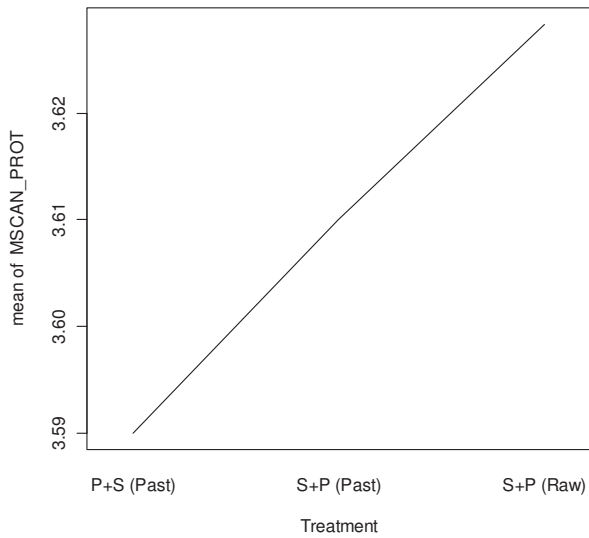

MSCAN_TS

Plot for MSCAN_TS

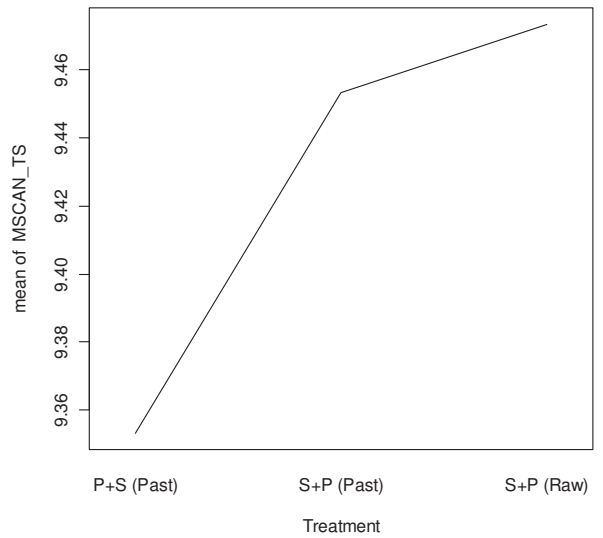
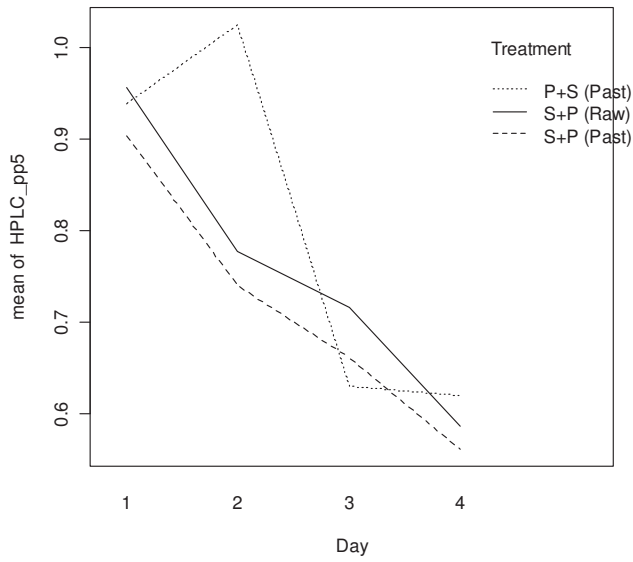

Figure 5-2 continued. Figure continued on next page.

MINOR PROTEINS

HPLC_pp5

Interaction plot for HPLC_pp5



HPLC_ALA

Interaction plot for HPLC_ALA

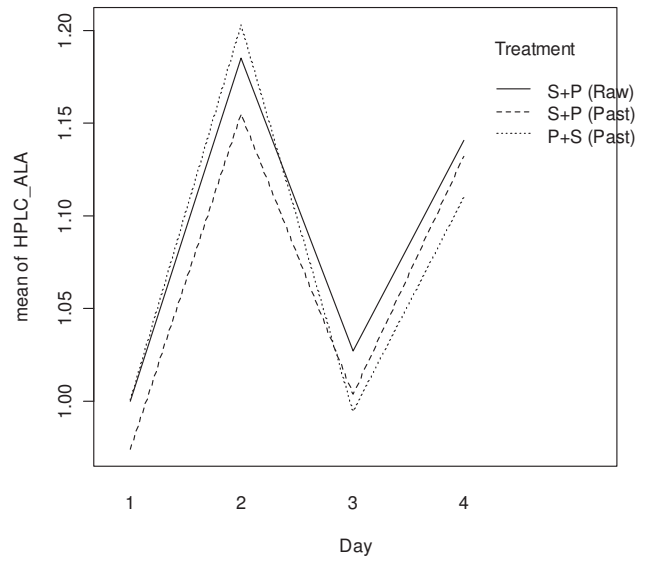

HPLC_LF

Interaction plot for HPLC_LF

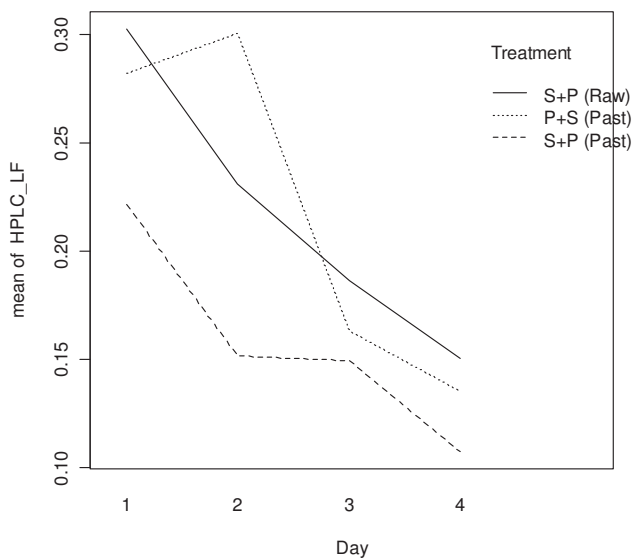

HPLC_BSA

Interaction plot for HPLC_BSA

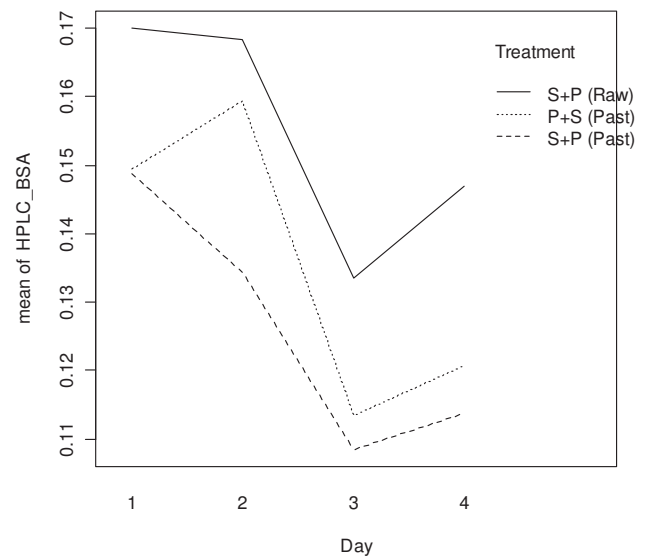
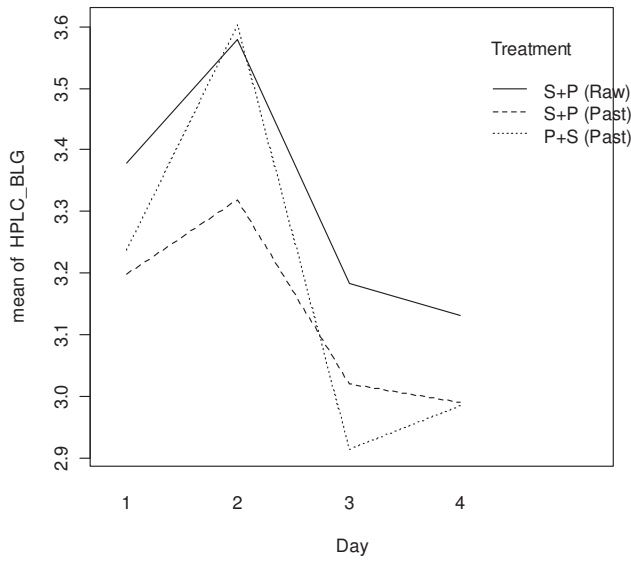

Figure 5-2 continued. Figure continued on next page.

HPLC_BLG

Interaction plot for HPLC_BLG



HPLC_IgG

Interaction plot for HPLC_IgG

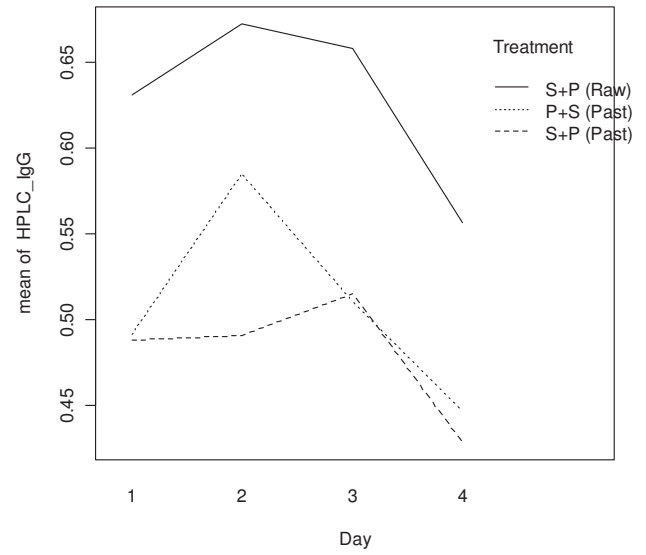

ELISA_IgG

Interaction plot for ELISA_IgG

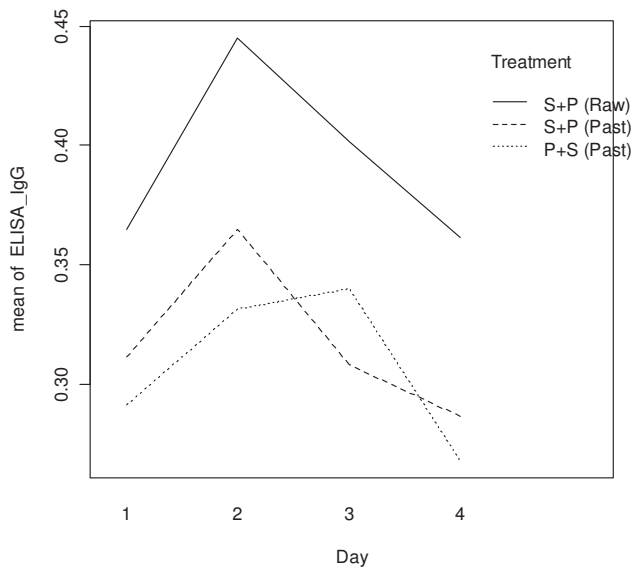

Figure 5-2 continued.

The percentage changes in skim milk composition variables for the PP skim milk data are shown in Table 5-4.

Table 5-4 Percentage changes in milk composition variables for Pilot Plant skim milk data

RESPONSE	ORDER (S+P → P+S)	PAST (Raw → Past)	COMMENT
Chem analyses			
NCN	0.5	-5	
NPN	-7.5	-5.3	P+S only
TN_LIQ	-0.2	-0.41	
CRUDE_PROT	-0.29	-0.5	
TRUE_PROT	0.2	-0.18	
FAT.RG	7.6	2.3	
TS	-1	-0.63	Days 1 - 3
CASEIN	-0.5	0.8	
WHEY_PROT	3.8	-4.8	S+P only
C.WP_RATIO	-4.6	5.4	S+P only
MSCAN_PROT	-0.55	-0.78	Day 4 only
MSCAN_TS	-1.1	-0.74	Day 4 only
Minor proteins			
HPLC_pp5	12	0.14	
HPLC_ALA	1	-1.5	
HPLC_LF	40	-13	S+P only
HPLC_BSA	7.4	-15	
HPLC_BLG	1.7	-4.8	S+P only
HPLC_IgG	5.7	-21	
ELISA_IgG	-3.1	-20	

Note :

Table entries are **highlighted** as being significant **absolute** changes when

The factor (ORDER/PAST) is statistically significant (p-value < 0.05)

AND

The interaction with DAY is not significant

OR

The interaction with DAY is significant but is not **cross-over**

A **cross-over** interaction is one in which the two lines intersect. **Significant** entries with **cross-over** are **highlighted**.

Note: Non-constant variability across DAY:TREATMENT subgroups questions the validity of the model.

Separating temperature has not been considered in Table 5-3 because the results in Table 5-2 show that it had no significant effect.

DAY was highly significant for all responses for which relevant data were obtained. ORDER and PAST were significant for some responses. The interactions DAY:ORDER and DAY:PAST were also significant for some responses.

For most of the significant interaction effects, there were cross-over interactions: these indicate that the effect of, for example, ORDER varied from positive to negative over days.

The meaning of these results can be explained by considering the results for HPLC_Lf (lactoferrin) as an example:

- The main factors ORDER and PAST are significant
- The DAY:ORDER and DAY:PAST interactions are also significant
- The ORDER effect is clearly shown in the interaction plot for HPLC_Lf (Figure 5-2). The line for P+S (Past) lies above the line for S+P (Past) for all four days; the lines do not intersect.
- The interaction between DAY and ORDER is shown by the fact that the two lines differ markedly in shape: the extent of the difference between P+S (Past) and S+P (Past) depended on DAY.
- It appears that pasteurisation in the S+P configuration resulted in a lower lactoferrin content than did pasteurisation in the P+S configuration, but the difference between the two depended on DAY (milk batch).
- However, for lactoferrin, there is a cross-over interaction between DAY and PAST, as shown by the intersection of the S+P (Raw) and the P+S (Past) lines in Figure 5-2. Statistically, S+P (Raw) was compared with the average of S+P(Past) and P+S (Past). This means that the effect of pasteurisation and the direction of that effect (positive or negative) depended on DAY (batch). Therefore, the effect of PAST, though significant, is confounded with day-to-day (batch-to-batch) inconsistency in the composition of the raw milk.
- The intersection of the S+P (Raw) line with the P+S (Past) line in the interaction plot for HPLC_Lf (Figure 5-2), and the absence of intersection between the P+S (Past) and the S+P (Past) lines, indicates that the effect of pasteurisation depended on the order of separation and pasteurisation. In contrast, the interaction plots for HPLC_BSA, HPLC_IgG and ELISA_IgG, where there is no intersection between the (S+P (Raw) line and either of the other two lines, show that the clear effect of pasteurisation was independent of the order of separation and pasteurisation.

The results for other responses could be discussed in a similar way. For some responses, the DAY:ORDER effect (evaluated by comparing P+S(Past) with the average of S+P(Raw) and S+P(Past), over DAYS) exhibited crossover. In other words, the DAY effect (batch-to-batch effect) obscured the effect of ORDER.

However, it is more appropriate, given the nature of the statistical analyses carried out, to consider the results as one group rather than singly.

Absolute percentage changes in responses caused by ORDER and PAST are summarised in Table 5-4:

- Changes, whether positive or negative, were generally small, the exception being the large negative change in the heat sensitive protein IgG caused by pasteurisation. It is noted that the HPLC and ELISA results for IgG are in good agreement.
- It is clear from Table 5-4 that, overall, for the responses listed, the precise effects of ORDER and PAST were obscured by the effect of DAY (milk batch). In other words, variations in the composition of skim milk caused by ORDER and/or PAST were within the ranges to be expected from the normal batch to batch variation in raw milk composition.

Microbiological Results

The microbiological results of the skim milks were not analysed statistically.

The coliform, thermophile, thermoduric, and APC counts of the pasteurised skim samples from both S+P and P+S configurations were very similar.

5.1.3 Pilot Plant Cream Results

The raw data for the PP creams are shown in Appendix 5. The ANOVA results for the PP creams are displayed in Appendix 6.

There are no results for minor proteins as determined by HPLC as HPLC cannot be performed on high fat materials.

Insufficient data were obtained to allow complete analysis for particle size distribution. No measurements were conducted on the samples from Day 2, and none were performed on the samples for some separating temperatures on days 1 and 3. The tests were not performed on all the samples from Days 1 and 3 due to the high workload of the lab technicians.

A summary of the p values from the ANOVA models for the effects of TEMP (separating temperature) are displayed in Table 5-5.

Table 5-5 Summary table of ANOVA model p-values for Pilot Plant cream data (TEMP)

Signif. codes: 0 '***' 0.001 '**' 0.01 '*' 0.05 '.' 0.1 ' ' 1

Response	DAY	TEMP	DAY:TEMP	TREAT:TEMP
Chemical				
MSCAN_PROT	5.302e-09 ***	0.0124418 *	0.1810598	0.3963226
MSCAN_FAT	3.384e-05 ***	0.1867122	0.7510456	0.8672733
MSCAN_TS	1.029e-05 ***	0.1549677	0.798992	0.8542905
PSD				
PSD_Conc	0.14184	0.07298 .	0.34207	0.65655
PSD_VWMD	0.3913	0.3126	0.2672	0.5522
PSD_SSA	0.2457	0.2143	0.1813	0.3273
PSD_Span	0.3256	0.3328	0.3053	0.611
PSD_Unif	0.3301	0.327	0.3068	0.601
PSD_SWMD	0.3244	0.2764	0.2236	0.4413
PSD_D(0.1)	0.2275	0.219	0.1585	0.2542
PSD_D(0.5)	0.3566	0.2393	0.2449	0.4604
PSD_D(0.9)	0.3926	0.3412	0.2793	0.5897

A summary of the p values for the ANOVA models for the PP cream data (effects of DAY, ORDER and PAST) is found in Table 5-6.

Table 5-6 Summary table of ANOVA model p-values for Pilot Plant cream data (Pasteurisation)

Signif. codes: 0 '***' 0.001 '**' 0.01 '*' 0.05 '.' 0.1 ' ' 1

RESPONSE	DAY	ORDER	PAST	DAY:ORDER	DAY:PAST
Chem analyses					
MSCAN_PROT	5.302e-09 ***	2.702e-05 ***	0.0027907 **	0.0003736 ***	0.0326403 *
MSCAN_FAT	3.384e-05 ***	----	----	0.0001486 ***	0.0385705 *
MSCAN_TS	1.029e-05 ***	----	----	0.0001096 ***	0.0300440 *
PSD variables					
PSD_Conc	----	----	----	----	----
PSD_VWMD	----	----	----	----	----
PSD_SSA	----	----	----	----	----
PSD_Span	----	----	----	----	----
PSD_Unif	----	----	----	----	----
PSD_SWMD	----	----	----	----	----
PSD_D(0.1)	----	----	----	----	----
PSD_D(0.5)	----	----	----	----	----
PSD_D(0.9)	----	----	----	----	----

Cross-over interaction - change is not absolute – we can't tell if it is an increase or decrease.

The interaction plots for the pilot plant creams are shown in Figure 5-3. The plots show the presence or absence of interactions between DAY and ORDER, and between DAY and PAST.

Chemical analyses

NOTE: each line represents a treatment, S+P (raw), S+P (past) or P+S (past) – see legend

MSCAN_PROT

Interaction plot for MSCAN_PROT

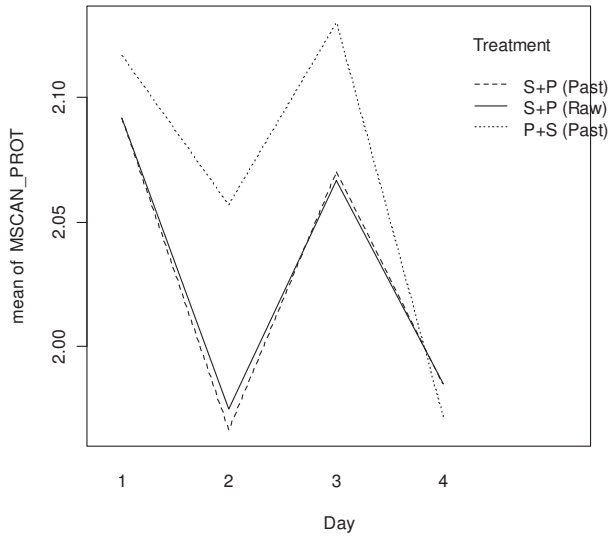

MSCAN_FAT

Interaction plot for MSCAN_FAT

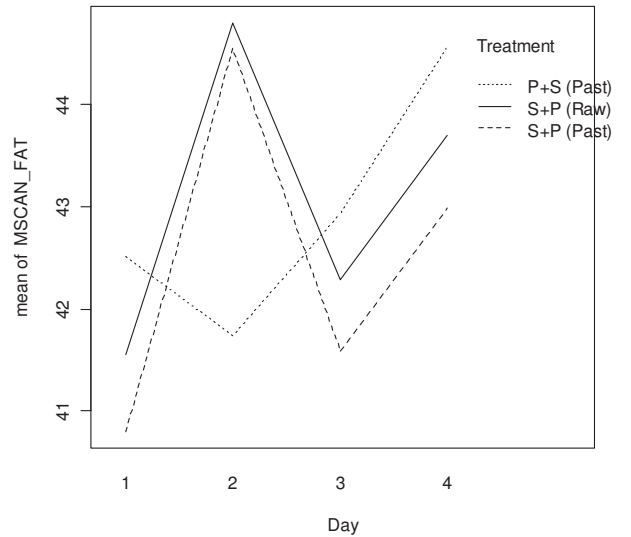

MSCAN_TS

Interaction plot for MSCAN_TS

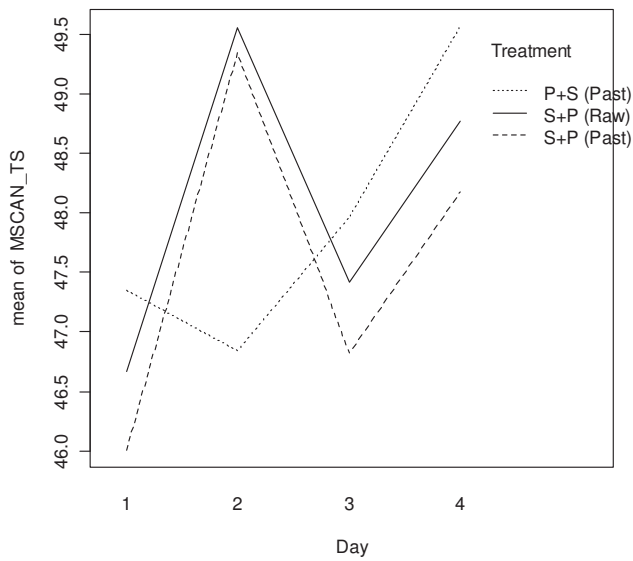
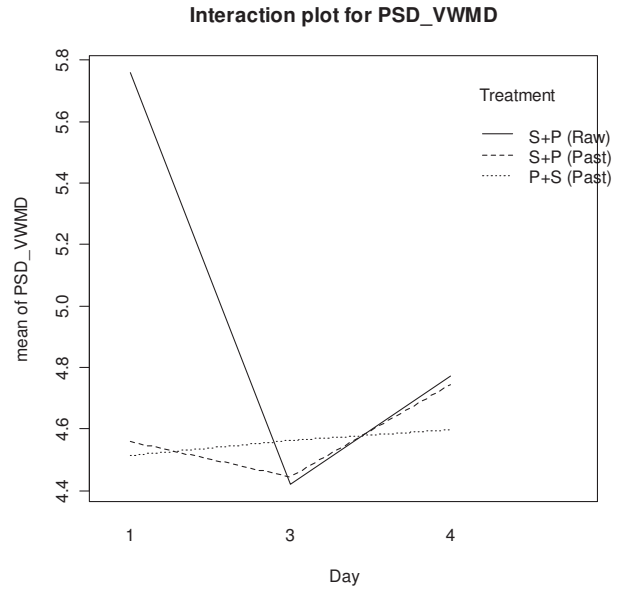
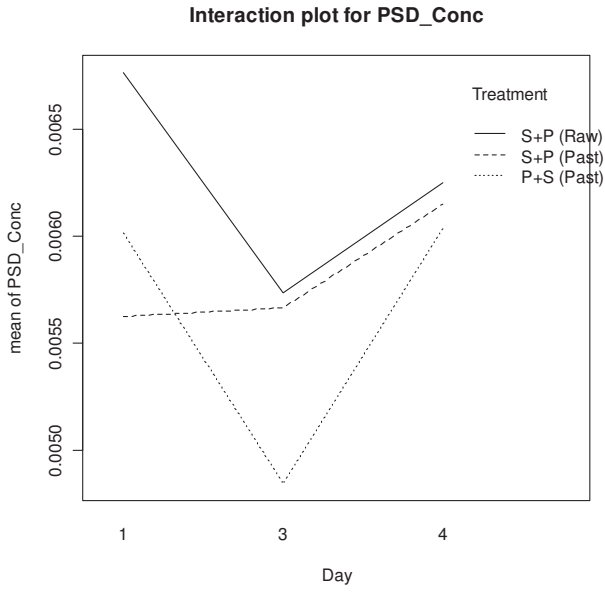

Figure 5-3 Interaction plots for Pilot Plant cream. Figure continued on next page.

PSD variables

PSD_Conc

PSD_VWMD



PSD_SSA

PSD_Span

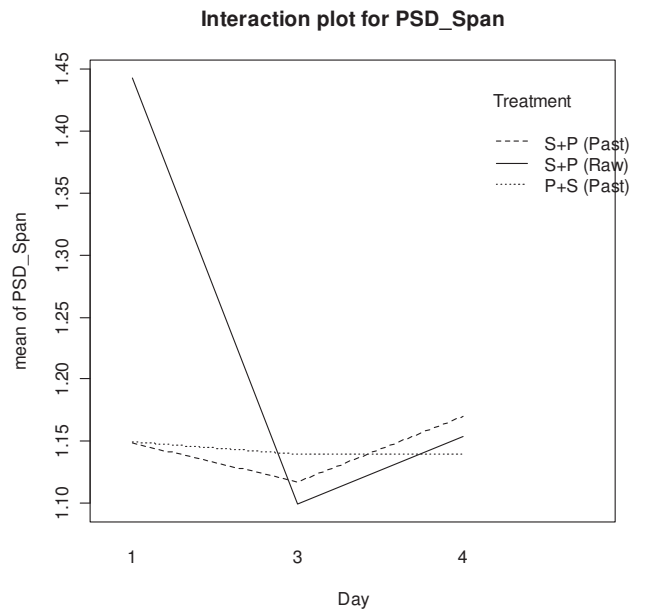
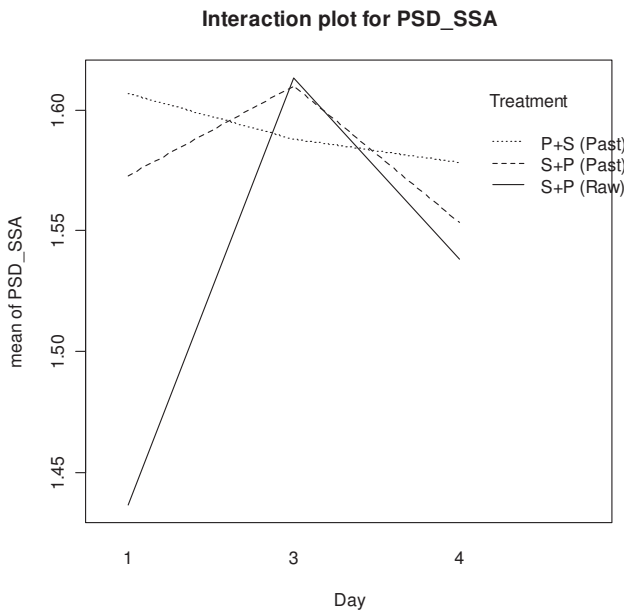
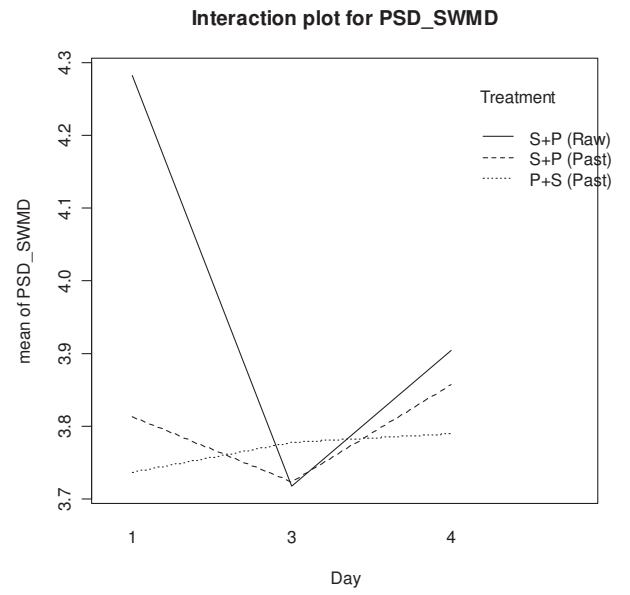
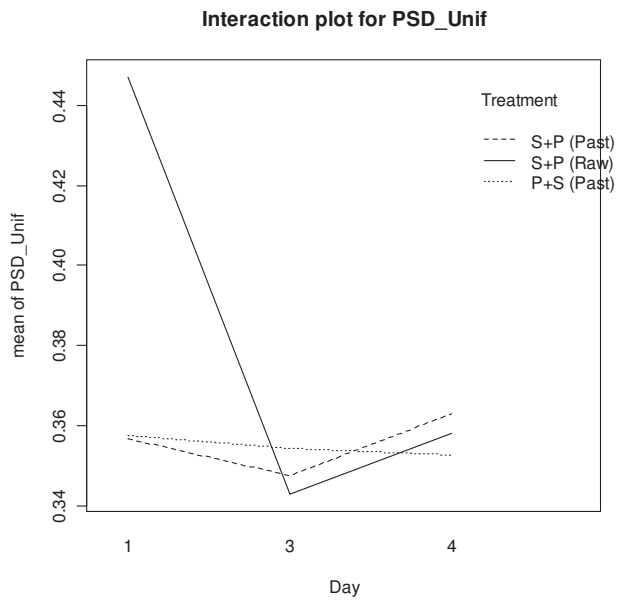

Figure 5-3 continued. Figure continued on next page.

PSD_Unif

PSD_SWMD



PSD_D(0.1)

PSD_D(0.5)

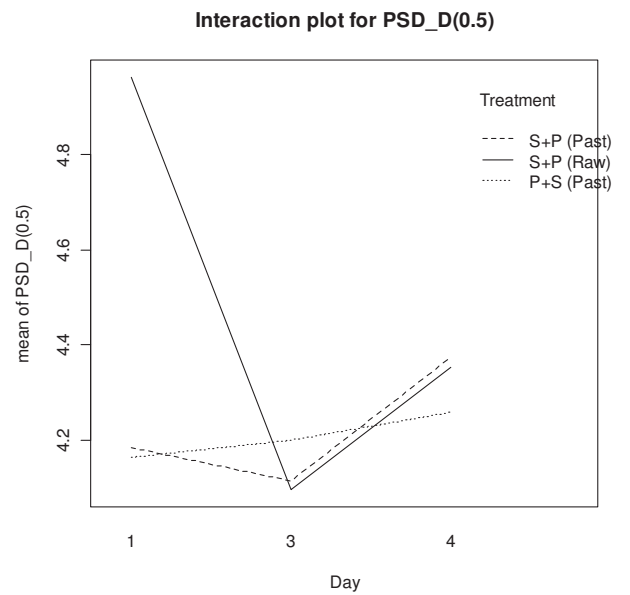
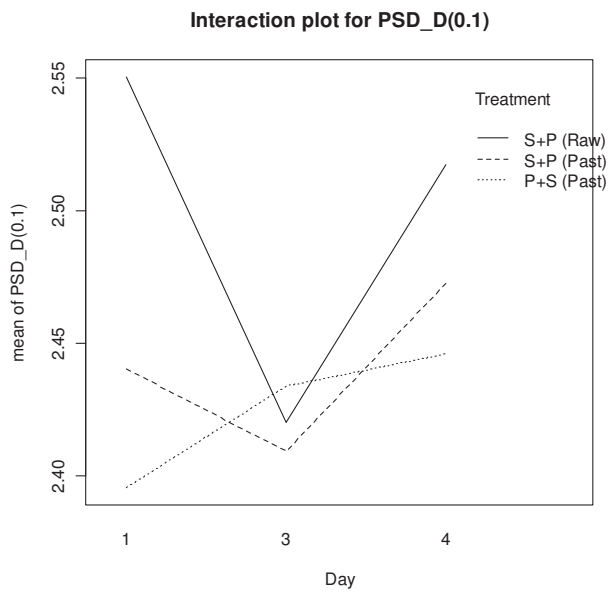

Figure 5-3 continued. Figure continued on next page.

PSD_D(0.9)

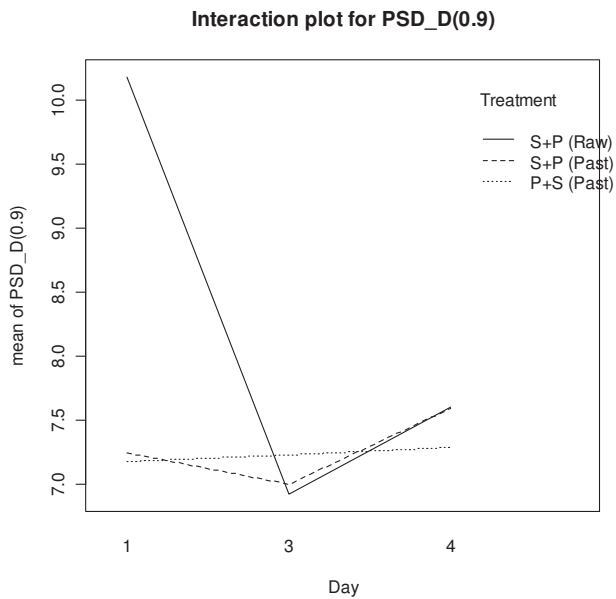

Figure 5-3 continued.

The percentage changes in milk composition variables for the pilot plant cream samples are displayed in Table 5-7.

Table 5-7 Percentage changes in milk composition variables for Pilot Plant cream data

RESPONSE	ORDER (S+P → P+S)	PAST (Raw → Past)
Chem analyses		
MSCAN_PROT	2	0.93
MSCAN_FAT	1.1	-0.87
MSCAN_TS	0.72	-0.72
PSD variables		
PSD_Conc	-2.7	-7.9
PSD_VWMD	-0.63	-8.3
PSD_SSA	0.74	3.7
PSD_Span	-0.14	-7.2
PSD_Unif	-0.19	-7.2
PSD_SWMD	-0.76	-4.7
PSD_D.0.1	-0.66	-2.5
PSD_D.0.5	-0.51	-5.7
PSD_D.0.9	-0.7	-12

A **cross-over** interaction is one in which the two lines intersect. **Significant** entries with **cross-over** are **highlighted**.

No significant differences were found between the A and B samples.

As for the pilot plant skim milks, the p-values in Table 5-5 indicate that, overall, TEMP (separating temperature) had no significant effects on the responses, except in the case of MSCAN_PROT, and that DAY:TEMP and ORDER:TEMP interactions were all insignificant.

The DAY (milk batch) effect was significant for MSCAN_PROT, MSCAN_FAT, and MSCAN_TS, but not for the particle size distribution. This is possibly due to the lack of particle size distribution data, as discussed previously.

The effect of TEMP (separating temperature) is not included in Table 5-6, as the results in Table 5-5 show that it had no effect on the responses, except in the case of MSCAN_PROT, as stated above.

As indicated in Table 5-6 and illustrated in Figure 5-3, the DAY:ORDER and DAY:PAST interactions were all significant, but exhibited cross-over: the day-to-day (batch-to-batch) effects on responses were both positive and negative. Thus the effect of DAY was inconsistent, and obscured the effects of ORDER and PAST.

The percentage changes in responses caused by ORDER and PAST effects are shown in Table 5-7. The only significant changes are those for MSCAN_PROT, but because of the cross-over caused by day-to-day inconsistency, the true effects of ORDER and PAST on this response are veiled.

For cream, the overall conclusion to be drawn is that variations in cream composition (as measured by MilkoScan) caused by ORDER and TEMP (separating temperature) were inconsistent over DAYS, suggesting that they were within the ranges of normal batch-to-batch variations in the composition of the raw milk. Thus it can be further concluded that order of separation and pasteurisation, and separating temperature, had no effects of consequence on pasteurised cream composition. Owing to the incomplete data, no firm conclusions can be drawn regarding the effect of these factors on cream milk fat globule particle size distribution.

Microbiological results

The raw data from the microbiological analyses performed on the PP creams is displayed in Appendix 5. Statistical analysis could not be performed on the microbiological data.

In general, the raw and pasteurised S+P creams had similar coliform, APC, thermophile and thermoduric counts.

5.1.4 Pilot Plant Sludge Results

The raw data for the chemical composition analyses performed on the PP sludges is displayed in Appendix 7. The ANOVA outputs for the sludges are shown in Appendix 8.

No A and B samples were taken of the separator sludge, as there was only one desludge per separating temperature used.

The sludge samples did not have microbiological analyses performed on them.

The p-values for the ANOVA models for the PP sludge data appear in Table 5-8.

Table 5-8 Summary table of ANOVA model p-values for Pilot Plant sludge data

Signif. codes: 0 ‘***’ 0.001 ‘**’ 0.01 ‘*’ 0.05 ‘.’ 0.1 ‘ ’ 1

RESPONSE	DAY	PAST	TEMP	DAY:PAST	DAY:TEMP
Chemical					
NCN	3.288e-06 ***	2.837e-07 ***	0.01941 *	----	0.02186 *
NPN	2.611e-06 ***	7.470e-05 ***	0.02473 *	0.01416 *	----
TN_LIQ	0.0003997 ***	----	0.0103012 *	----	0.0639134 .
FAT_RG	----	----	----	----	----
TS	0.0001326 ***	0.0674878 .	0.0187627 *	----	0.0442125 *
CRUDE_PROT	0.0003844 ***	----	0.0101120 *	----	0.0641536 .
TRUE_PROT	0.0006232 ***	----	0.0110421 *	----	0.0643395 .
CASEIN	0.001847 **	----	0.012224 *	----	----
WHEY_PROT	2.601e-05 ***	6.650e-07 ***	0.05339 .	----	0.02619 *
C.WP_RATIO	0.002302 **	5.194e-06 ***	----	0.021164 *	----
Minor Proteins					
HPLC_pp5	0.002999 **	0.004572 **	----	0.057218 .	----
HPLC_ALA	0.000671 ***	6.286e-05 ***	----	----	0.067396 .
HPLC_Lf	7.708e-05 ***	----	----	----	0.06942 .
HPLC_BSA	3.691e-06 ***	----	----	0.001199 **	0.042846 *
HPLC_BLG	2.838e-06 ***	0.024306 *	0.029323 *	0.017082 *	0.004542 **
HPLC_IgG	0.0007814 ***	0.0008149 ***	----	----	0.0998099 .
Minerals					
MIN_Ca	0.01576 *	----	0.08188 .	----	/
MIN_K	0.0001575 ***	----	----	----	/
MIN_Mg	0.0002426 ***	----	0.0325371 *	----	/
MIN_Na	1.083e-05 ***	----	0.06656 .	----	/
MIN_P	0.008989 **	----	0.071478 .	----	/
MIN_IP_AS_PO4	0.004235 **	----	----	----	/

Cross-over interaction

Order of separation and pasteurisation are confounded as treatments are S+P (Raw) and P+S (Past); the effect of order is actually the effect of pasteurisation.

Interaction plots for PP sludge samples are displayed in Figure 5-4. The interaction plots show the presence or absence of interactions between DAY and treatment (pasteurisation).

CHEM VARIABLES

NCN

NPN

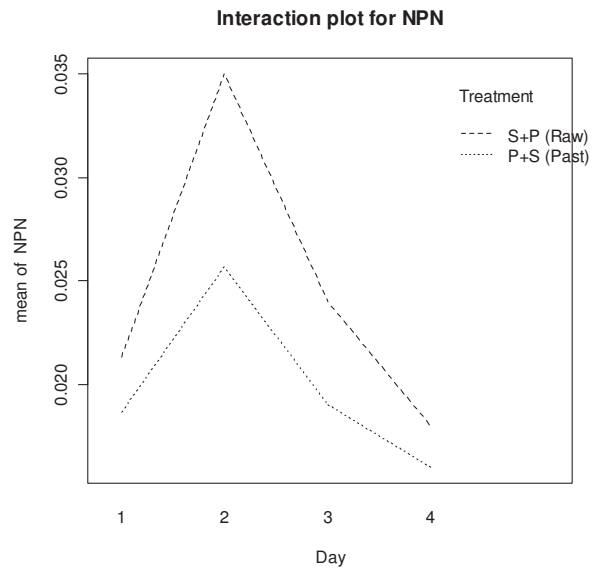
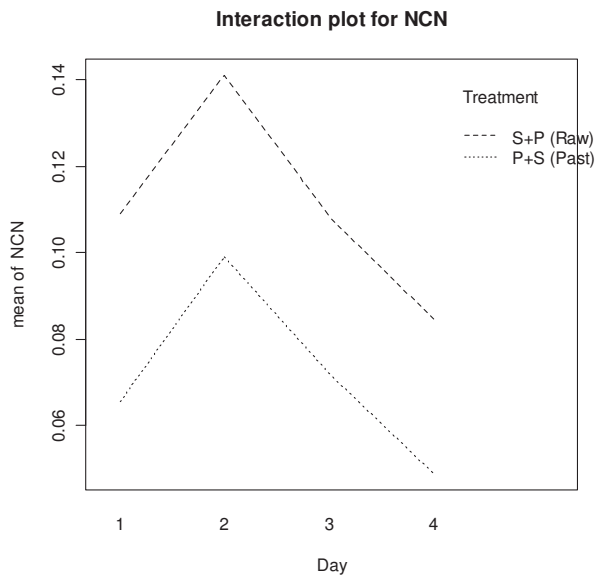

TN_LIQ

FAT_RG

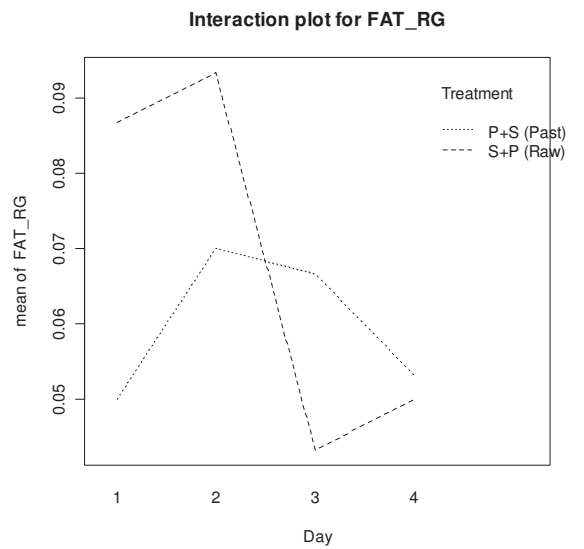
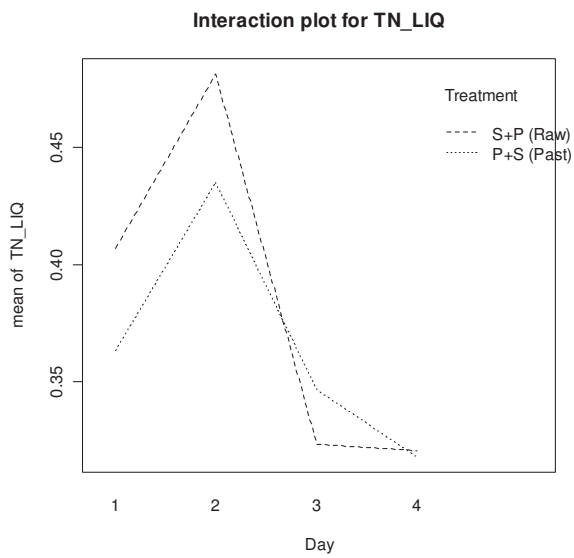
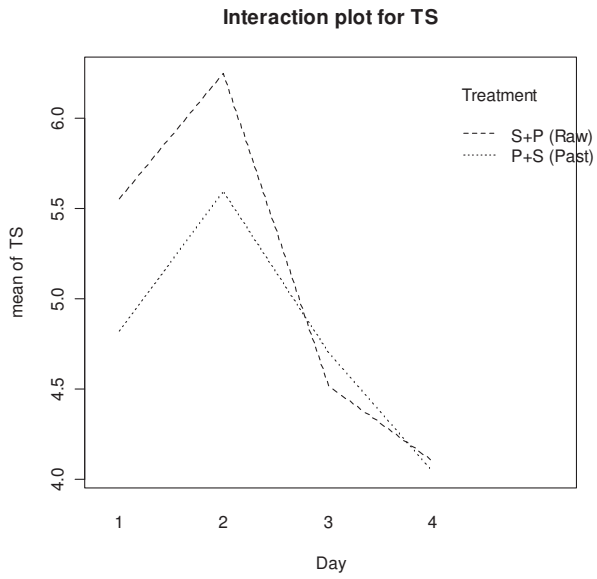
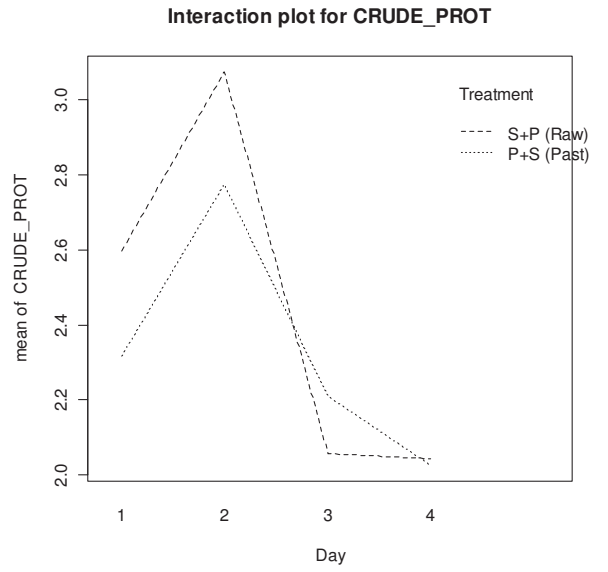

Figure 5-4 Interaction Plots for Pilot Plant sludge. Figure continued on next page.

TS



CRUDE_PROT



TRUE_PROT



CASEIN

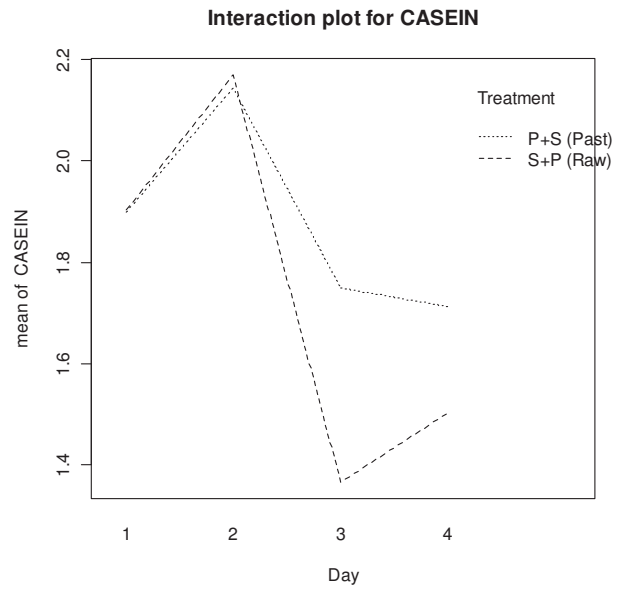
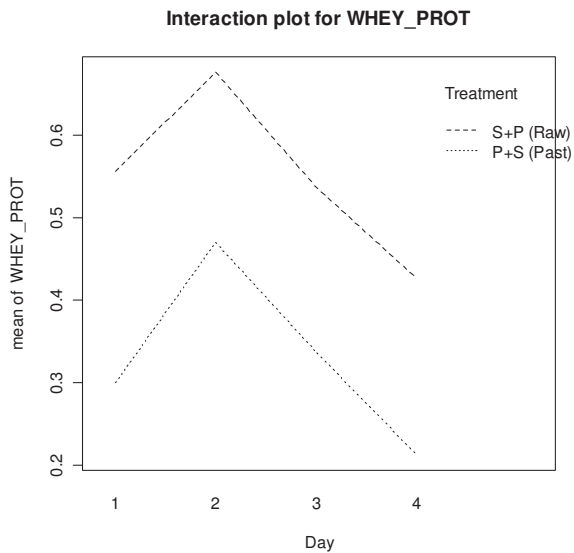
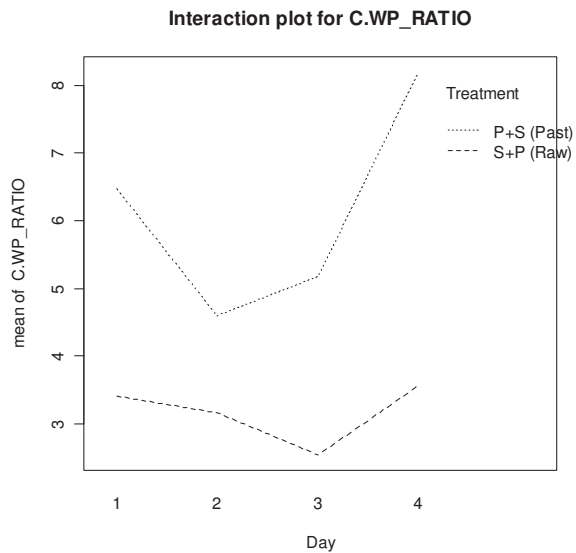

Figure 5-4 continued. Figure continued on next page.

WHEY_PROT



C.WP_RATIO



MINOR PROTEINS

HPLC_pp5

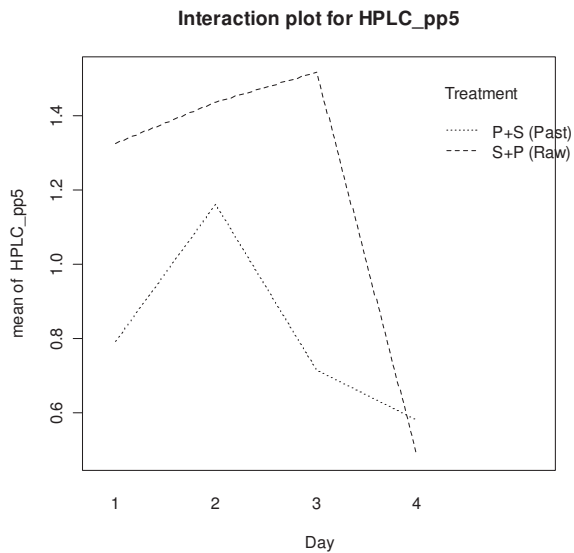

HPLC_ALA

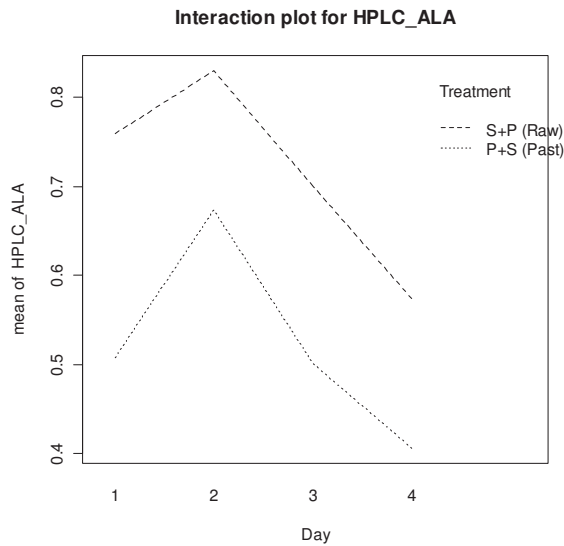
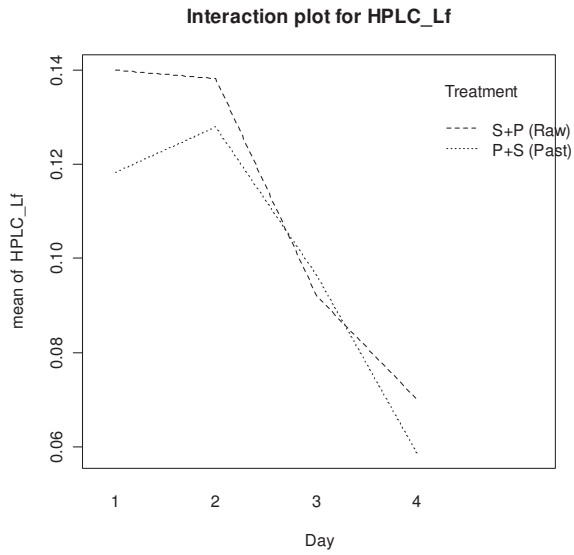
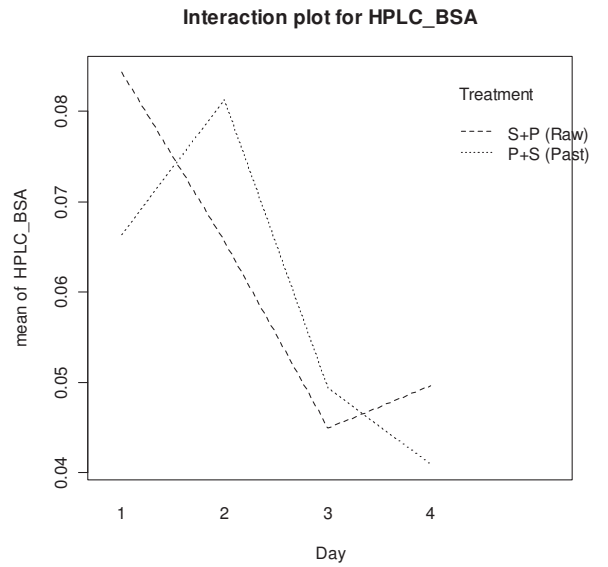

Figure 5-4 continued. Figure continued on next page.

HPLC_Lf



HPLC_BSA



HPLC_BLG

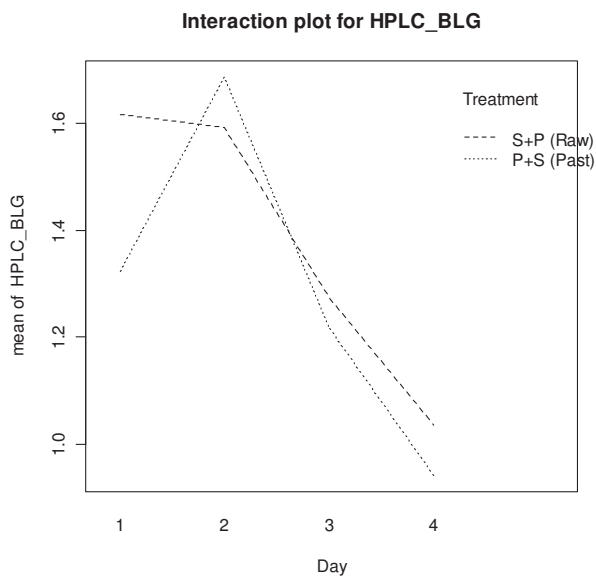

HPLC_IgG

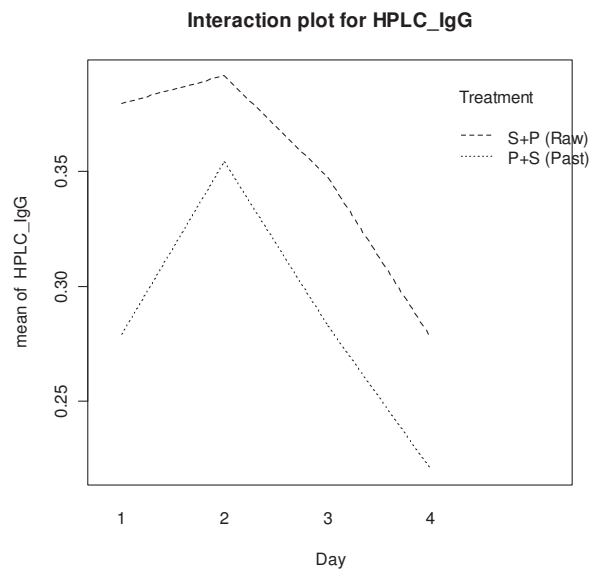
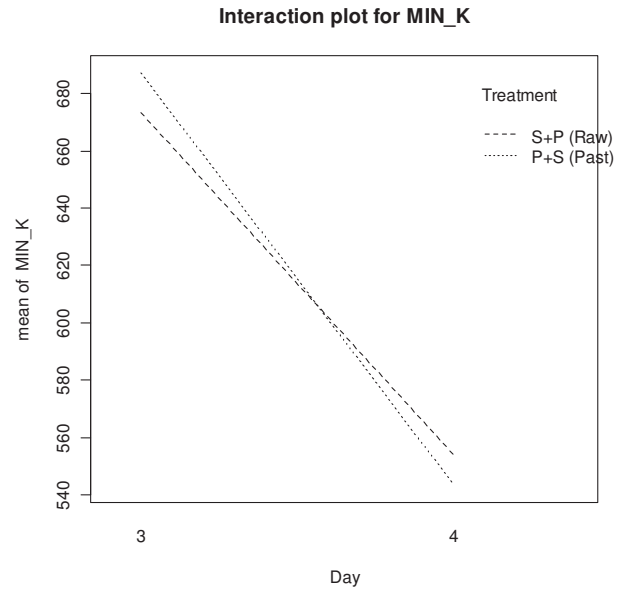
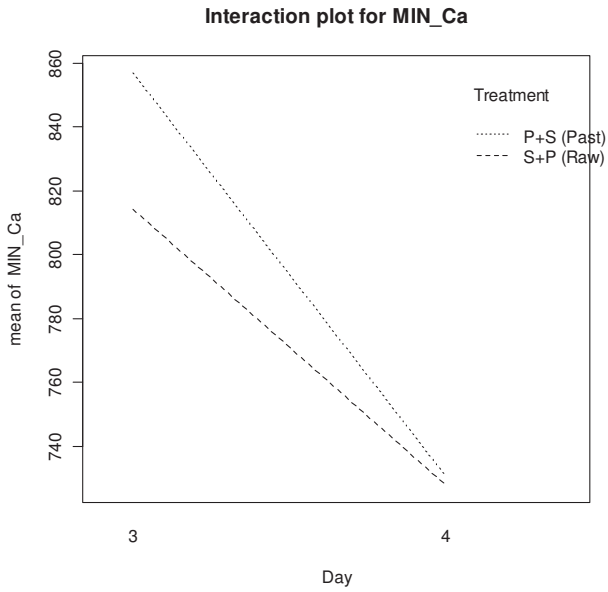

Figure 5-4 continued. Figure continued on next page.

Minerals

MIN_Ca

MIN_K



MIN_Mg

MIN_Na

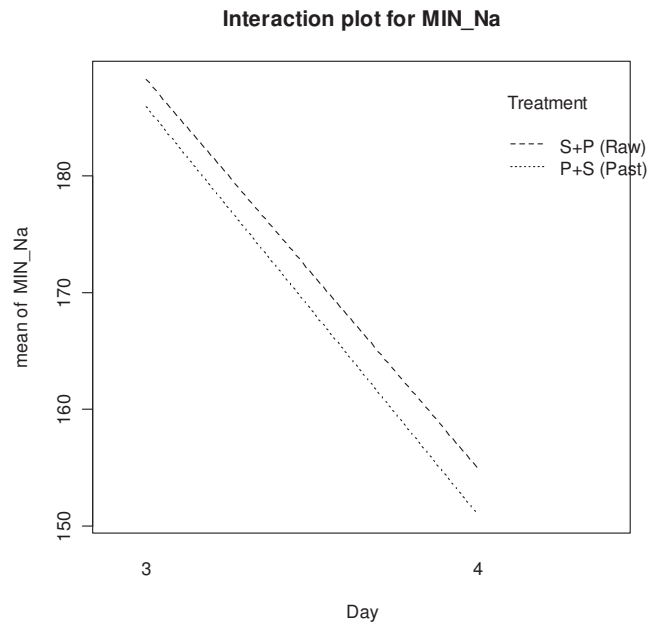
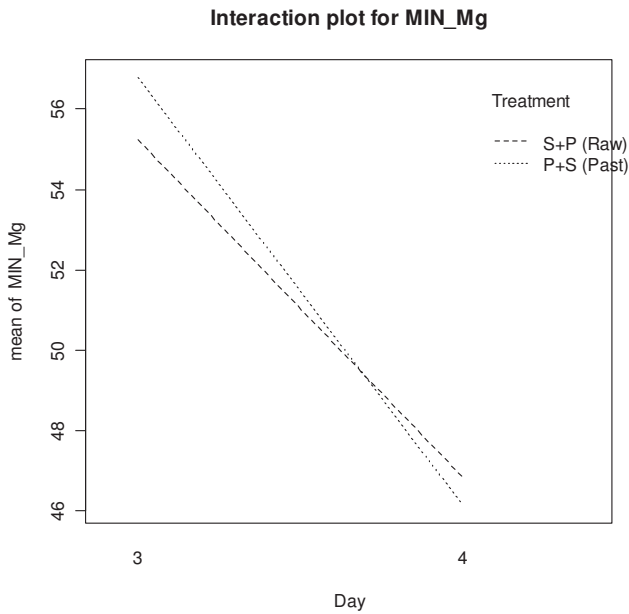

Figure 5-4 continued. Figure continued on next page.

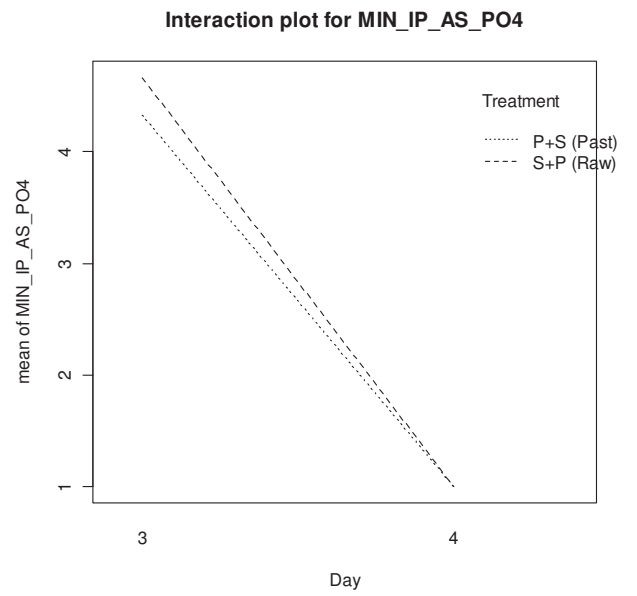
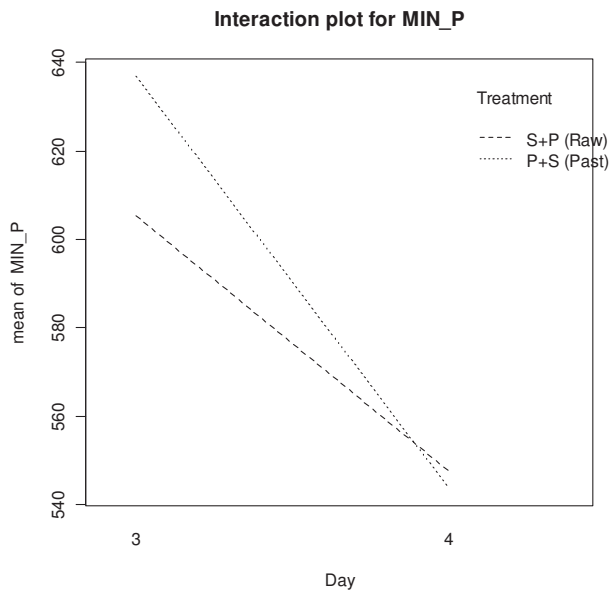

Figure 5-4 continued.

The percentage changes in the milk composition variables for the pilot plant sludges are displayed in Table 5-9.

Table 5-9 Percentage changes in milk composition variables for Pilot Plant sludge data

RESPONSE	TREATMENT = Pasteurisation
Chem analyses	
NCN	-36
NPN	-19
TN_LIQ	-4.5
FAT.RG	-12
TS	-6.2
CRUDE_PROT	-4.5
TRUE_PROT	-3.5
CASEIN	8.1
WHEY_PROT	-40
C.WP_RATIO	93
Minor proteins	
HPLC_pp5	-32
HPLC_ALA	-27
HPLC_LF	-8.9
HPLC_BSA	-2.7
HPLC_BLG	-6.4
HPLC_IgG	-19
Minerals	
MIN_Ca	3
MIN_K	0.27
MIN_Mg	0.85
MIN_Na	-1.8
MIN_P	2.4
MIN_IP_AS_PO4	-5.9

Note :

Table entries are **highlighted** as being significant **absolute** changes when
The factor (TREATMENT) is statistically significant (p-value < 0.05)

AND

The interaction with DAY is not significant

OR

The interaction with DAY is significant but is not **cross-over**

A **cross-over** interaction is one in which the two lines intersect. **Significant** entries with **cross-over** are **highlighted**.

The Tukey confidence interval plots for PP sludge responses comparing the effects of DAY and TEMP are shown in Figure 5-5.

NCN

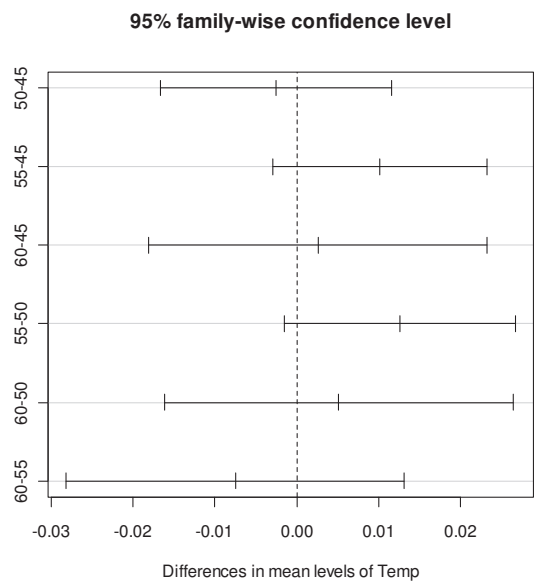
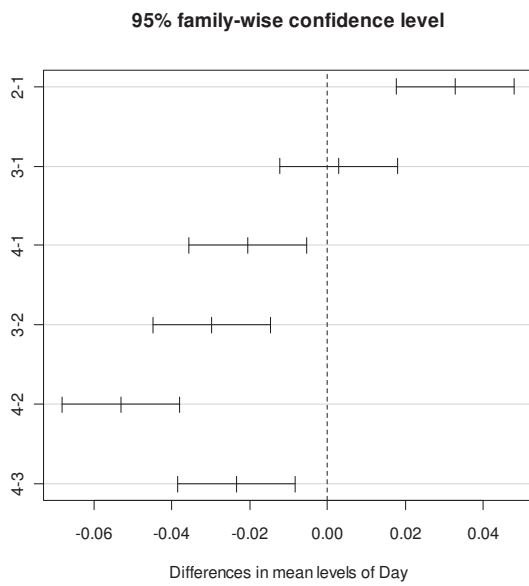

NPN

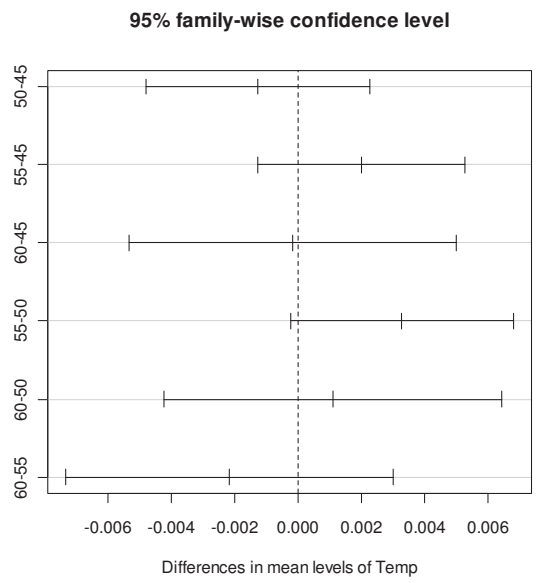
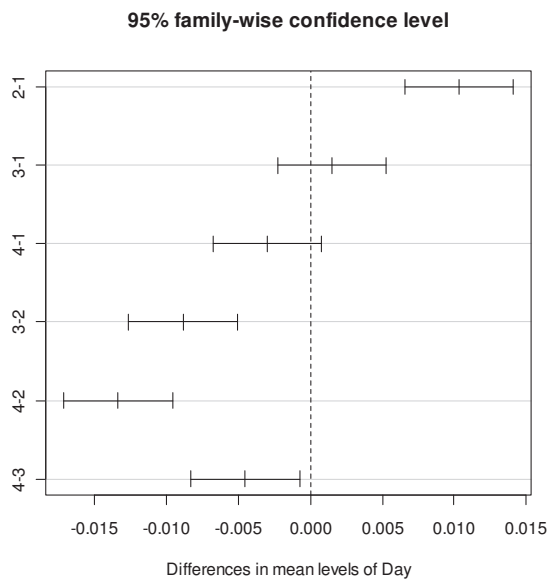
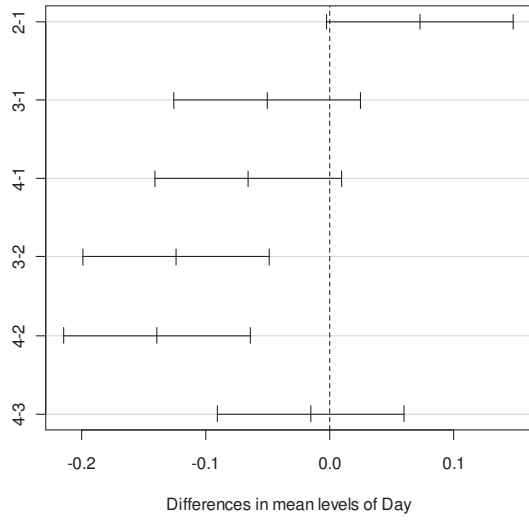

Figure 5-5 Tukey confidence interval plots for Pilot Plant sludge responses comparing DAY and TEMP effects. Figure continued on next page.

TN_LIQ

95% family-wise confidence level



95% family-wise confidence level

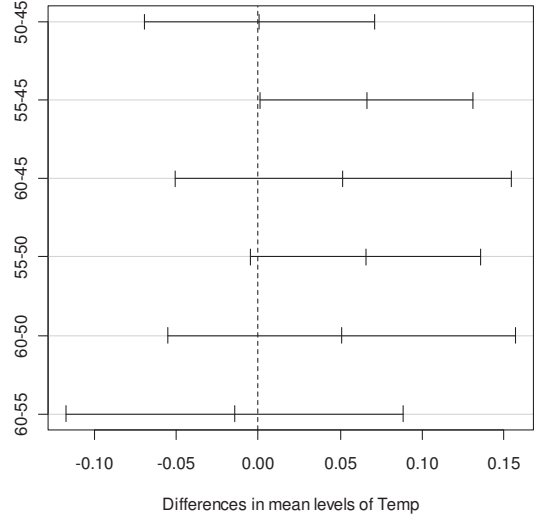

TS

95% family-wise confidence level

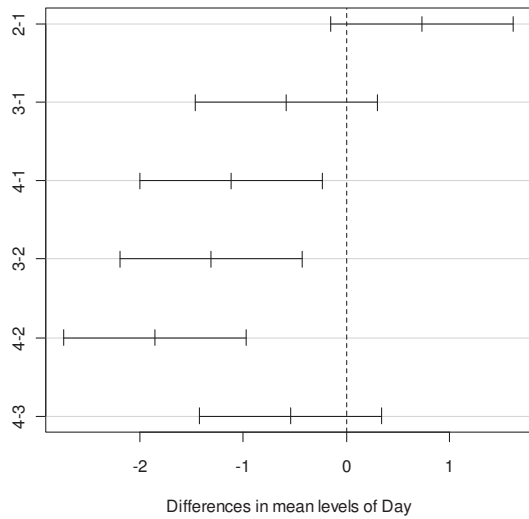

95% family-wise confidence level

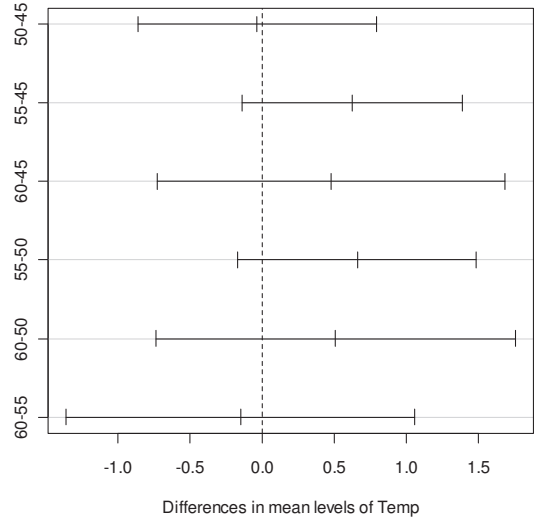
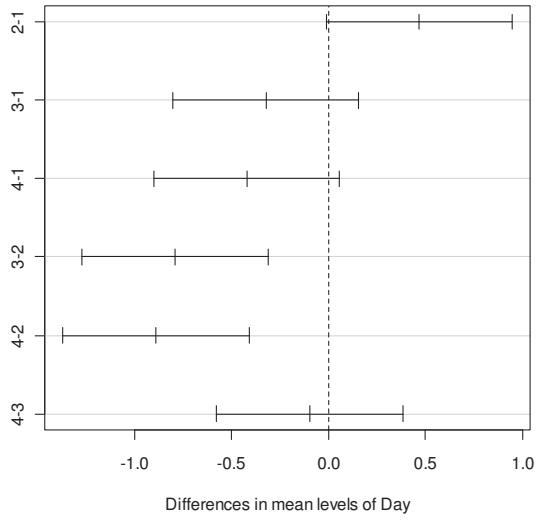

Figure 5-5 continued. Figure continued on next page.

CRUDE_PROT

95% family-wise confidence level



95% family-wise confidence level

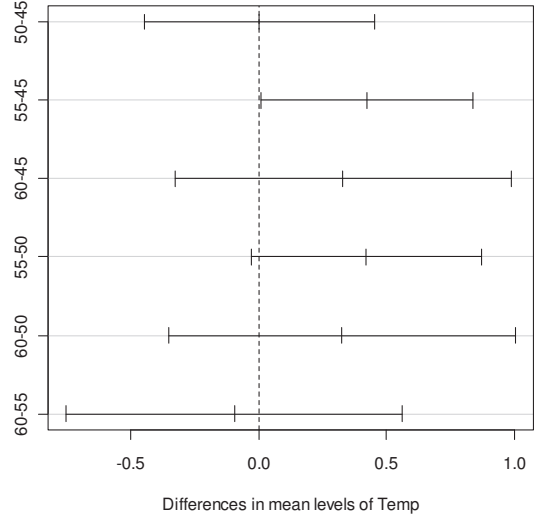

TRUE_PROT

95% family-wise confidence level

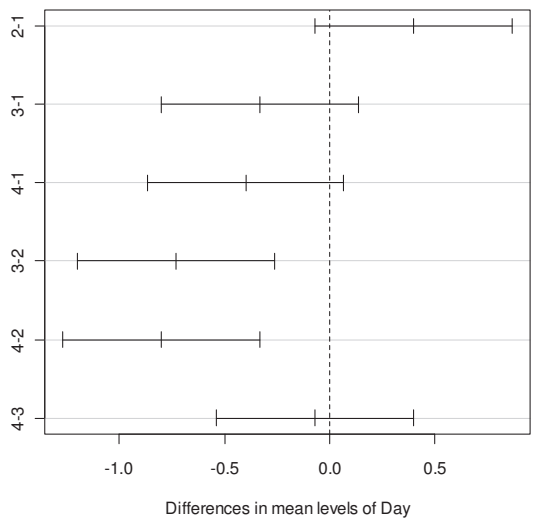

95% family-wise confidence level

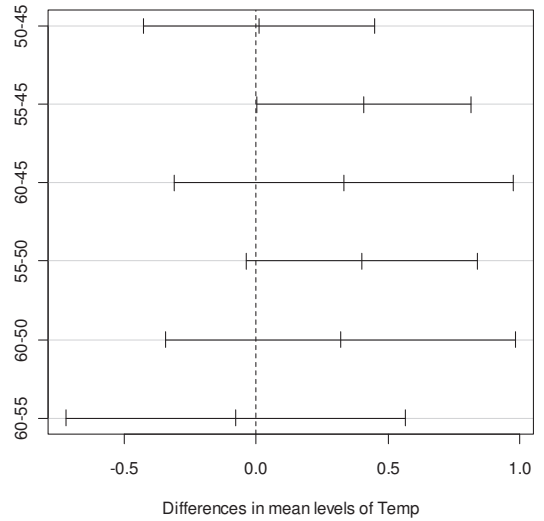
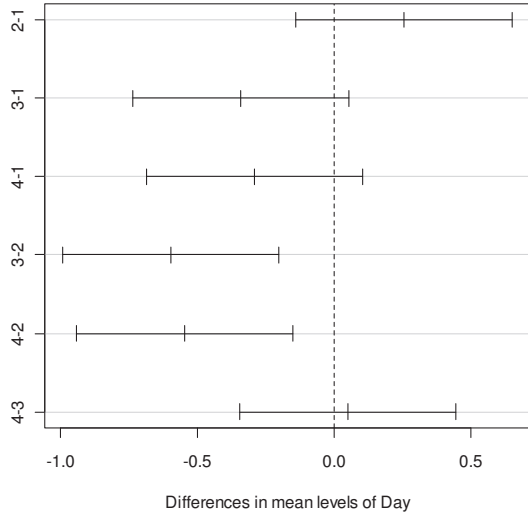

Figure 5-5 continued. Figure continued on next page.

CASEIN

95% family-wise confidence level



95% family-wise confidence level

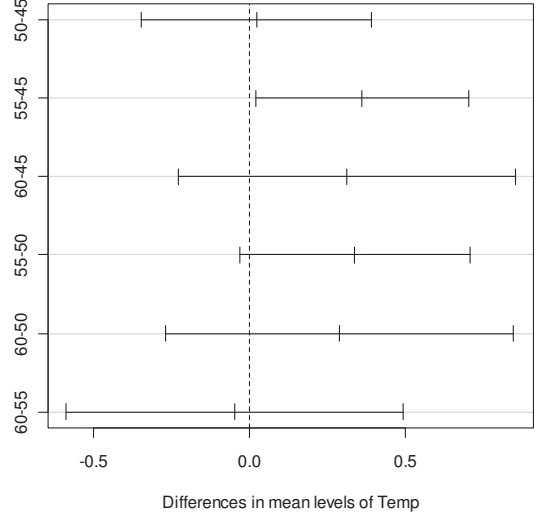

WHEY_PROT

95% family-wise confidence level

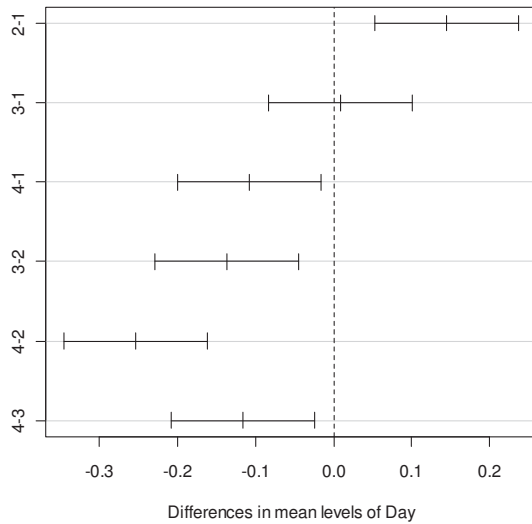

95% family-wise confidence level

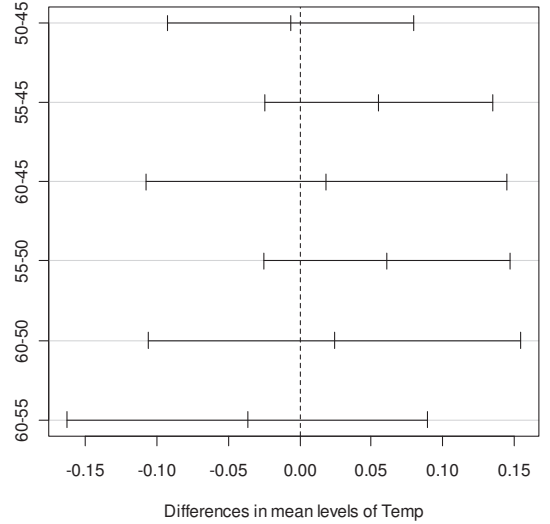
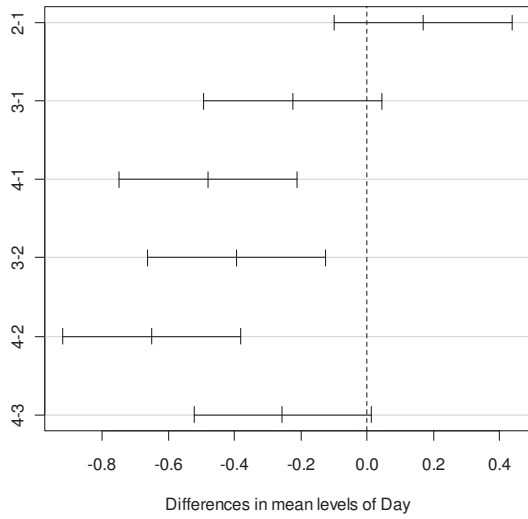
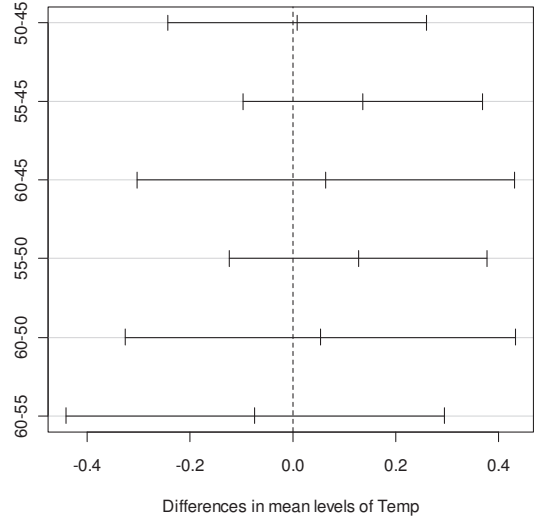

Figure 5-5 continued. Figure continued on next page.

95% family-wise confidence level



95% family-wise confidence level



MIN_Mg

95% family-wise confidence level

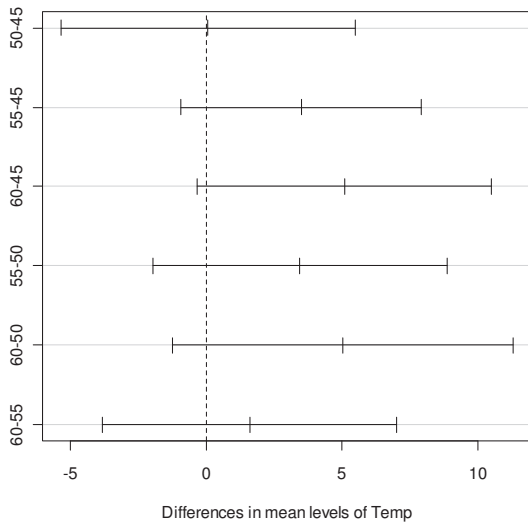

Can't do DAY as only 2 days

Figure 5-5 continued.

Notes :

Day effect consistently between Day 2 & 3, and Days 2 & 4

Temp effect only between temps 45° and 55°

The Tukey confidence interval plots for PP sludge responses showing TEMP effects are displayed in Figure 5-6.

NPN

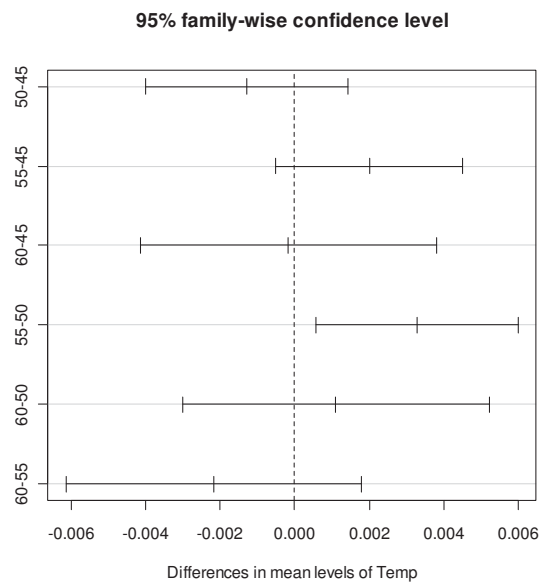

CASEIN

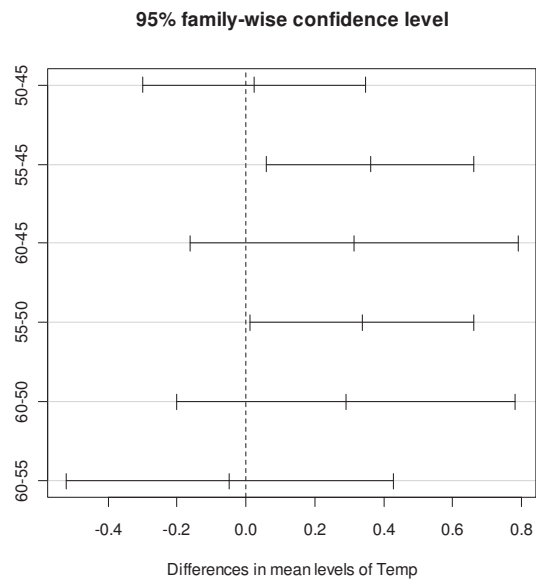

Figure 5-6 Tukey confidence interval plots for Pilot Plant sludge responses showing TEMP effects. Figure continued on next page.

MIN_Mg

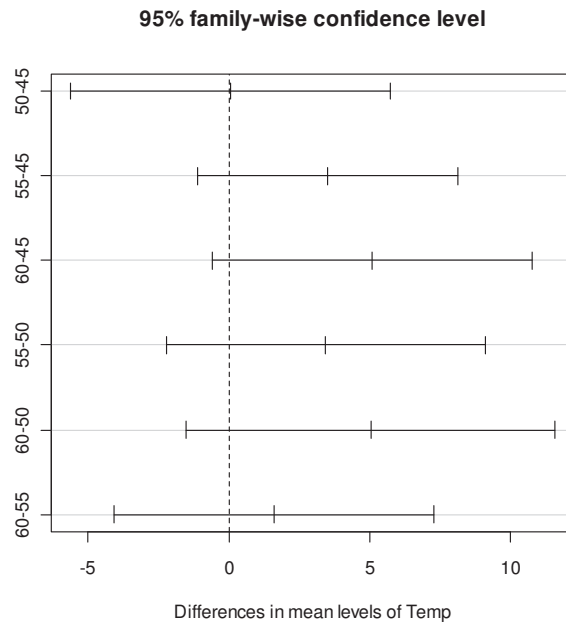

Figure 5-6 continued.

The DAY effect is significant and in some cases large for all responses, except FAT_RG. The effect of pasteurisation (PAST) and its interaction with DAY will be discussed first, and then the effect of separating temperature (TEMP) and its interaction with day.

Pasteurisation had a significant effect on a number of nitrogen and protein responses (Table 5-8).

Figure 5-4 and Table 5-9 show that pasteurisation caused a large drop in the sludge total whey protein (WHEY_PROT) content, corresponding to large decreases in the individual whey proteins HPLC_pp5, HPLC_Ala and HPLC_IgG, a large decrease in NCN, and a large increase in the casein:whey protein ratio (C:WP_RATIO). Pasteurisation did not have an effect on sludge casein (CASEIN) content.

A possible explanation for these results is that pasteurisation caused some association of whey proteins with casein micelles, resulting in the milk plasma component of the sludge being depleted in these proteins.

It is noted that there were cross-over interactions between DAY and PAST for the HPLC_pp5 and HPLC_BLG, indicating that the pasteurisation effect was obscured by the day effect.

Separating temperature had a significant effect on a number of responses. However, in most cases there was a significant DAY:TEMP interaction. This DAY:TEMP interaction could not be determined for minerals owing to a lack of data. The mineral compositional testing on the sludge samples was not performed on the samples from the first two pilot plant trials.

Tukey plots comparing variability in responses with DAY, and variation in responses with TEMP are shown in Figure 5-5 for responses for which there was a significant temperature effect. The left-hand plots show pair-wise comparisons between days, and the right-hand plots pair-wise comparisons between separating temperatures.

The x-axis of each plot shows negative and positive values of the mean difference in the response value (in the appropriate units). Mean differences were found by averaging DAY effects across separating temperatures and order of P and S, and averaging TEMP effects and order of P and S across DAYS. The y-axis indicates pairs of DAYS or pairs of TEMPs. For each pair, the mean difference in response and its confidence interval are shown on the plot.

A confidence interval that does not intersect the vertical dashed line at difference = 0.00 indicates that the difference (either positive or negative) was significant. Intersection indicates that the difference was not significant.

For example, for NCN, the mean response (NCN concentration in sludge) on DAY 3 minus the mean response on DAY 2 (= 3-2) was -0.03 (% w/w). As the confidence interval for this difference does not include the value zero, the difference was significant. Similarly, the difference between DAY 2 and DAY 1 (day 2 value minus day 1 value) was positive and significant, while the difference between DAY 3 and DAY 1 was not significant.

The Tukey plots show, overall, that variation in responses due to DAY was much greater than that due to separating temperature. They also indicate that the most consistently significant differences between days were between DAYS 2 and 3 and between DAYS 2 and 4, and that the most consistently significant difference in the

separating temperature effect was that between 45 °C and 55 °C. Essentially, the day to day variations in sludge composition outweighed the effects of separating temperature.

There were significant separating temperature-only effects. These are shown in the Tukey plots in Figure 5-6. For NPN, there was a significant difference between 50 °C and 55 °C, and for casein between 45 °C and 55 °C, and between 50 °C and 55 °C. For Min_Mg, the ANOVA indicated a significant effect of separating temperature, but Tukey's test could not determine where this difference was; the test is a conservative one.

5.2 Pilot plant trials - General discussion and conclusions

The pilot plant trial results are discussed in terms of the DAY (milk batch) effect for whole milk, skim milk, cream, and sludge, the effects of pasteurisation, the effects of separating temperature, and lastly, the effects of the order of pasteurisation and separation (sections 5.2.1 to 5.2.5). Conclusions are presented in section 5.4.

It is noted again here that chemical and other analyses of the A and B samples of process streams (samples taken at two different times during an experimental run) yielded well-replicated values of response variables. This allows confidence to be placed in the results presented here.

5.2.1 DAY (batch) effect: whole milk

The DAY (milk batch) effect was significant for most, though not all, of the principal responses (*Chemical, Minor Proteins, and PSD variables*). This effect was determined by averaging the responses for raw and pasteurised whole milk (from the P+S configuration). As pasteurisation was shown to have an insignificant effect for all responses, the DAY effect was due solely to the natural batch-to-batch variability in the composition of whole milk collected ex farm.

5.2.2 DAY (batch) effect: skim milk, cream and sludge

The DAY effect found for whole milk is reflected by the mostly highly significant DAY effects for virtually all of the skim milk, cream and sludge responses. The implications of this with respect to summarising the results of the pilot plant trials are discussed in the following sections.

5.2.3 Effect of pasteurisation: skim milk, cream and sludge

Investigating the effects of pasteurisation was not a primary objective of the present study. However, it was made possible by the experimental design used in the pilot plant trials.

Skim milk

Pasteurisation had significant effects over half the responses (mainly the whey protein concentrations and related responses), and for half of these there were significant DAY:PAST interaction effects with cross-over. This lack of consistency in the pasteurisation effect over trial days suggests that the effect was relatively minor compared to batch-to-batch variation in the feed whole milk.

Cream

The pasteurisation effect was significant only for MilkoScan Protein, and there was a significant DAY:PAST interaction with cross-over. Thus, again, the DAY effect (milk batch variability) was dominant.

Sludge

Pasteurisation had significant effects on about half the sludge responses, mainly those related to whey proteins. Significant DAY:PAST interaction effects were few, and two of them (for the responses HPLC_pp5 and HPLC_BLG) exhibited cross-over. It is possible, therefore, that pasteurisation did affect the whey protein content of the sludge, but the effect was inconsistent over trial days, and no firm conclusion can be drawn.

5.2.4 Effect of separating temperature

Separating temperature had no significant effects on the skim milk and cream responses, except for SCAN_PROT in cream, and there were no DAY:TEMP interaction effects.

In the case of sludge, there were significant separating temperature effects for a number of responses (though not for minerals), and for most of these there were significant DAY:TEMP interaction effects (though none with cross-over). The Tukey plots indicate that variation with day was much greater than variation with temperature for most responses.

5.2.5 Effect of order of separation and pasteurisation

For skim milk, the effect of order, which was significant for a number of responses, was inconsistent over trial days; there was a significant DAY:ORDER interaction effect with cross-over for most responses. This suggests that batch-to-batch variability in the feed whole milk was more dominant than effects of plant configuration.

For cream, for which there was limited response data, the same conclusion can be drawn.

For sludge, the effect of order was actually the effect of pasteurisation, which is discussed above.

The pilot plant trials were set up to mimic (ideal) factory conditions, and were used as a stepping stone to the trials on the commercial plants at Fonterra Kauri.

The highly significant differences between batches of the raw material (whole milk) coming into the pilot plant on different days was expected. The analysis of effects other than DAY (batch) was conducted on the basis that the variability due to the different batches of whole milk had first to be accounted for. The ANOVA models developed describe differences due to the variability in the raw material first, and then describe the impact of the other effects: separating temperature, the order of separation and pasteurisation, and pasteurisation as such.

The first main conclusion to be drawn from the results of the pilot plant trials is that separating temperature had no significant effects, relative to the effects of batch to batch variation, on the composition of skim milk and cream, over the temperature range tested.

The second main conclusion is that the order of processing, (P+S) versus (S+P), had apparently little effect on the composition of skim milk and cream, and that, again, these effects were overshadowed by the effects of batch-to-batch variation.

The results confirm that, as expected, pasteurisation of whole milk, skim milk and cream has minimal effects on the compositions of these streams compared to effects caused by batch-to-batch variability in the raw milk.

These findings indicate that plant configuration and separating temperature used in converting raw whole milk into pasteurised skim milk and pasteurised cream can be more flexible than previously thought, and that the changeover in the New Zealand dairy industry from S+P processing to P+S processing has resulted in no adverse consequences in terms of the composition of skim milk and cream.

5.3 Fonterra Kauri Trials

Results are presented and discussed in turn for whole milk, skim milk, cream and sludge in sections 5.3.1 to 5.3.4

Conclusions, and comparisons with the Pilot Plant trial results are presented in section 5.4.

5.3.1 Fonterra Kauri Whole Milks

The Fonterra Kauri whole milk data is displayed in Appendix 10. The ANOVA data are shown in Appendix 11.

One sample each of raw whole milk and pasteurised whole milk were taken from the P+S configuration (K2) in each of the Fonterra Kauri trials, as this configuration was only sampled at one separating temperature.

A summary of the p-values from the ANOVA performed on the Kauri whole milks appears in Table 5-10.

Table 5-10 Summary of ANOVA model p-values for Fonterra Kauri whole milk data

Response	DAY	TREAT (=pasteurisation)	DAY:TREAT	% CHANGE (Raw → Past)
Chem analyses				
NCN	----	0.005691 **	----	-7.2
NPN	----	----	----	-20
MSCAN_PROT	0.01944 *	----	----	-0.47
MSCAN_FAT	0.07829 .	----	----	-0.18
MSCAN_TS	----	----	----	-0.07
CRUDE_PROT	0.01944 *	----	----	-0.47
TRUE_PROT	----	----	----	1.1
CASEIN	0.06916 .	----	----	1.3
WHEY_PROT	----	----	----	-0.77
C.WP_RATIO	----	----	----	8.3
Minerals				
11 datapoints – too few for statistics to be meaningful				
MIN_Ca	----	/	/	/
MIN_K	----	/	/	/
MIN_Mg	----	/	/	/
MIN_Na	----	/	/	/
MIN_P	----	/	/	/
MIN_IP_AS_PO4	0.01196 *	/	/	/
Minor proteins				
HPLC_pp5	----	----	----	3.4
HPLC_ALA	----	0.08512 .	----	-4
HPLC_LF	----	0.003196 **	----	-16
HPLC_BSA	----	2.182e-07 ***	----	-26
HPLC_BLG	0.075131 .	0.007376 **	----	-5.1
HPLC_IgG	----	0.000704 ***	----	-29
PSD variables				
PSD_Conc	0.002852 **	0.090168 .	----	5.8
PSD_VWMD	0.002874 **	----	0.014208 *	1.5
PSD_SSA	0.0001348 ***	----	----	-2.6
PSD_Span	0.02776 *	----	----	-9.4
PSD_Unif	0.01738 *	----	0.01067 *	3
PSD_SWMD	0.0001227 ***	----	----	1.9
PSD_D(0.1)	0.000702 ***	----	----	4
PSD_D(0.5)	0.0002886 ***	----	----	-0.93
PSD_D(0.9)	0.007261 **	----	----	-6.7

Note :

Table entries are **highlighted** as being significant **absolute** changes when

The factor (TREATMENT) is statistically significant (p-value < 0.05)

AND

The interaction with DAY is not significant

OR

The interaction with DAY is significant but is not **cross-over**

Interaction plots for the Fonterra Kauri whole milks are shown in Figure 5-7.

CHEM VARIABLES

NCN

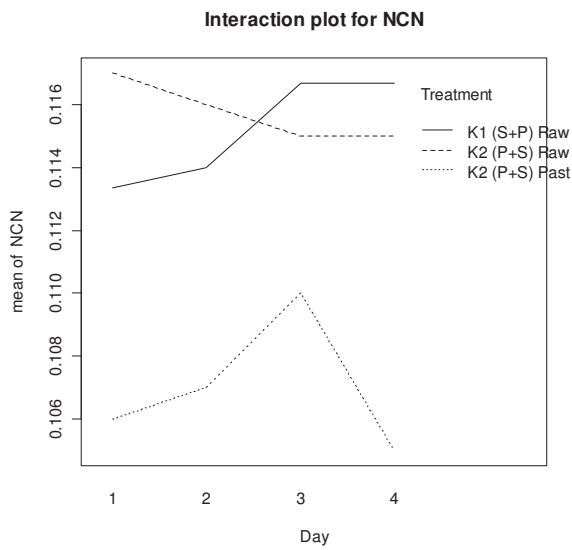

NPN

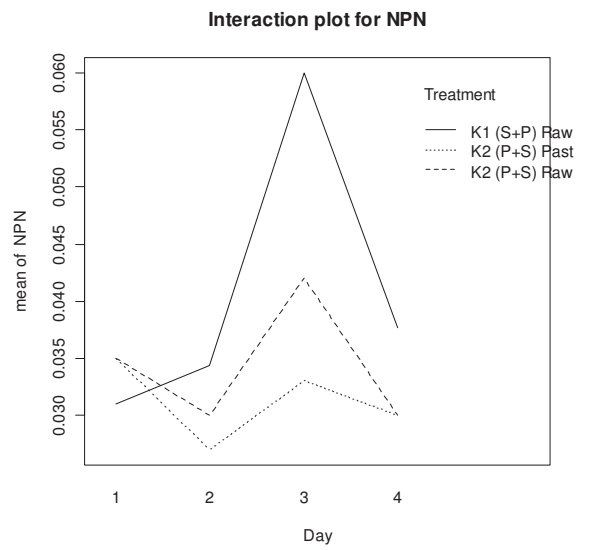

MSCAN_FAT

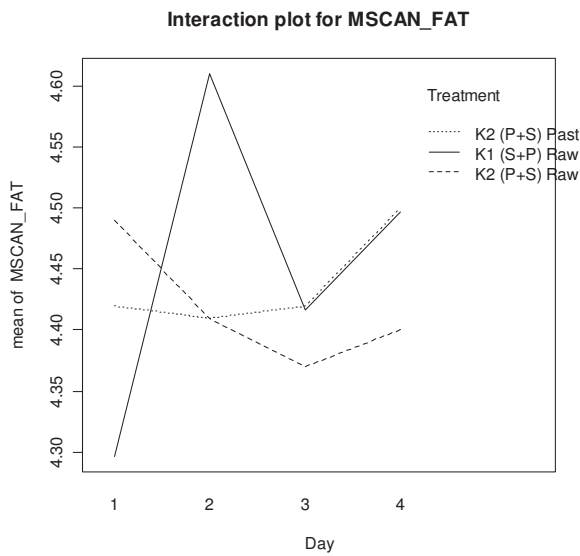

MSCAN_TS

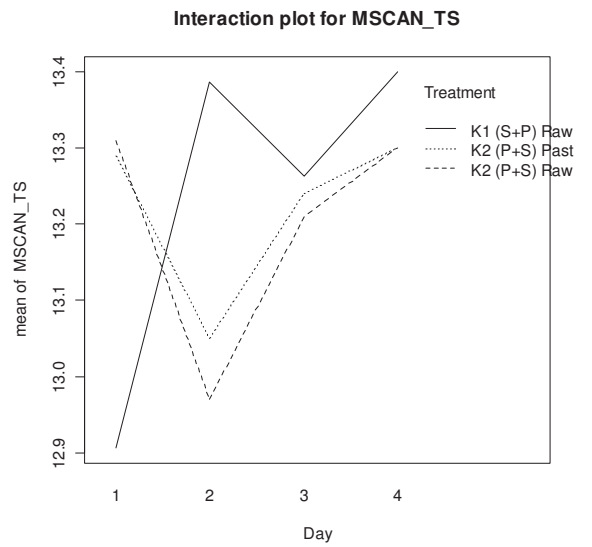
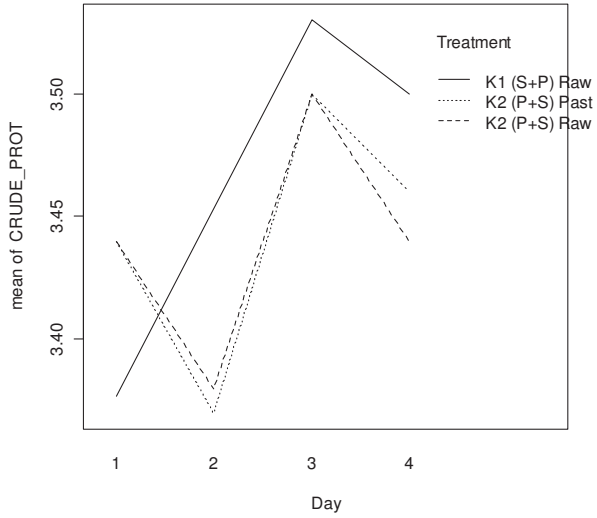

Figure 5-7 Interaction plots for Fonterra Kauri whole milk. Figure continued on next page.

CRUDE_PROT (MSCAN_PROT)

Interaction plot for CRUDE_PROT



TRUE_PROT

Interaction plot for TRUE_PROT

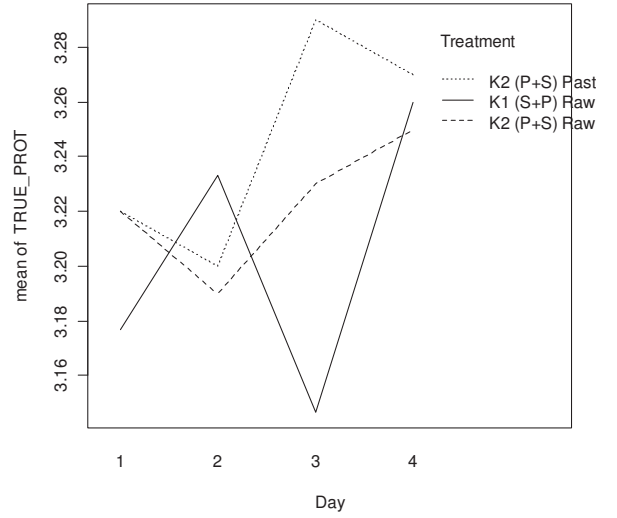

CASEIN

Interaction plot for CASEIN

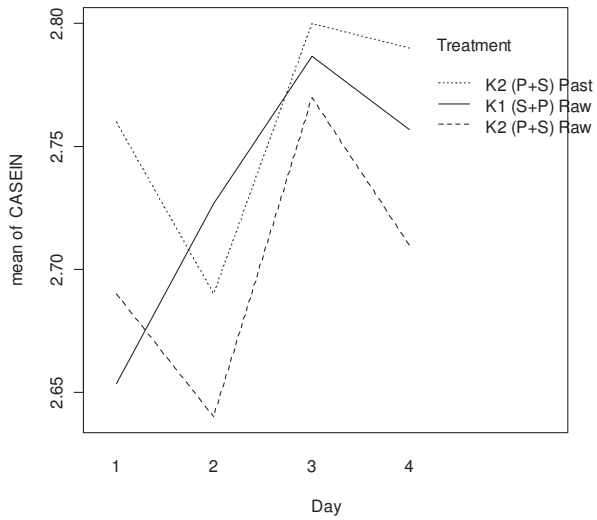

WHEY_PROT

Interaction plot for WHEY_PROT

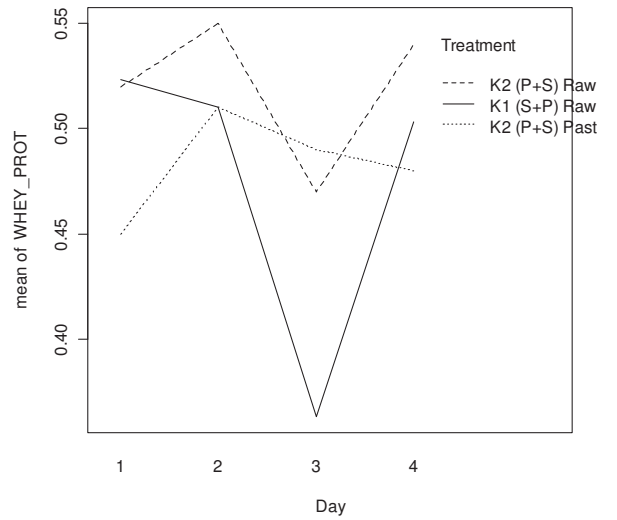
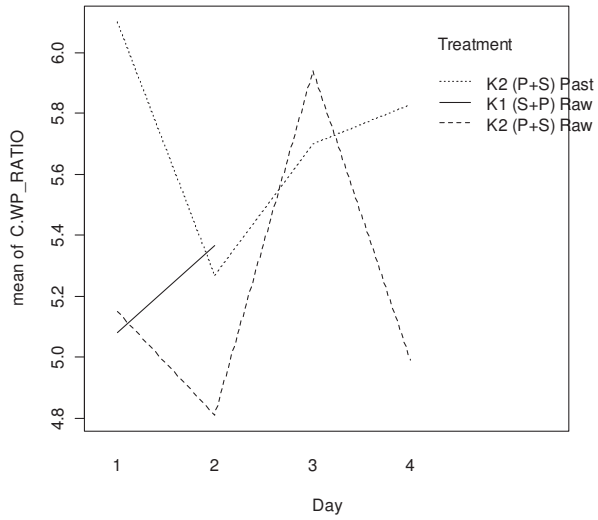

Figure 5-7 continued. Figure continued on next page.

C.WP_RATIO

Interaction plot for C.WP_RATIO



Minerals

MIN_Ca

Interaction plot for MIN_Ca

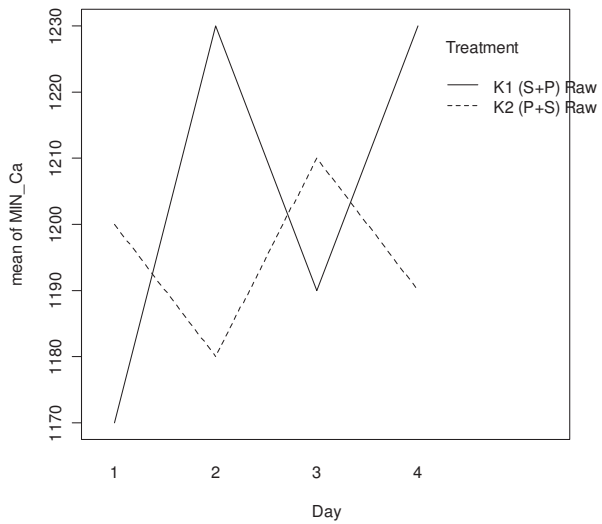

MIN_K

Interaction plot for MIN_K

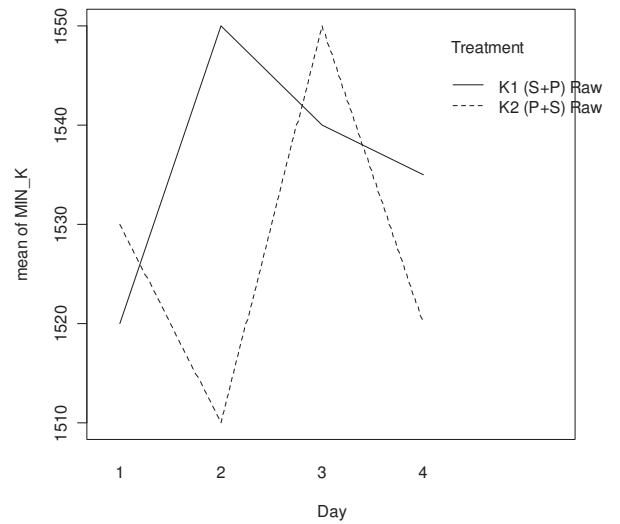
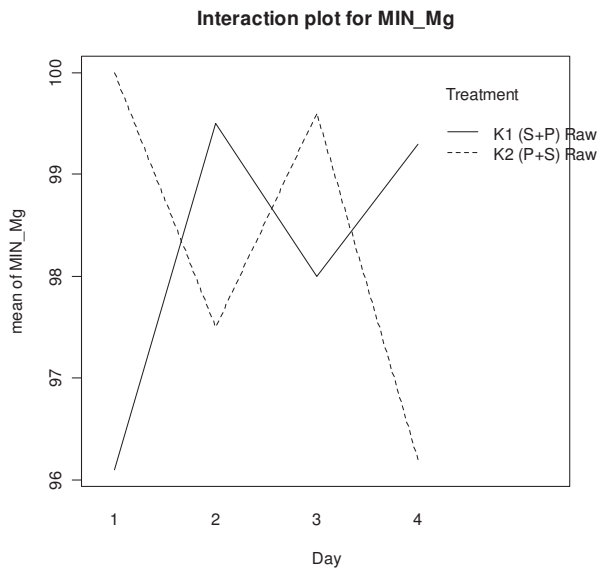
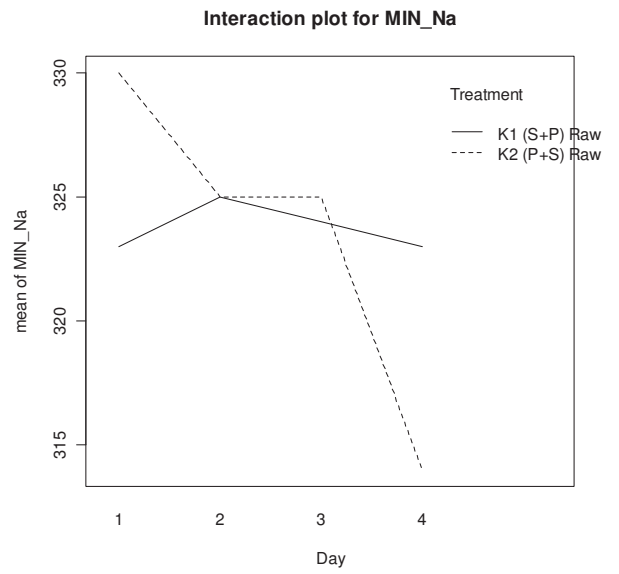

Figure 5-7 continued. Figure continued on next page.

MIN_Mg



MIN_Na



MIN_P

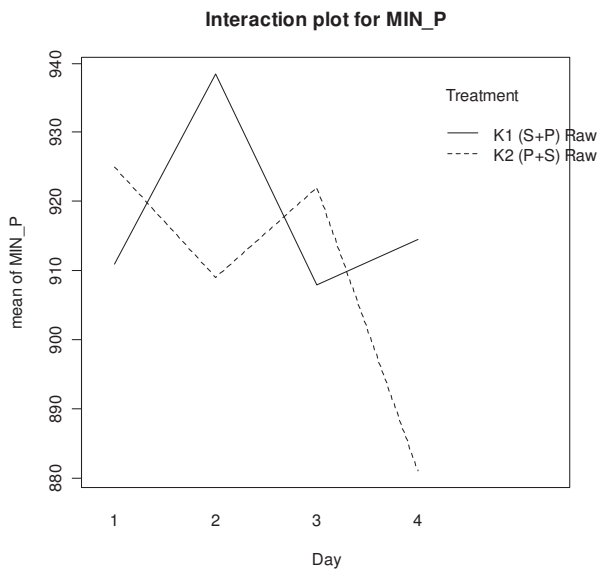

MIN_IP_AS_PO4

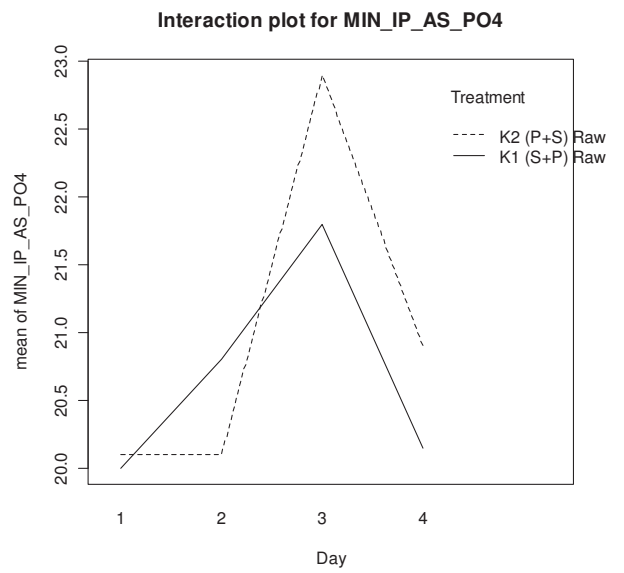
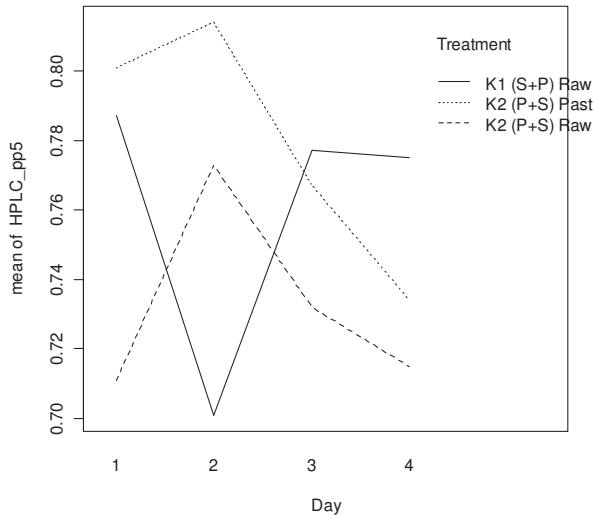

Figure 5-7 continued. Figure continued on next page.

MINOR PROTEINS

HPLC_pp5

Interaction plot for HPLC_pp5



HPLC_ALA

Interaction plot for HPLC_ALA

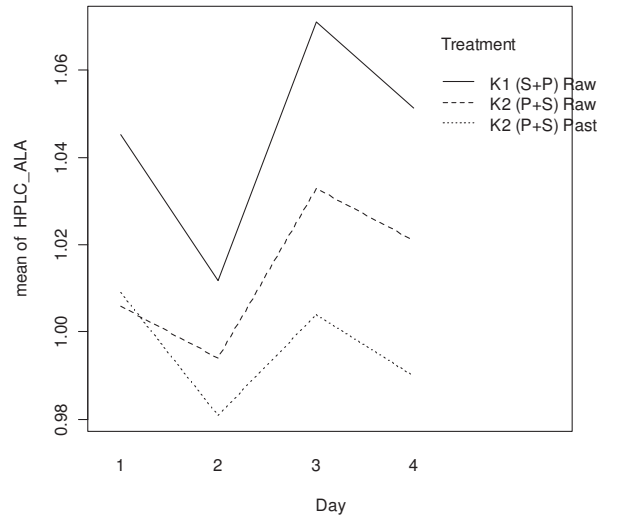

HPLC_LF

Interaction plot for HPLC_LF

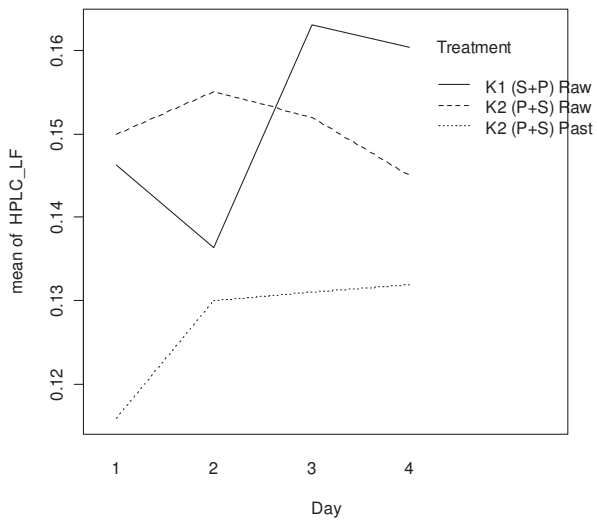

HPLC_BSA

Interaction plot for HPLC_BSA

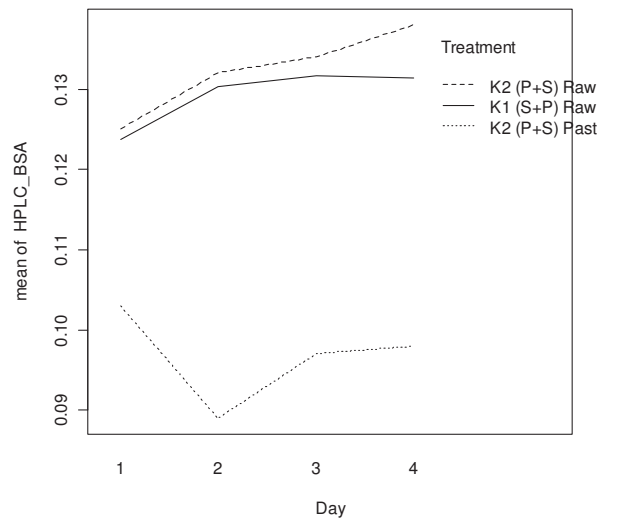
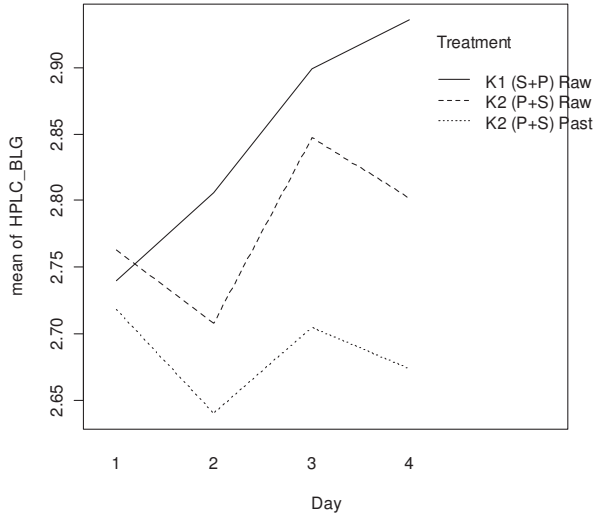

Figure 5-7 continued. Figure continued on next page.

HPLC_BLG

Interaction plot for HPLC_BLG



HPLC_IgG

Interaction plot for HPLC_IgG

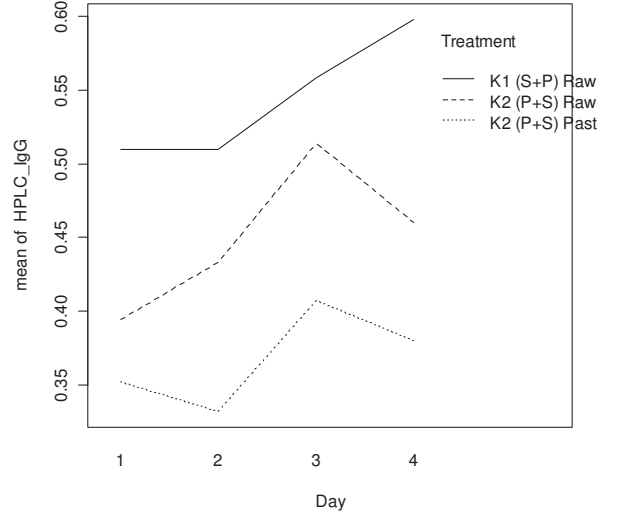

Particle size distribution

PSD_Conc

Interaction plot for PSD_Conc

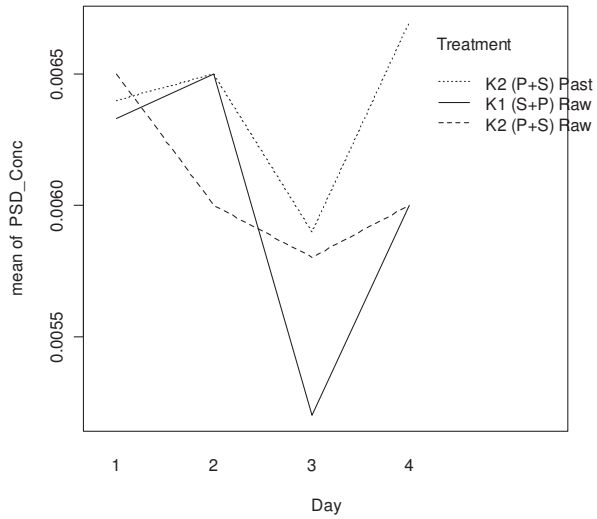

PSD_VWMD

Interaction plot for PSD_VWMD

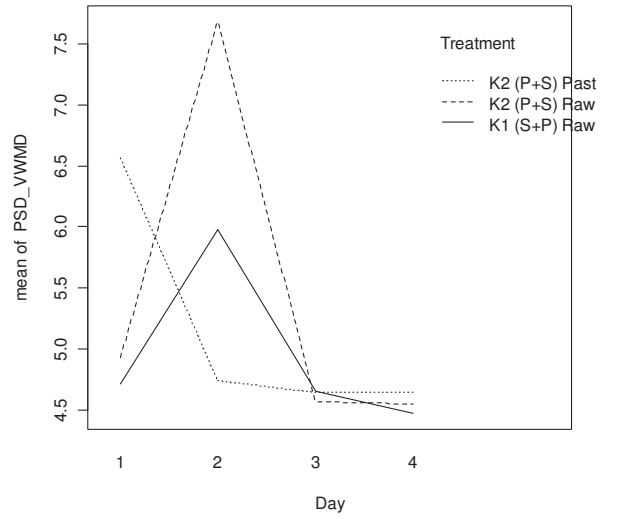
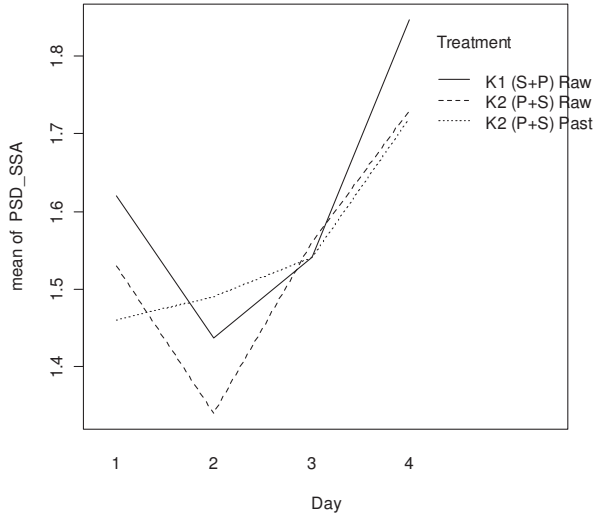

Figure 5-7 continued. Figure continued on next page.

PSD_SSA

Interaction plot for PSD_SSA



PSD_Span

Interaction plot for PSD_Span

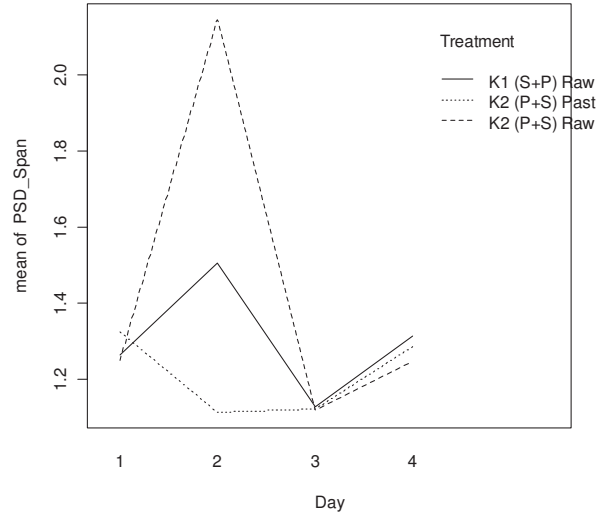

PSD_Unif

Interaction plot for PSD_Unif

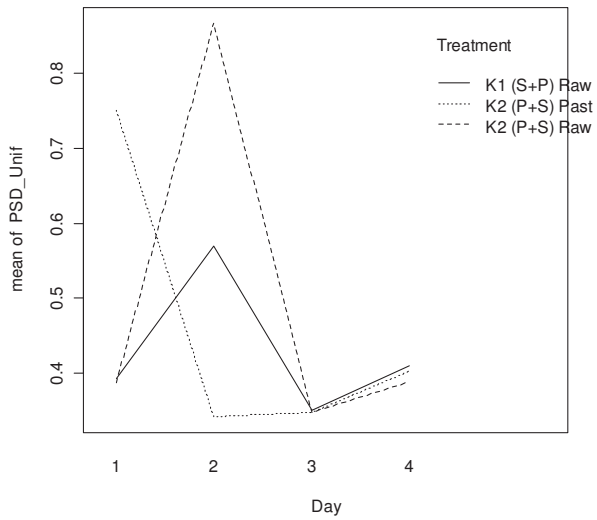

PSD_SWMD

Interaction plot for PSD_SWMD

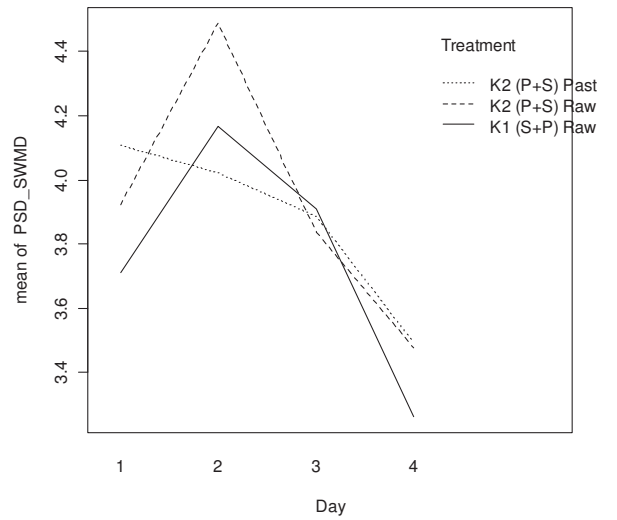
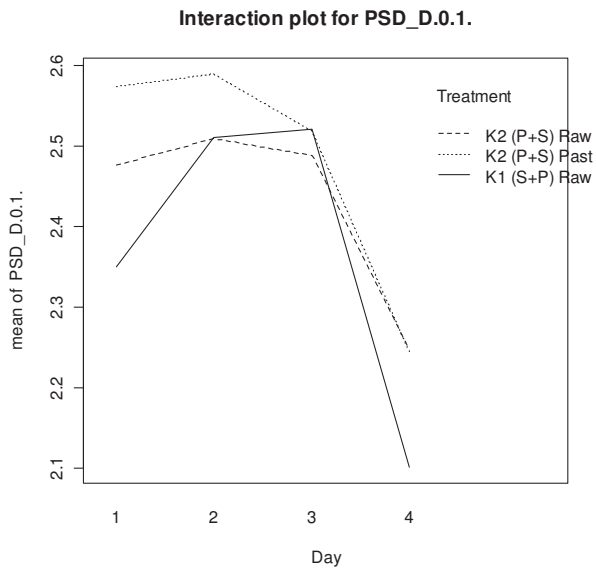
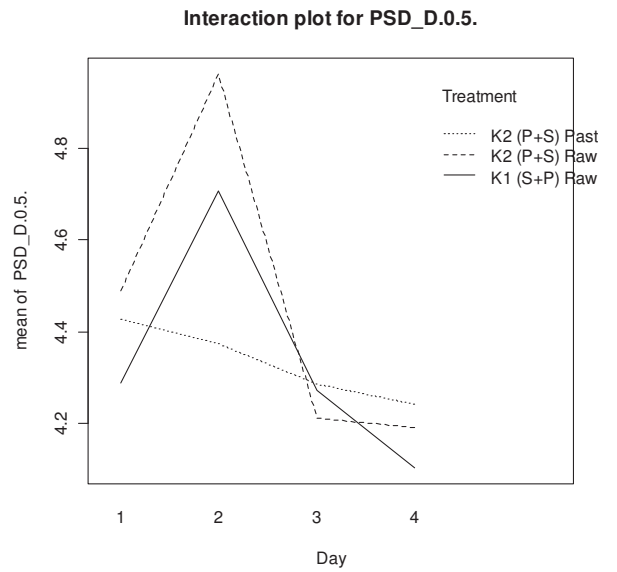

Figure 5-7 continued. Figure continued on next page.

PSD_D(0.1)



PSD_D(0.5)



PSD_D(0.9)

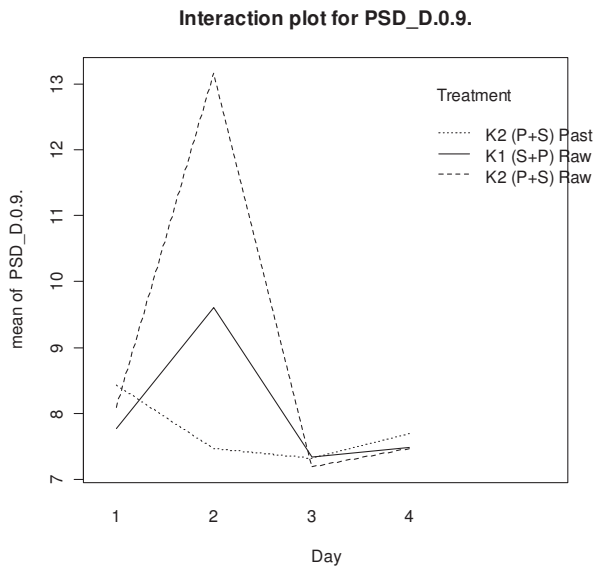

Figure 5-7 continued. Figure continued on next page.

The Tukey plots for the Fonterra Kauri Whole Milks are found in Figure 5-8.

MSCAN_PROT

CRUDE_PROT

95% family-wise confidence level

95% family-wise confidence level

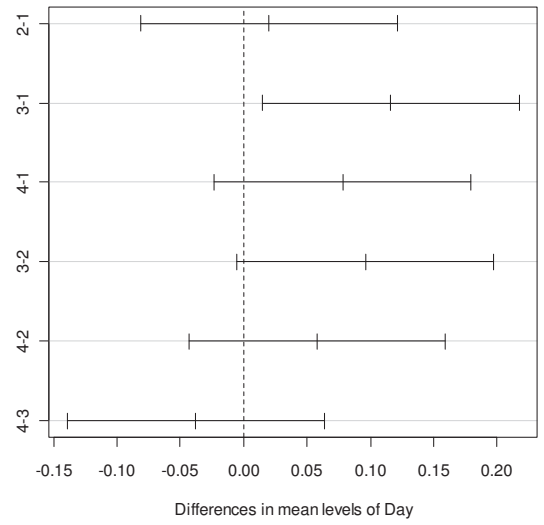
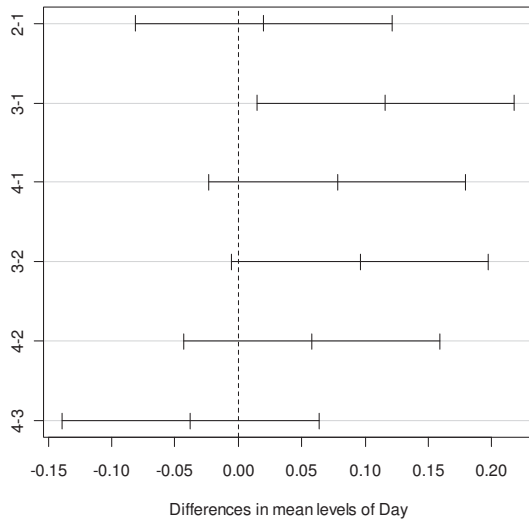

PSD_Conc

PSD_VWMD

95% family-wise confidence level

95% family-wise confidence level

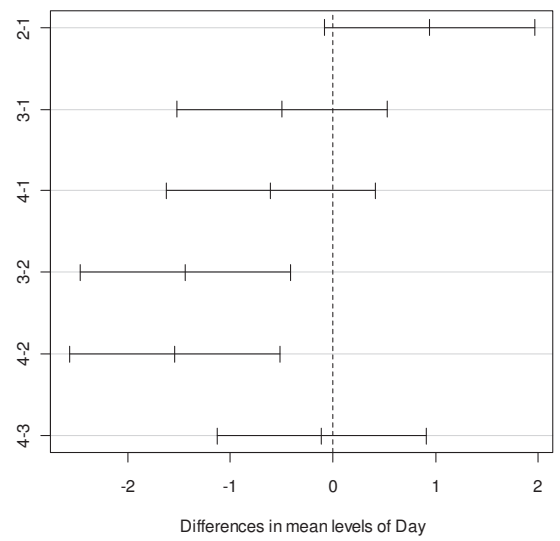
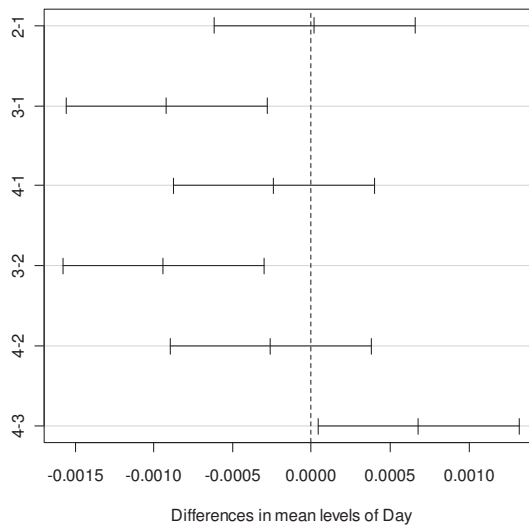
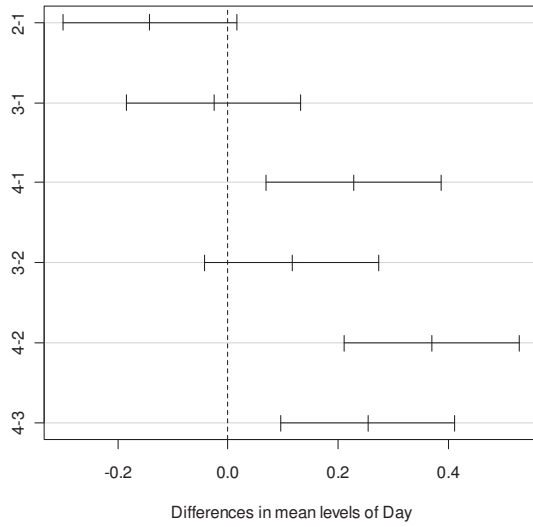

Figure 5-8 Tukey plots for Fonterra Kauri whole milk. Figure continued on next page.

PSD_SSA

PSD_Span

95% family-wise confidence level



95% family-wise confidence level

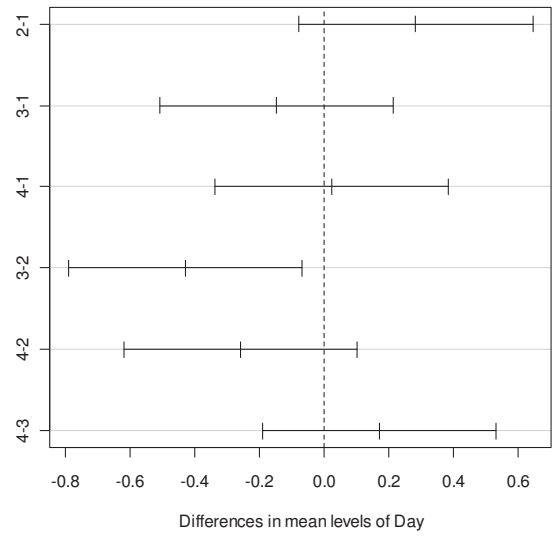

PSD_Unif

PSD_SWMD

95% family-wise confidence level

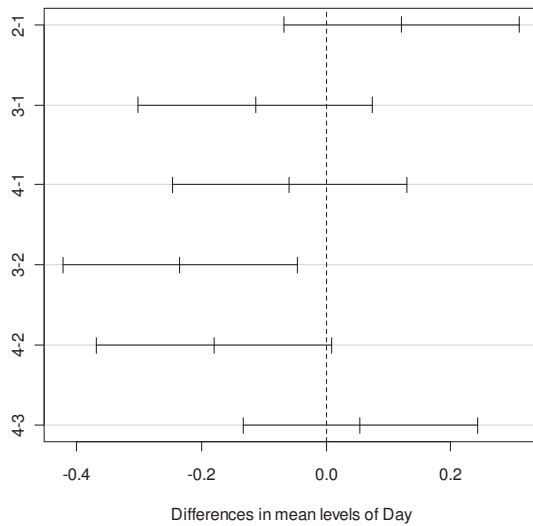

95% family-wise confidence level

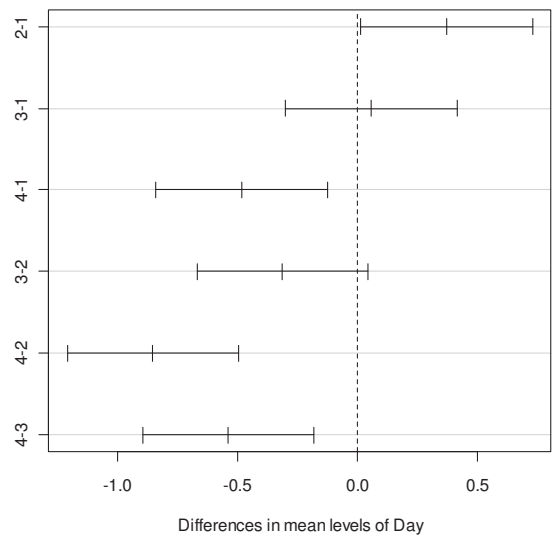
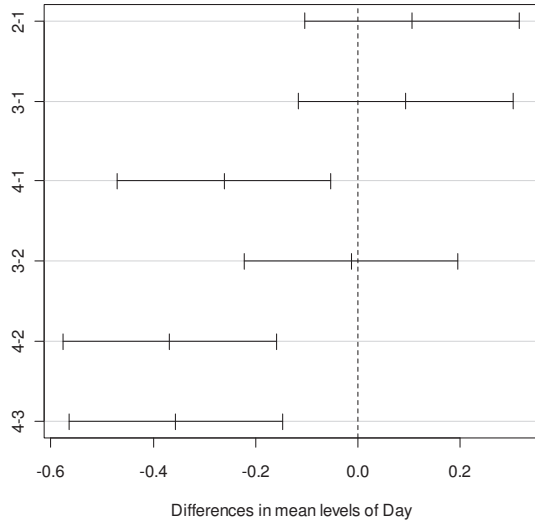

Figure 5-8 continued. Figure continued on next page.

PSD_D(0.1)

95% family-wise confidence level



PSD_D(0.5)

95% family-wise confidence level

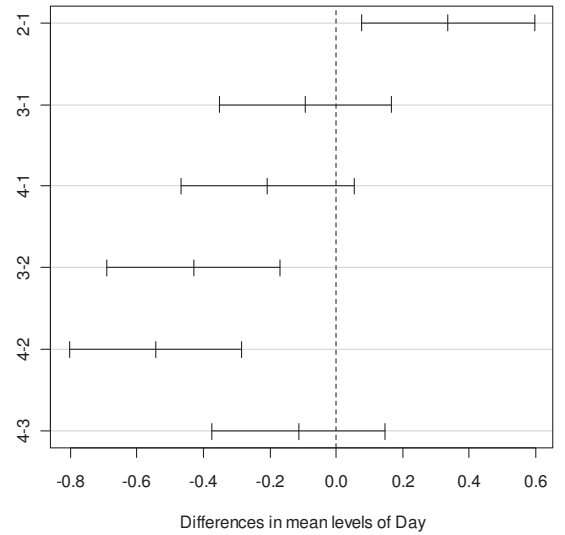

PSD_D(0.9)

95% family-wise confidence level

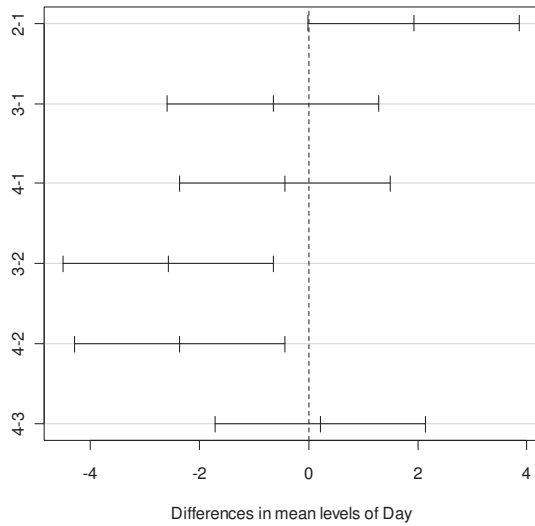

MIN_IP_AS_PO4

95% family-wise confidence level

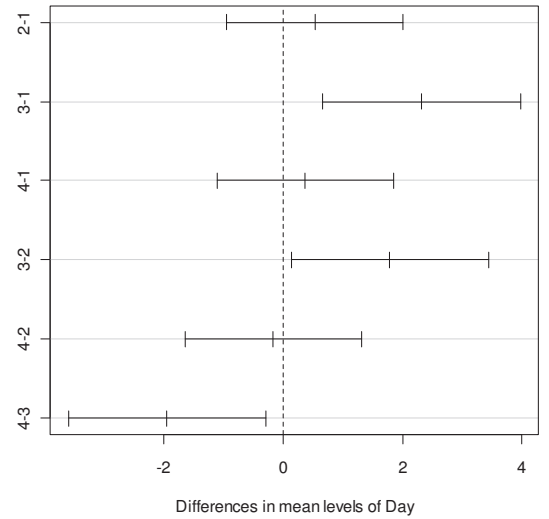

Figure 5-8 continued. Figure continued on next page.

95% family-wise confidence level

Figure 5-8 continued.

Only one sample (rather than two) was taken from each sample point in a given run.

The main factors in the ANOVA were DAY (raw milk batch), PAST (pasteurisation) and the DAY:PAST interaction. The effect of pasteurisation was assessed by comparing the mean of K1 (S+P) Raw and K2 (P+S) Raw with K2 (P+S) Past (Figure 4-2 and Figure 4-3).

All responses were tested except for minerals as measured by ICP-OES, for which there were insufficient data. This is due to not all of the whole milk samples being subjected to the analyses, in order to reduce costs for the trial.

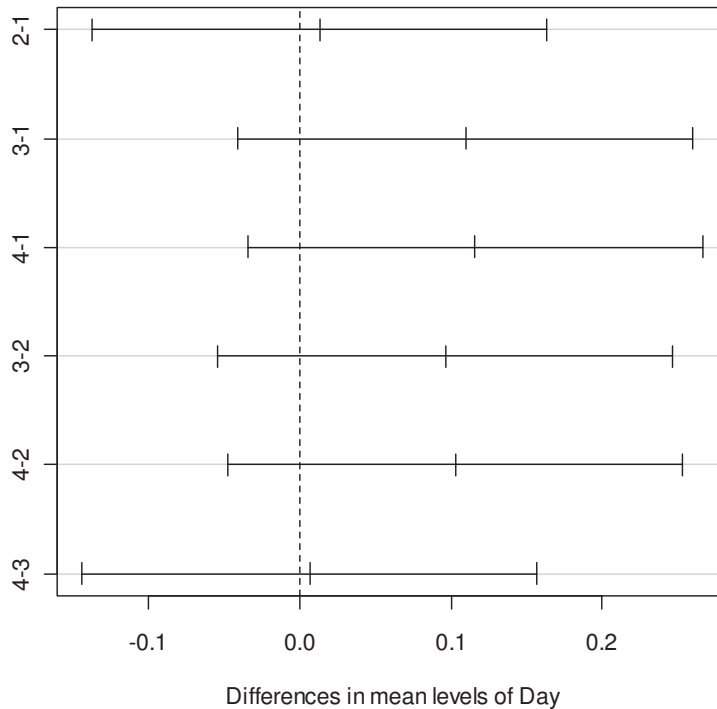
There were some significant DAY (milk batch) effects, but these were consistent only for the PSD response variables (Table 5-10).

Pasteurisation had significant effects only on the whey proteins (and, correspondingly, on NCN) (Table 5-10). The % CHANGE column in Table 5-10 and the interaction plots (Figure 5-7) show that most of these effects were significant and negative: pasteurisation caused significant losses of undenatured whey proteins. This is in contrast to the results of the Pilot Plant trials, which show that pasteurisation had no significant effects on the whole milk composition.

For some responses for which there was a significant DAY effect, there were significant pair-wise differences between DAYS. These are shown in the Tukey plots in Figure 5-8.

It is noted that for the whole milk, there was a significant DAY effect for both MIN_IP_AS_PO4 and CASEIN. Given the structure of the casein micelle, this concomitance lends credence to the data.

Microbiological results

The Kauri microbiological raw data are found in Appendix 10.

The coliform counts and the APC of the pasteurised whole milks were much lower than those of the raw whole milks.

The thermophile and thermoduric counts for the raw and pasteurised whole milks were very similar, in general.

5.3.2 Fonterra Kauri Skim Milk

The raw data (including microbiological analyses) for the Kauri skim milk is displayed in Appendix 12. The ANOVA tables for the Kauri skim data are shown in Appendix 13.

The summary ANOVA table for the Kauri skim milks is shown in Table 5-11.

Table 5-11 Summary of ANOVA model p-values for Fonterra Kauri skim milk data

Response	DAY	PAST	PAST:TEMP	% CHANGE (Raw → Past)
Chem analyses				
NCN	----	0.03455 *	0.07457 .	-4.9
NPN	----	----	----	-4.3
TN_LIQ	0.04771 *	----	----	-0.81
FAT_RG	----	----	----	15
TS	0.07446 .	----	----	-0.16
CRUDE_PROT	0.04528 *	----	----	-0.81
TRUE_PROT	0.02246 *	----	0.04167 *	-0.59
CASEIN	0.02141 *	----	----	0.31
WHEY_PROT	----	----	0.01148 *	-5.2
C.WP_RATIO	----	----	0.01454 *	4.3
Minerals				
MIN_Ca	----	----	----	-0.82
MIN_K	----	----	----	-0.12
MIN_Mg	----	----	----	-0.34
MIN_Na	----	----	----	-0.033
MIN_TP	----	----	0.02853 *	-0.96
MIN_IP_AS_PO4	0.01995 *	0.06943 .	----	-4.3
Minor proteins				
HPLC_pp5	----	0.07017 .	0.09358 .	-3.4
HPLC_ALA	0.03369 *	9.826e-05 ***	0.04951 *	-4.5
HPLC_LF	0.01616 *	5.158e-05 ***	0.03024 *	-18
HPLC_BSA	----	1.803e-05 ***	----	-24
HPLC_BLG	0.01142 *	5.371e-05 ***	----	-6.9
HPLC_IgG	0.02901 *	1.986e-07 ***	----	-35

Significant absolute % changes are highlighted in blue.

Significant changes with cross-over effect highlighted in red.

The interaction plots for the Kauri skim milks are shown in Figure 5-9.

CHEM VARIABLES

NCN

Interaction plot for NCN

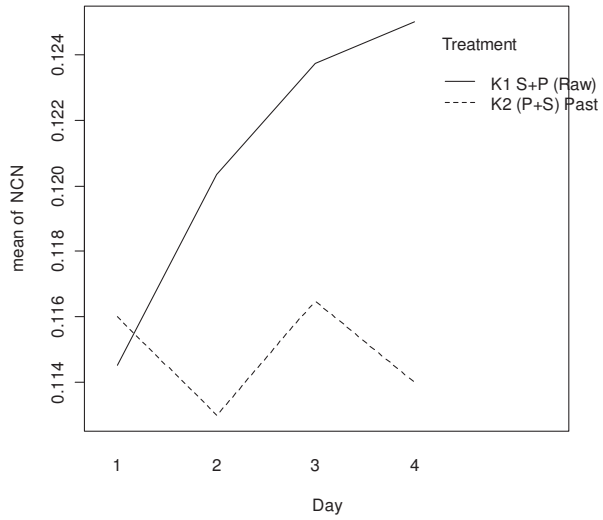

NPN

Interaction plot for NPN

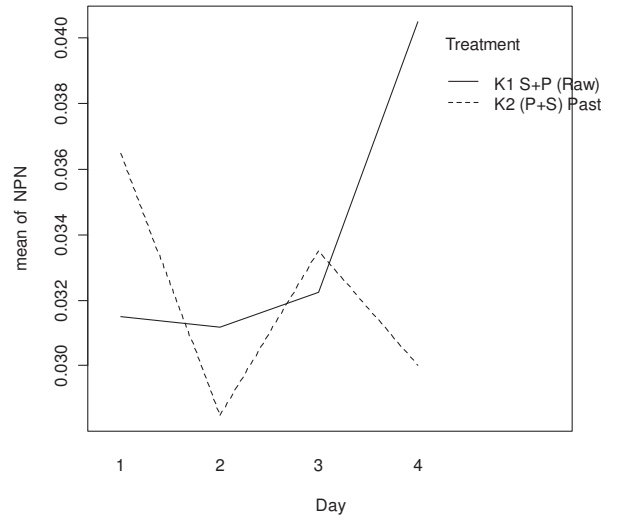

TN_LIQ

Interaction plot for TN_LIQ

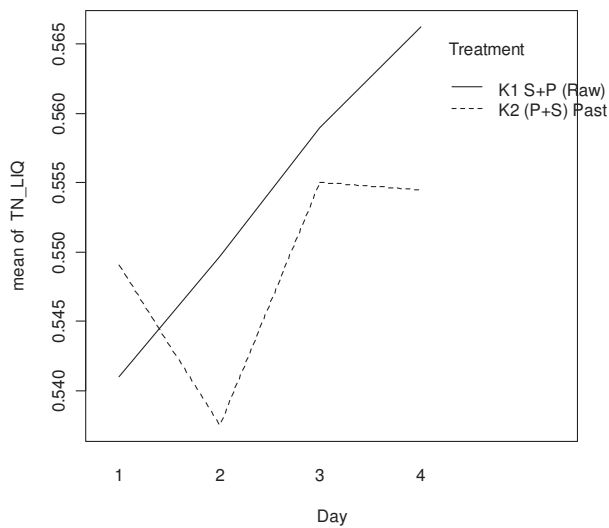

FAT_RG

Interaction plot for FAT_RG

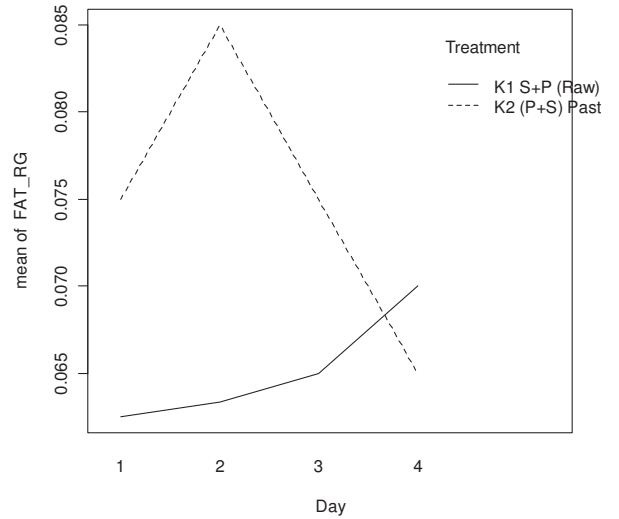
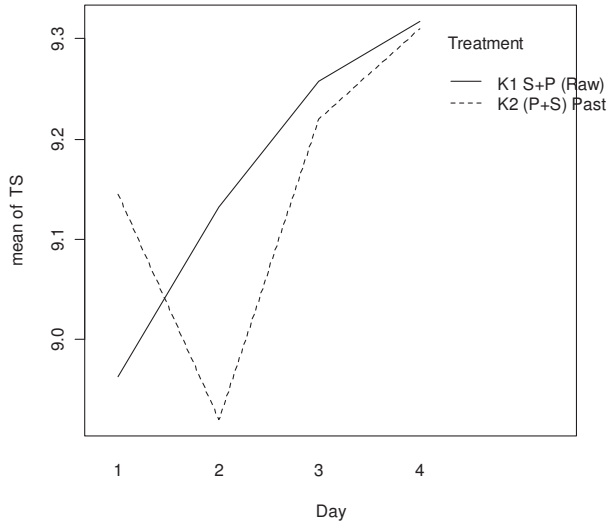

Figure 5-9 Interaction Plots for Fonterra Kauri skim milk. Figure continued on next page.

TS

Interaction plot for TS



CRUDE_PROT

Interaction plot for CRUDE_PROT

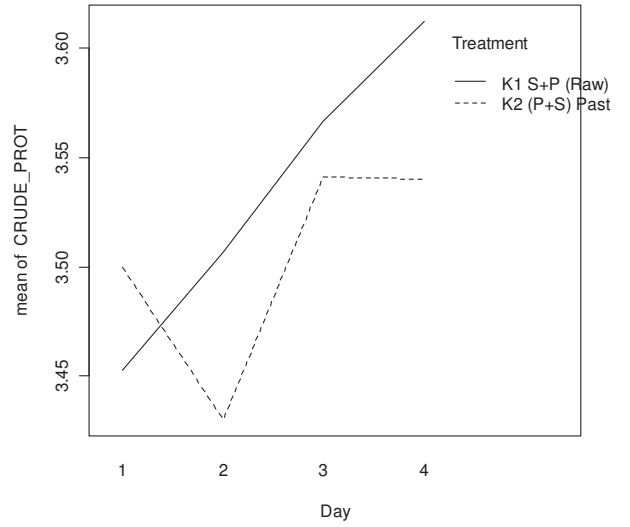

TRUE_PROT

Interaction plot for TRUE_PROT

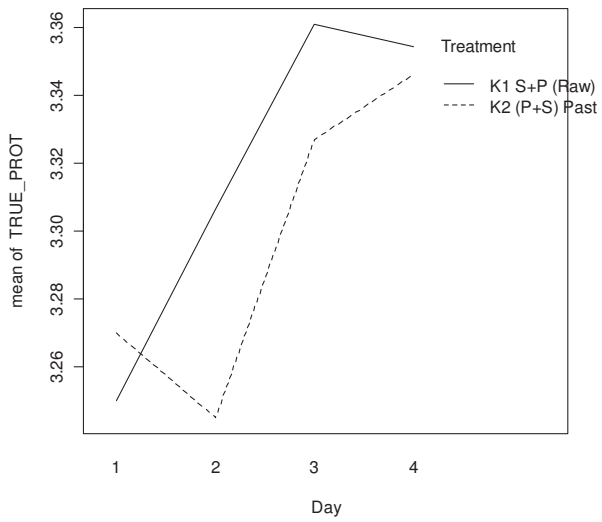

CASEIN

Interaction plot for CASEIN

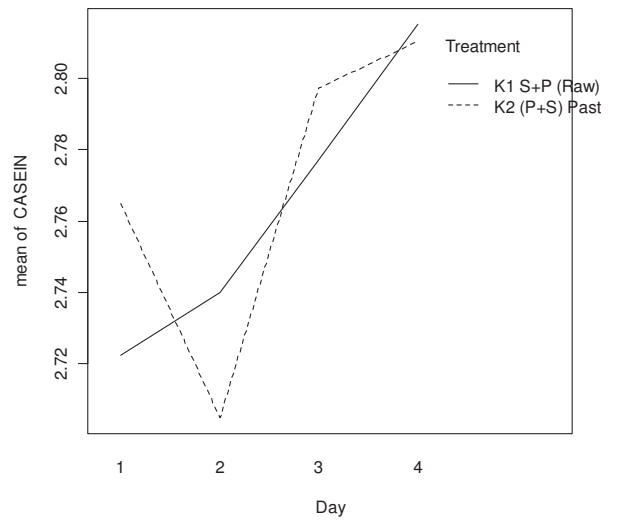
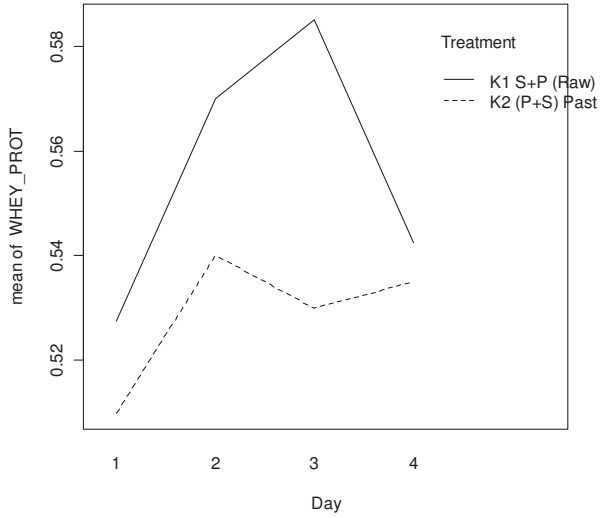

Figure 5-9 continued. Figure continued on next page.

WHEY_PROT

Interaction plot for WHEY_PROT



C.WP_RATIO

Interaction plot for C.WP_RATIO

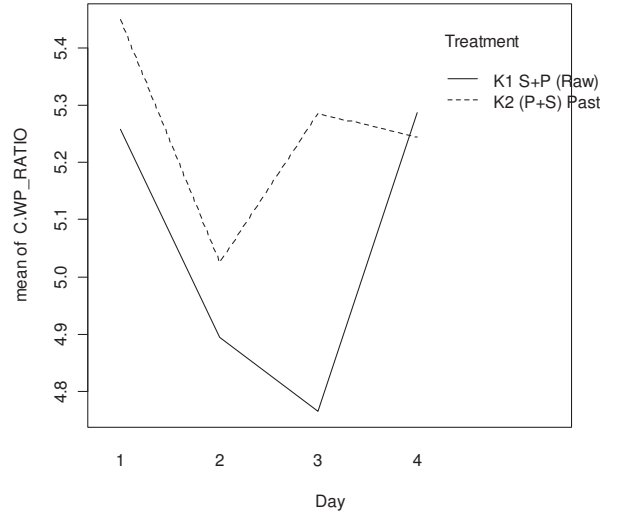

Minerals

MIN_Ca

Interaction plot for MIN_Ca

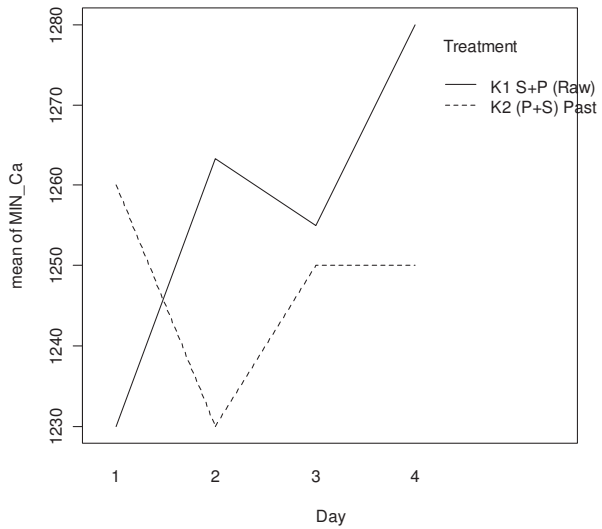

MIN_K

Interaction plot for MIN_K

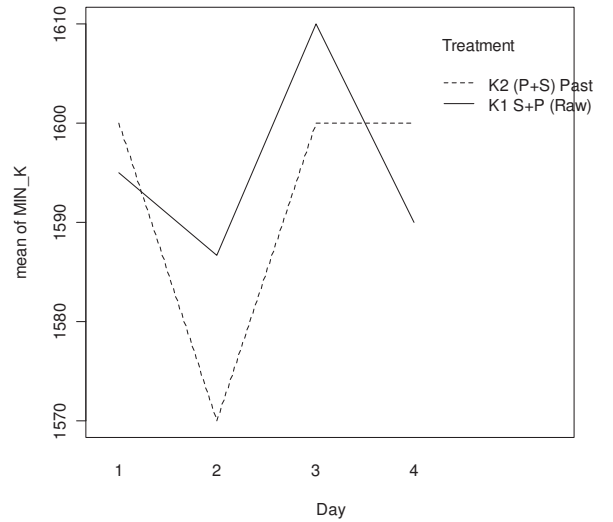
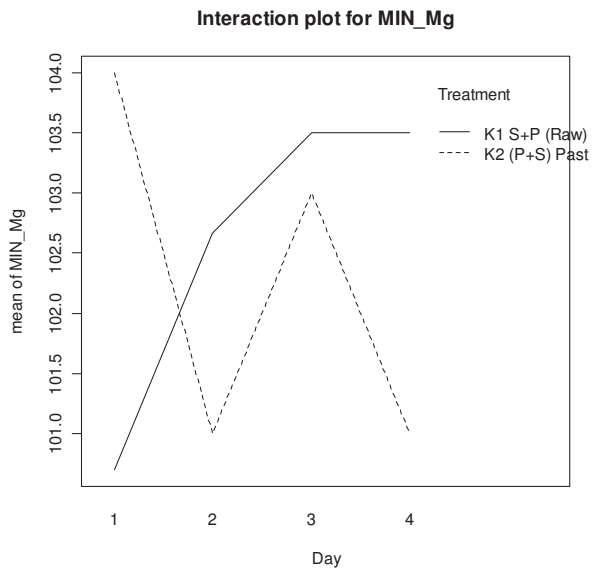
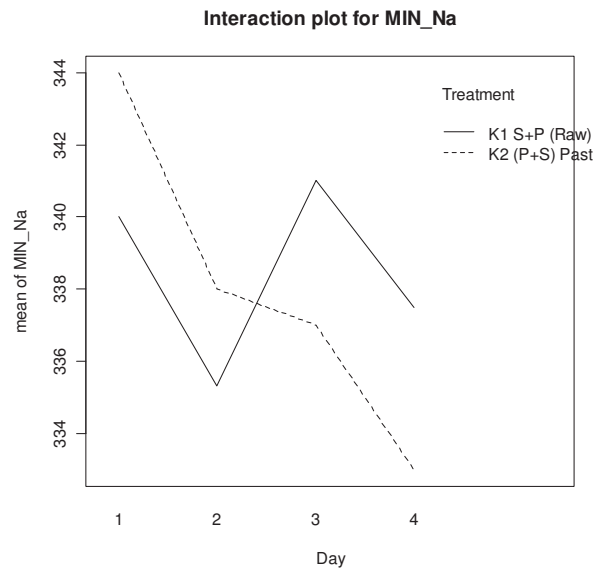

Figure 5-9 continued. Figure continued on next page.

MIN_Mg



MIN_Na



MIN_TP

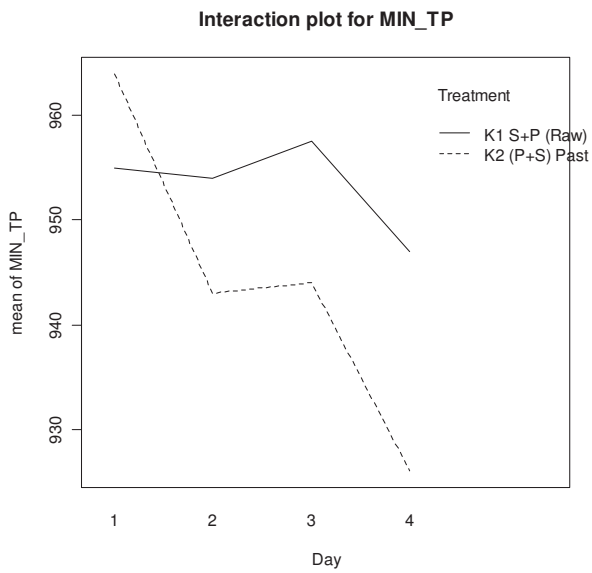

MIN_IP_AS_PO4

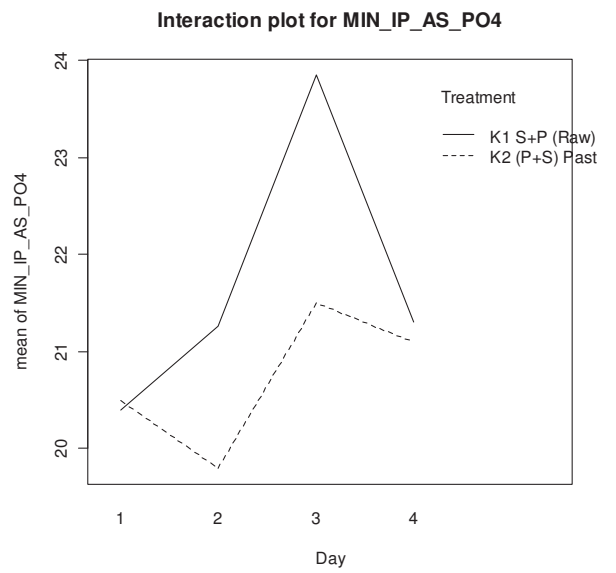
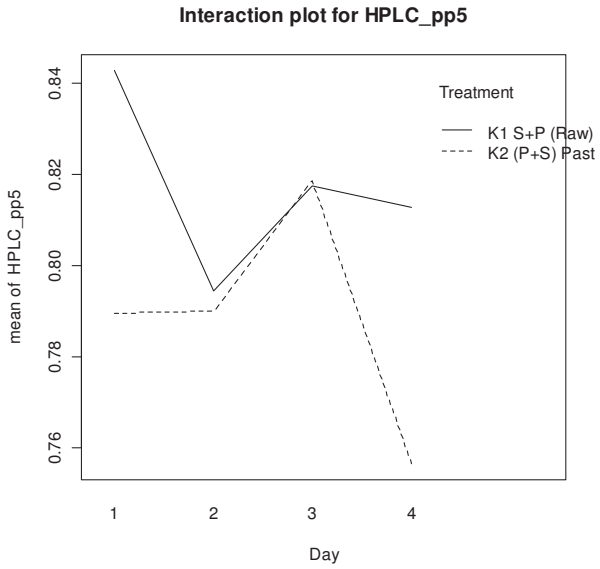

Figure 5-9 continued. Figure continued on next page.

MINOR PROTEINS

HPLC_pp5



HPLC_ALA

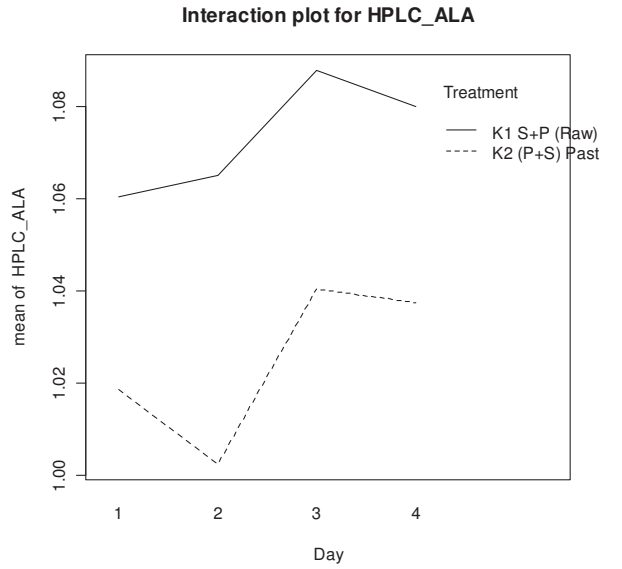

HPLC_Lf

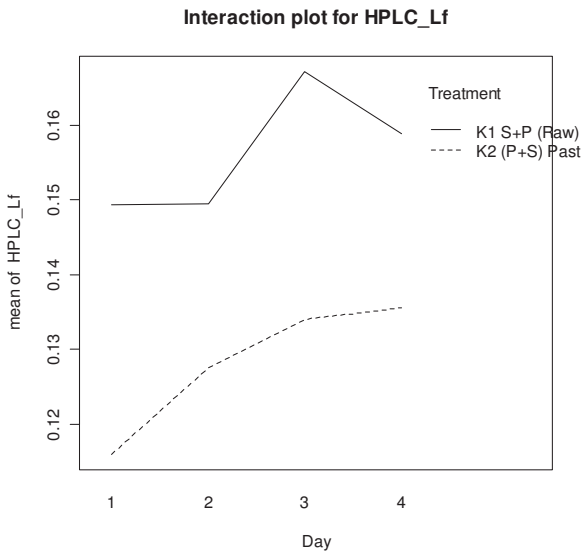

HPLC_BSA

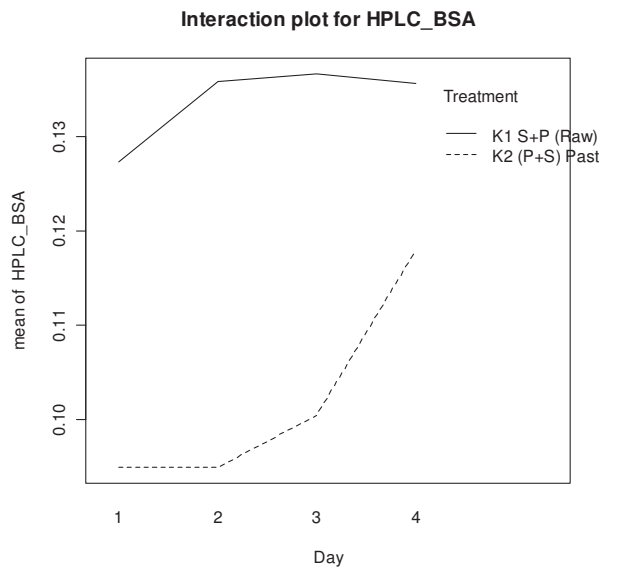

Figure 5-9 continued. Figure continued on next page.

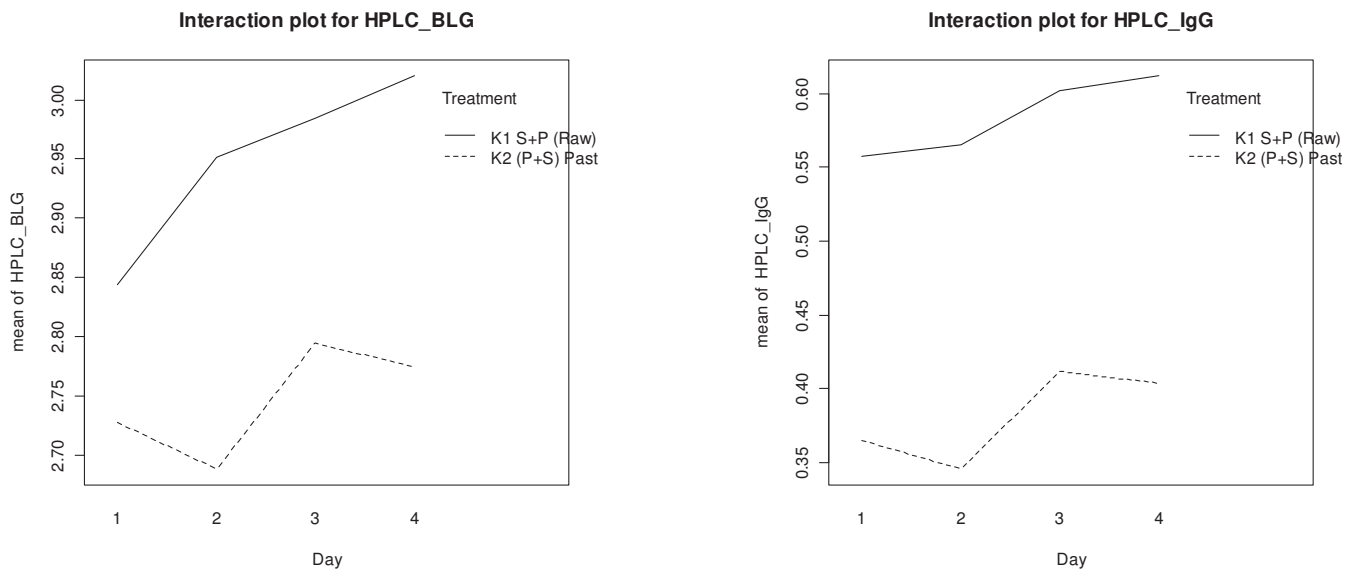

Figure 5-9 continued.

Statistical Analysis

S+P Raw (K1) was compared with P+S Past (K2) (Figure 4-2 and Figure 4-3). This was the only comparison possible. The treatment was therefore pasteurisation (PAST); the effect of order could not be assessed.

As only one separating temperature (TEMP) could be investigated in P+S (K2, 50 °C), but three in S+P (K1; 45, 50 and 55 °C), TEMP could not be treated as a main factor; it was nested in PAST. This allowed the effect of the PAST:TEMP interaction to be evaluated.

The DAY:PAST interaction effect was found to be insignificant for all responses. It was therefore included in the ANOVA residuals.

Discussion

There were significant DAY (milk batch) effects for a number of milk components (*Chem analyses* in Table 5-10) and whey proteins (*Minor proteins* in Table 5-11).

Pasteurisation had significant effects only on the whey proteins, and correspondingly, on NCN (Table 5-11 and Figure 5-9). The % change column in Table 5-11 shows that

pasteurisation caused consistent significant absolute decreases in native whey proteins, as it did in the case of whole milk in the Pilot Plant trials (section 5.1.1)

The effects of pasteurisation on skim milk in the Kauri trials were similar to those found for skim milk in the Pilot Plant trials.

The pasteurisation-separating temperature (PAST:TEMP) interaction was significant for some responses, indicating an effect of separating temperature, but the effect was inconsistent. This suggests that the effect was slight overall.

The concomitance, as for the whole milks, of the DAY effects for MIN_IP_AS_PO4 and CASEIN is noted.

Microbiological Analysis

The K2 pasteurised skim milks all had lower coliform counts than the K1 raw skim milks.

The APC counts of the K2 pasteurised skim milks were higher than those of the K1 raw skim milks in the third and fourth Kauri trials. The APCs of the K1 raw skim milks and the K2 pasteurised skim milks was roughly the same for the first two Kauri trials.

The thermophile counts of the K1 raw skims and the K2 pasteurised skims were approximately the same.

The microbiological results for the Fonterra Kauri trials are not particularly reliable, as there was quite some delay between the samples being taken and when they were analysed.

5.3.3 Fonterra Kauri Creams

The raw data tables for the Kauri cream analyses are displayed in Appendix 14. The ANOVA tables for the Kauri creams are shown in Appendix 15.

A summary of the ANOVA results for Kauri Creams is shown in Table 5-12.

Particle Size distribution analyses were not performed on all of the Kauri creams in order to minimise the cost of the trials.

Table 5-12 Summary of ANOVA model p-values for Fonterra Kauri cream data

Response	DAY	ORDER	PAST	DAY:ORDER	DAY:PAST
Chem analyses					
MSCAN_PROT	3.220e-05 ***	2.851e-07 ***	0.0002467 ***	----	----
MSCAN_FAT	0.0005582 ***	1.701e-05 ***	0.0032116 **	----	----
MSCAN_TS	0.0004292 ***	2.43e-05 ***	0.0030668 **	----	----
PSD variables					
PSD_Conc	0.0132959 *	0.0120119 *	----	0.0007175 ***	0.0474046 *
PSD_VWMD	7.817e-05 ***	2.683e-05 ***	0.0045291 **	8.756e-07 ***	0.0004809 **
PSD_SSA	0.0006424 ***	0.0371645 *	0.0579222 .	0.0001884 ***	0.0494247 *
PSD_Span	0.035829 *	0.049950 *	----	0.001045 **	0.062559 .
PSD_Unif	0.087699 .	0.085436 .	----	0.003124 **	0.093394 .
PSD_SWMD	0.000195 ***	0.001192 **	0.016099 *	1.377e-05 ***	0.009796 **
PSD_D(0.1)	0.00200 **	----	0.03324 *	0.07107 .	----
PSD_D(0.5)	3.763e-06 ***	1.183e-06 ***	0.0002797 ***	4.122e-08 ***	3.257e-05 ***
PSD_D(0.9)	4.983e-05 ***	1.389e-05 ***	0.0031030 **	4.758e-07 ***	0.0002811 ***

A table of the percentage changes in the compositional variables for the Kauri creams is displayed in Table 5-13.

Table 5-13 Percentage changes in the milk compositional variables for the Fonterra Kauri cream data

Response	ORDER (S+P → P+S)	PAST (Raw → Past)
Chem analyses		
MSCAN_PROT	4.5	1.7
MSCAN_FAT	-4.8	-1.8
MSCAN_TS	-3.7	-1.4
PSD variables		
PSD_Conc	23	5.4
PSD_VWMD	49	17
PSD_SSA	-5.4	-3.5
PSD_Span	18	3.7
PSD_Unif	19	3
PSD_SWMD	11	5.4
PSD_D(0.1)	0.66	2.5
PSD_D(0.5)	42	15
PSD_D(0.9)	74	25

Note :

Table entries are **highlighted** as being significant **absolute** changes when

The factor (TREATMENT) is statistically significant (p-value < 0.05)

AND

The interaction with DAY is not significant

OR

The interaction with DAY is significant but is not **cross-over**

A **cross-over** interaction is one in which the two lines intersect. **Significant** entries with **cross-over** are **highlighted**. (Significance is due only to difference between Day 1 and other Days).

The interaction plots for the Kauri Creams are displayed in Figure 5-10.

CHEM VARIABLES

MSCAN_PROT

Interaction plot for MSCAN_PROT

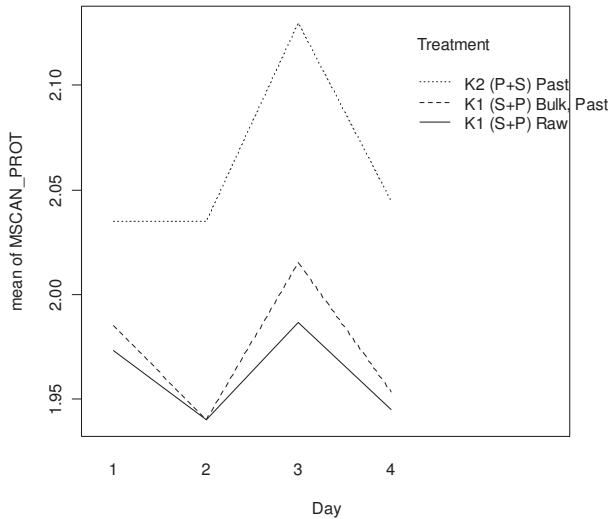

MSCAN_FAT

Interaction plot for MSCAN_FAT

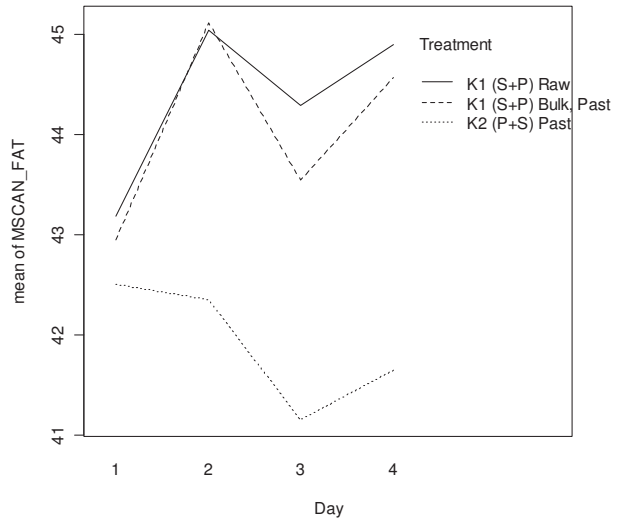

MSCAN_TS

Interaction plot for MSCAN_TS

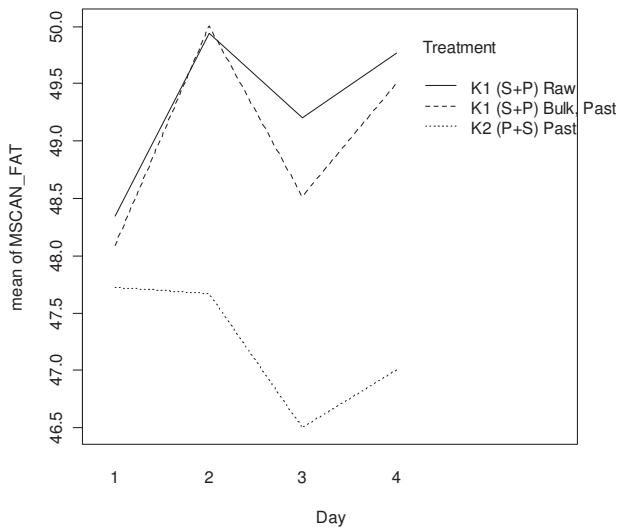
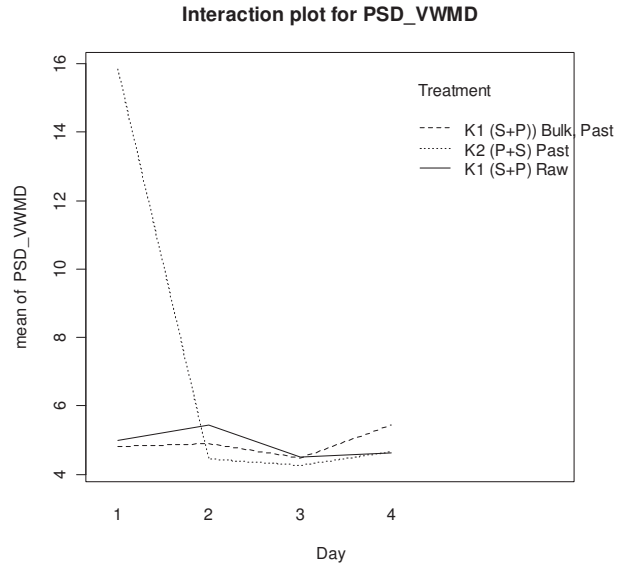
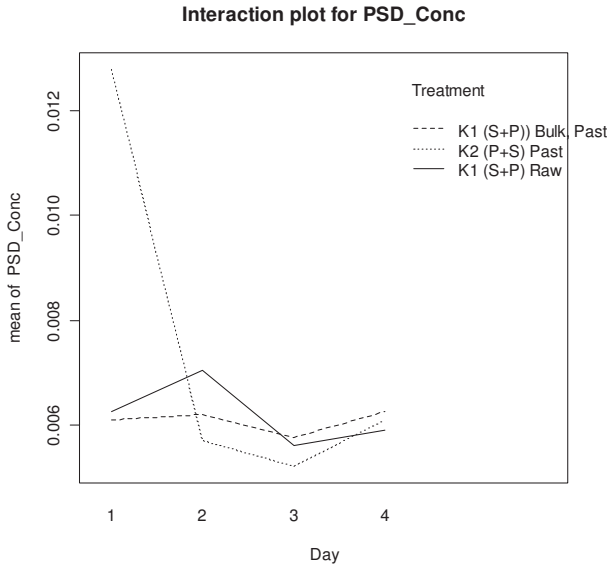

Figure 5-10 Interaction Plots for Fonterra Kauri cream. Figure continued on next page.

PSD variables

PSD_Conc

PSD_VWMD



PSD_SSA

PSD_Span

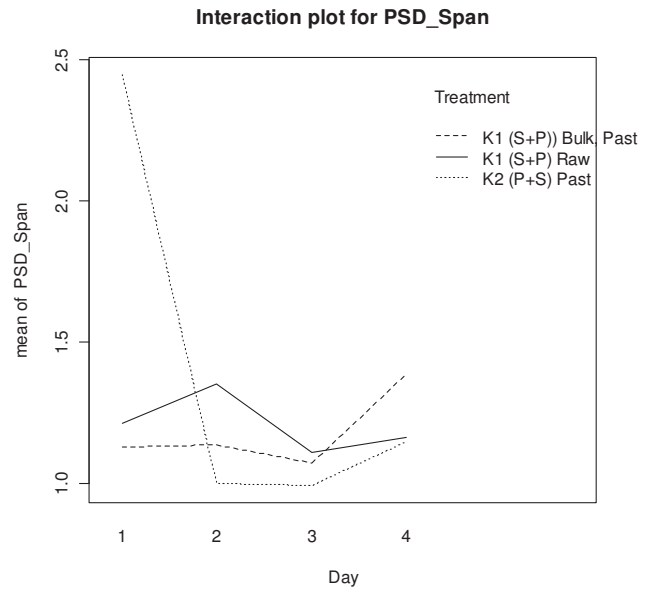
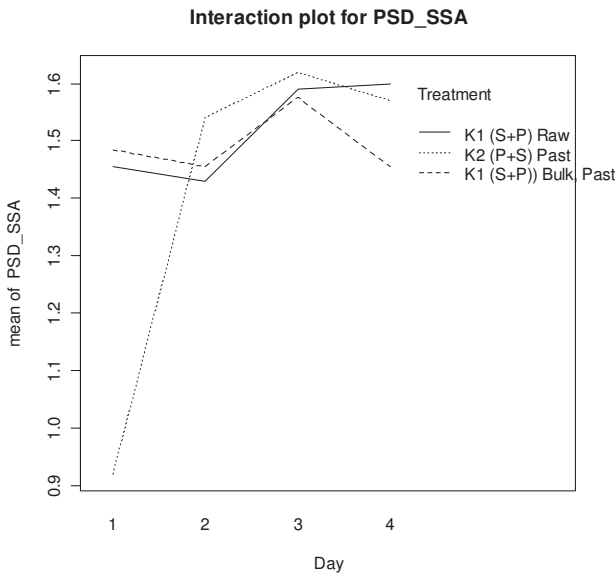
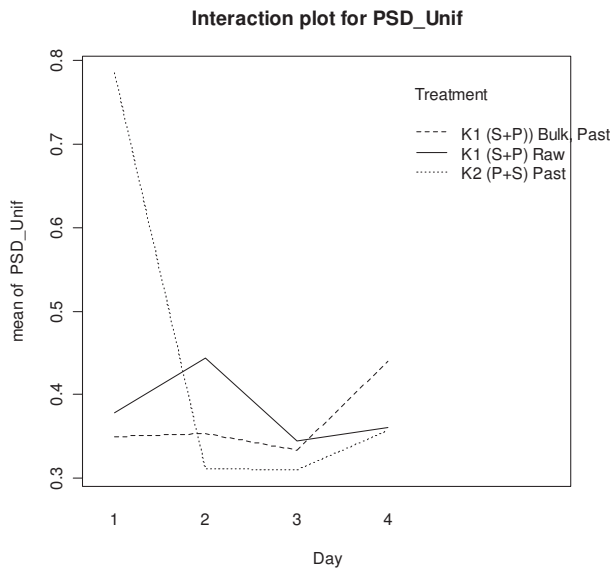
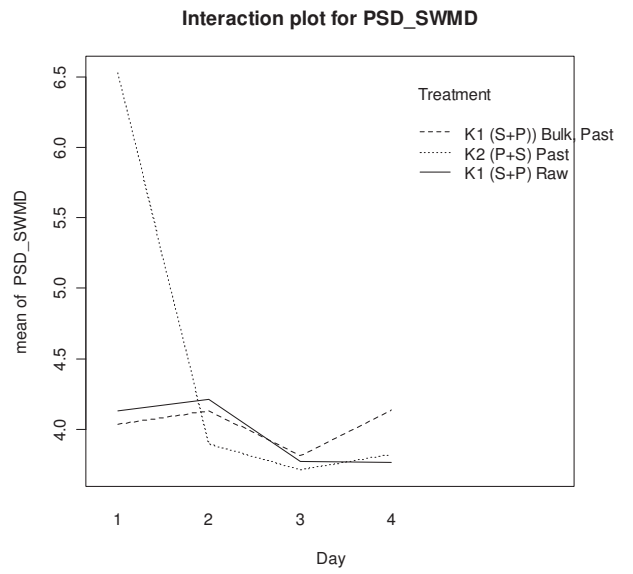

Figure 5-10 continued. Figure continued on next page.

PSD_Unif



PSD_SWMD



PSD_D(0.1)

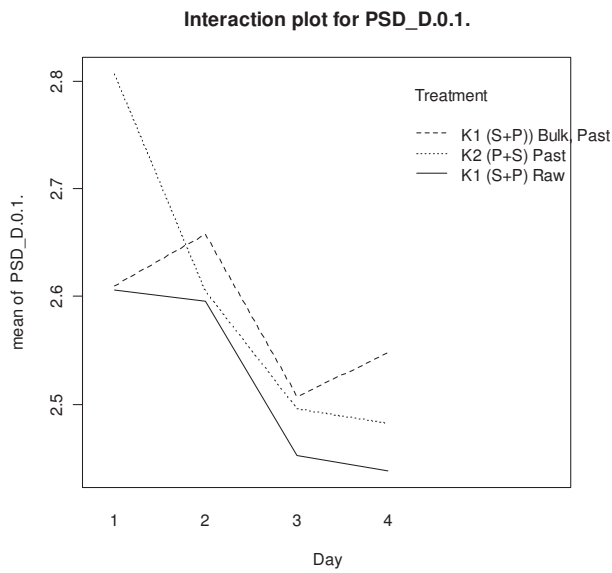

PSD_D(0.5)

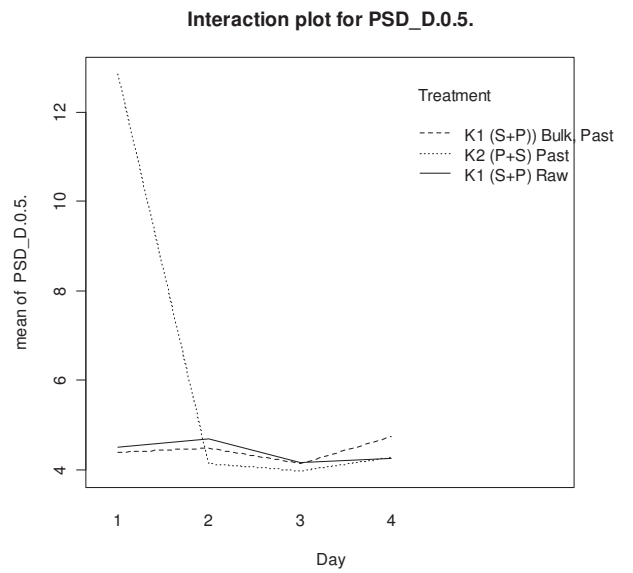

Figure 5-10 continued. Figure continued on next page.

PSD_D(0.9)

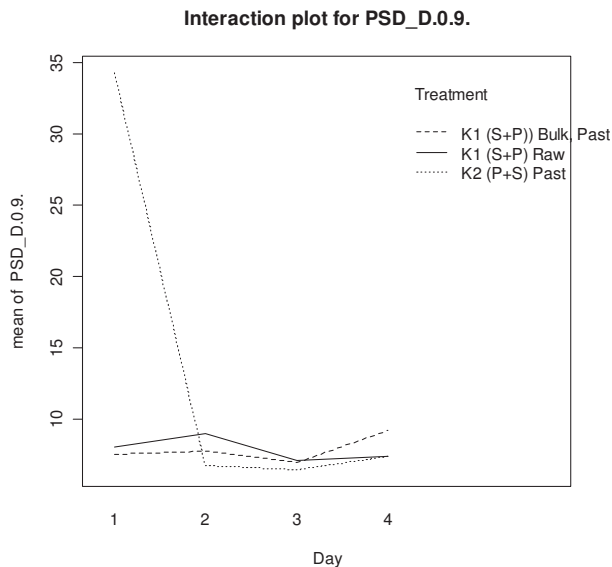

Figure 5-10 continued.

Statistical Analysis

The effect of ORDER was assessed by comparing S+P (K1, Bulk Pasteurised) with P+S (K2, Pasteurised) (see Figure 4-2 and Figure 4-3). Separating temperature was nested within ORDER because there was only one separating temperature (50 °C) for the K2 configuration, but three (45, 50 and 55 °C) for the K1 configuration. The effect of separating temperature as such could not be evaluated.

The effect of PAST was assessed by comparing S+P (K1, Raw) with the mean of S+P (K1, Bulk Pasteurised) and P+S (K2, Pasteurised). PAST and ORDER were independent factors.

It is pointed out that, as shown in Figure 4-2, the cream flow from Separator 1 (the test separator) in the K1 configuration was blended with the cream flows from Separators 2 and 3 prior to pasteurisation and subsequent sampling and analysis. Therefore, results must be viewed in the light of the dilution of Separator 1 cream by the cream from the other two separators. The other separators in the K1 configuration were operating at separating temperatures of approximately 58 °C.

Discussion

Overall, DAY (milk batch) had highly significant effects. However, the DAY effect on PSD may have been artificially magnified by the possibly anomalous PSD data for DAY 1 (Figure 5-10).

ORDER and PASTEURISATION had significant effects on most responses (Table 5-12). However, there were significant absolute percentage effects only for the *Chem analyses* responses (Table 5-12). The relatively large effect of ORDER on these responses should perhaps be viewed with caution given the lack of replication in the *Particle Size Distribution* responses.

The significance of the absolute effects on PSD (Table 5-13) caused by ORDER and PAST is due solely to the differences in this response between DAY 1 and the other three days (Figure 5-10). No such differences were found for the *Chem analyses* responses.

The significance of the DAY:ORDER and DAY:PAST interactions for PSD (Table 5-12) is also almost certainly due only to the difference in the PSD responses between Day 1 and Days 2 – 4.

Cream microbiological analysis

The cream samples for microbiological testing were taken only from the runs at the separating temperatures of 45°C and 50°C. This was done in order to reduce the costs associated with the analytical testing. The microbiological results are unreliable due to the delay between sampling and when the analyses were performed.

The K1 raw creams had APC, coliform, thermophilic and thermophile counts that were in the same range as those of the K1 bulk pasteurised creams.

The K2 pasteurised creams all had much lower coliform counts than those of the K1 bulk pasteurised creams.

5.3.4 Kauri Separator Sludges

The raw data for the Kauri separator sludges is displayed in Appendix 16. The ANOVA tables for the Kauri sludge responses are shown in Appendix 17.

A summary of the ANOVA results for the Kauri separator sludges is shown in Table 5-14.

Table 5-14 Summary of ANOVA model p-values for Fonterra Kauri sludge data

Signif. codes: 0 ‘***’ 0.001 ‘**’ 0.01 ‘*’ 0.05 ‘.’ 0.1 ‘ ’ 1

Response	DAY	PAST	% Change (Raw → Past)
Chem Analyses			
NCN	----	0.05929 .	-37
NPN	----	----	-20
TN_LIQ	----	----	-15
FAT_RG	----	----	1.2
TS	----	----	-15
CRUDE_PROT	----	----	-15
TRUE_PROT	----	----	-15
CASEIN	----	----	-0.22
WHEY_PROT	----	0.03876 *	-42
C.WP_RATIO	----	0.01845 *	86
Minerals			
MIN_Ca	----	----	-11
MIN_K	----	----	-16
MIN_Mg	----	----	-12
MIN_Na	----	----	-14
MIN_P	----	----	-13
MIN_IP_AS_PO4	----	----	-22
Minor Proteins			
HPLC_pp5	----	----	-10
HPLC_ALA	----	----	6.3
HPLC_LF	----	0.0003518 ***	-59
HPLC_BSA	----	0.0596 .	-13
HPLC_BLG	----	0.07487 .	-10
HPLC_IgG	----	0.001106 **	-51

Note : TREATMENT effect is PAST since treatments are S+P (raw) and P+S (past)

Table entries are **highlighted** as being significant **absolute** changes when

The factor (TREATMENT) is statistically significant (p-value < 0.05)

AND

The interaction with DAY is not significant

OR

The interaction with DAY is significant but is not **cross-over**

The interaction plots for the Kauri sludges are displayed in Figure 5-11.

CHEM VARIABLES

NCN

NPN

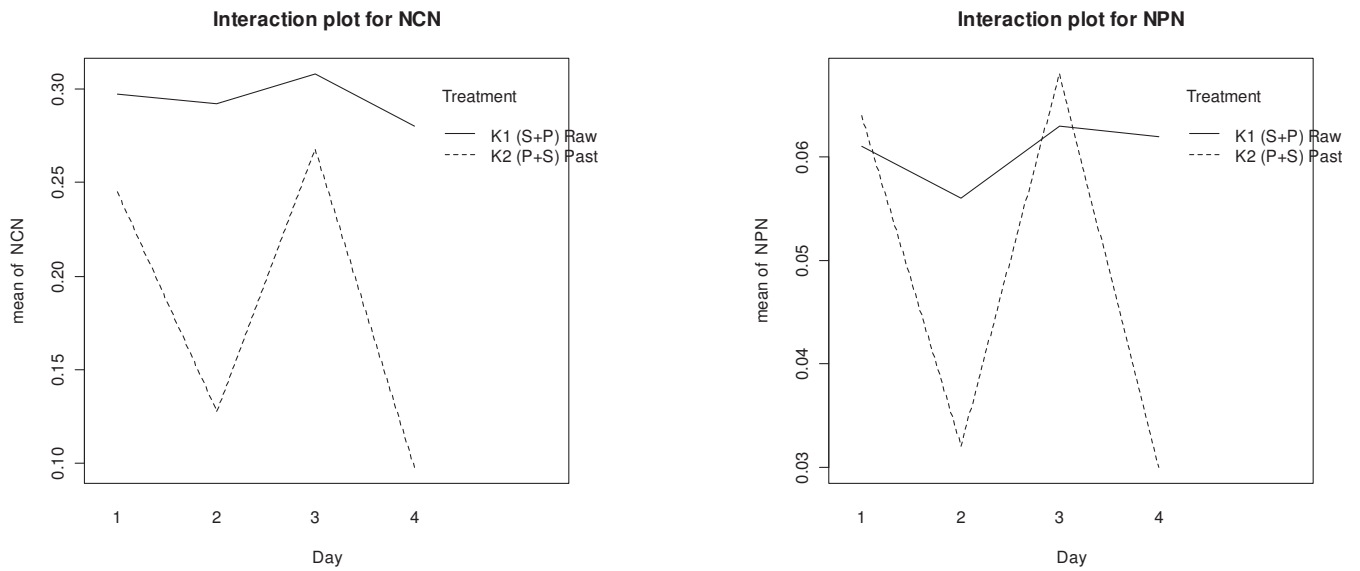
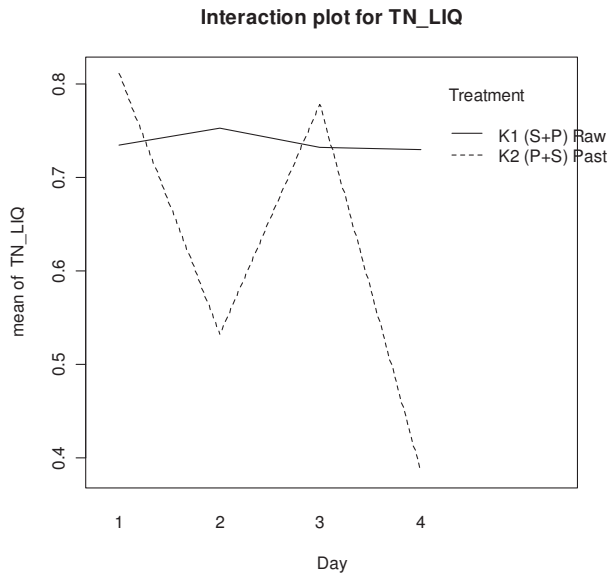
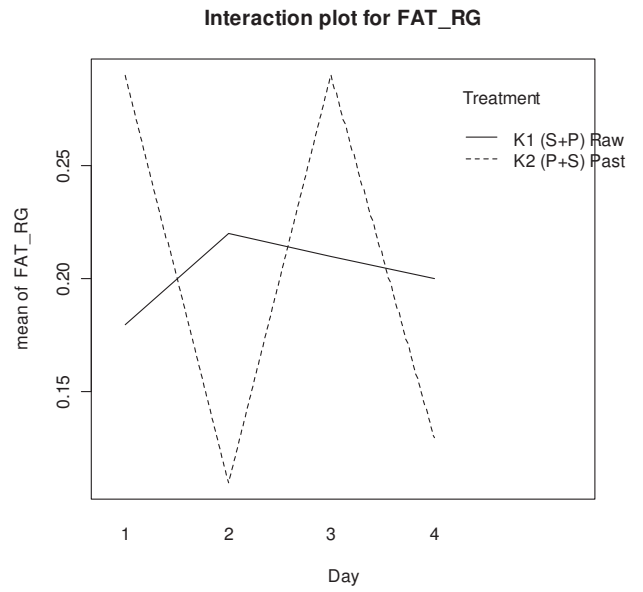

Figure 5-11 Interaction Plots for Fonterra Kauri Sludge. Figure continued on next page.

TN_LIQ



FAT_RG



TS

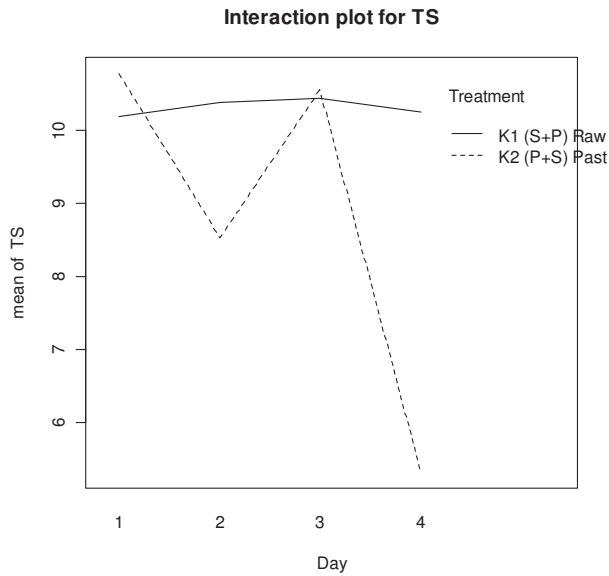

CRUDE_PROT

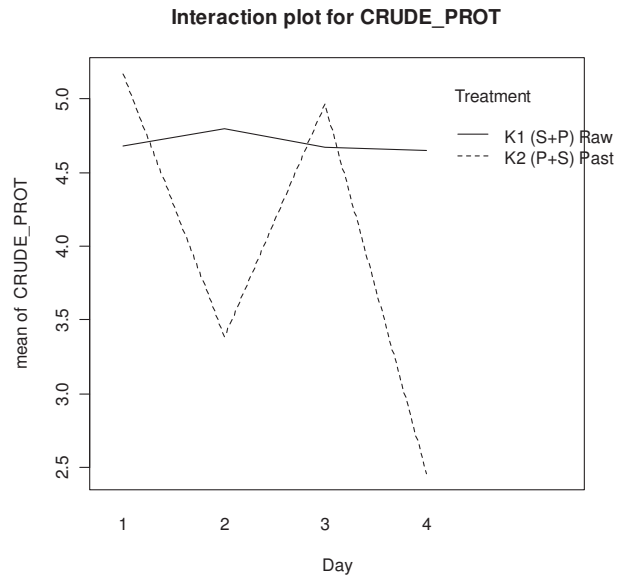
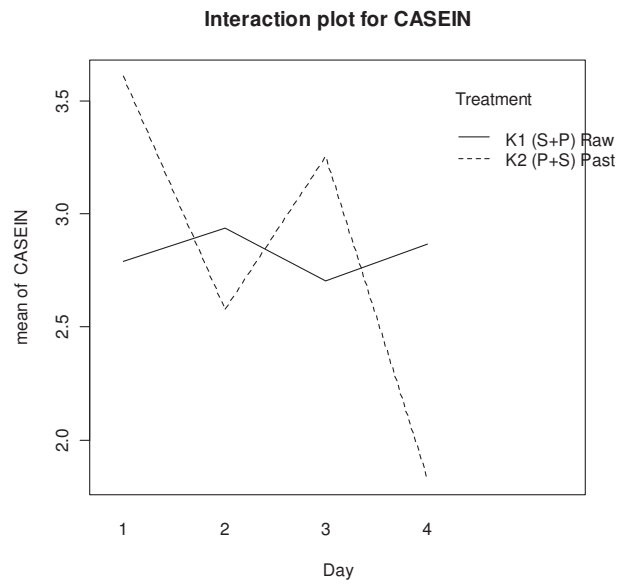

Figure 5-11 continued. Figure continued on next page.

TRUE_PROT



CASEIN



WHEY_PROT

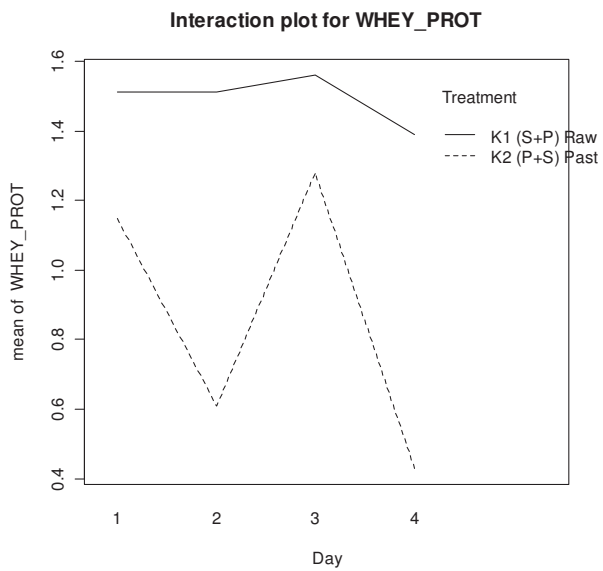

C.WP_RATIO

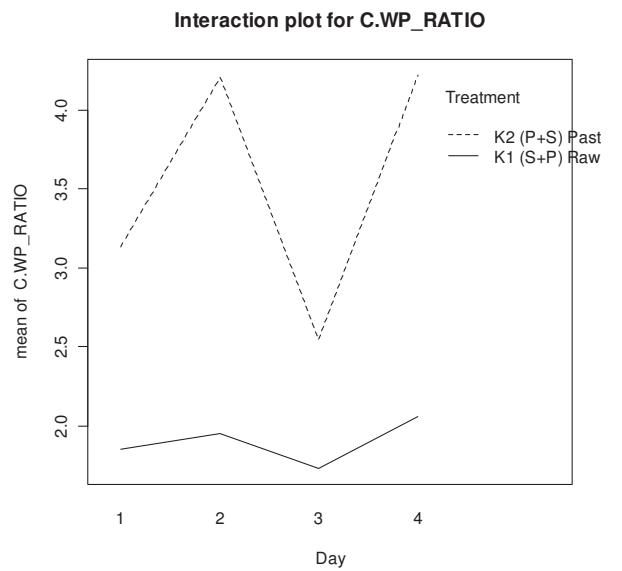

Figure 5-11 continued. Figure continued on next page.

Minerals

MIN_Ca

MIN_K

Interaction plot for MIN_Ca

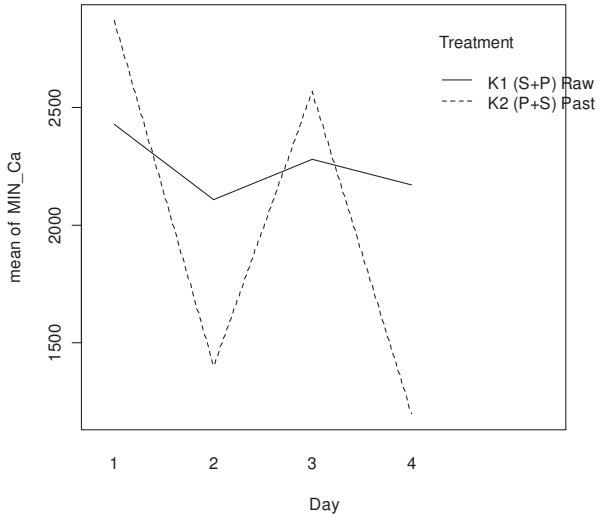

Interaction plot for MIN_K

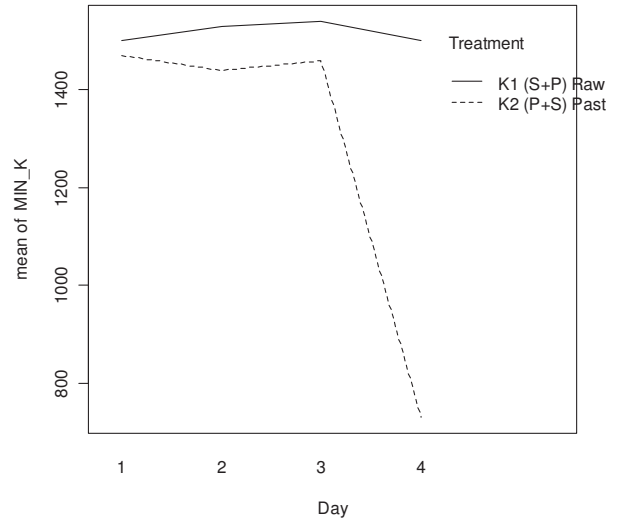

MIN_Mg

MIN_Na

Interaction plot for MIN_Mg

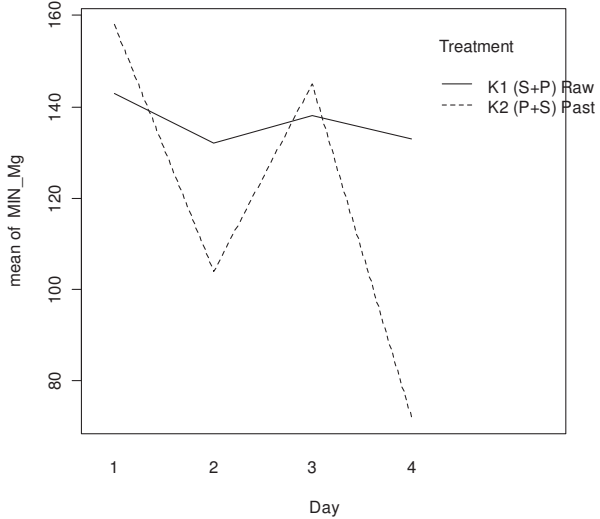

Interaction plot for MIN_Na

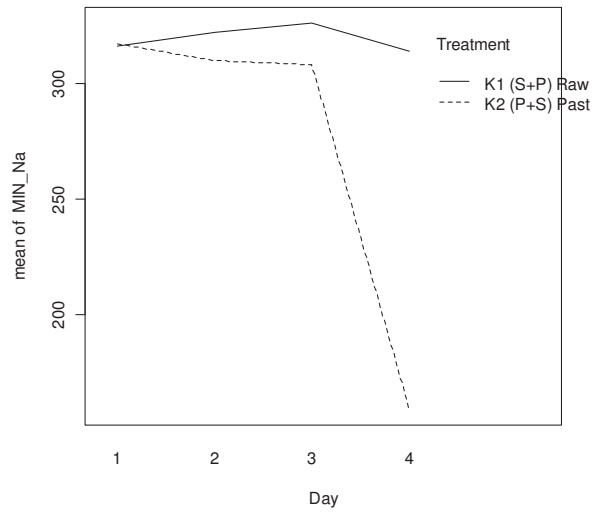
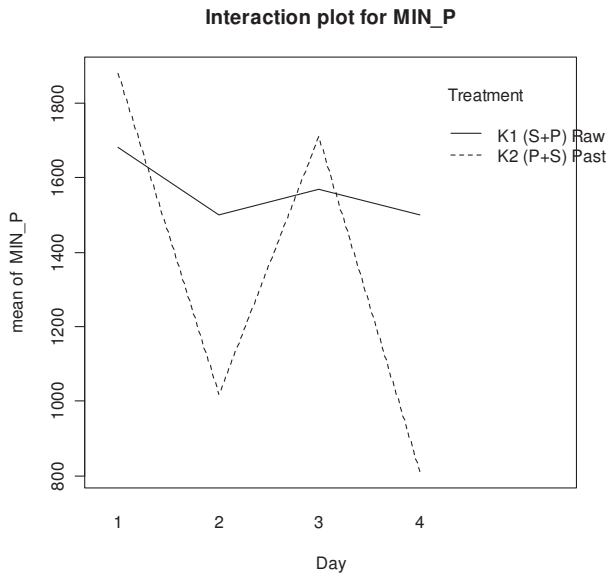
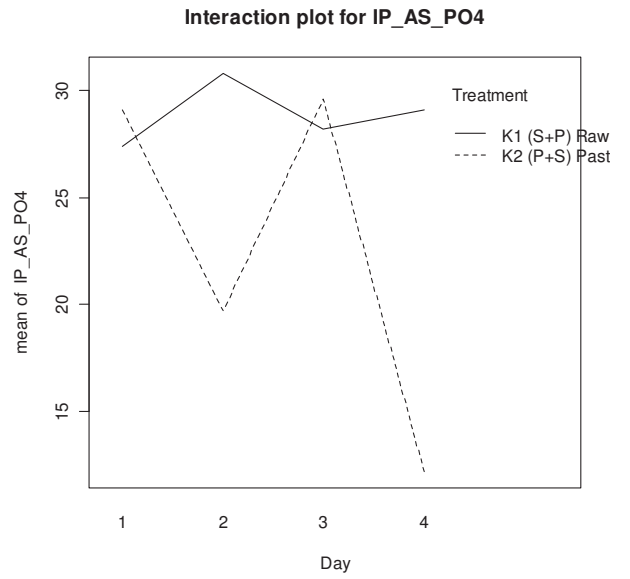

Figure 5-11 continued. Figure continued on next page.

MIN_P



IP_AS_PO4



MINOR PROTEINS

HPLC_pp5

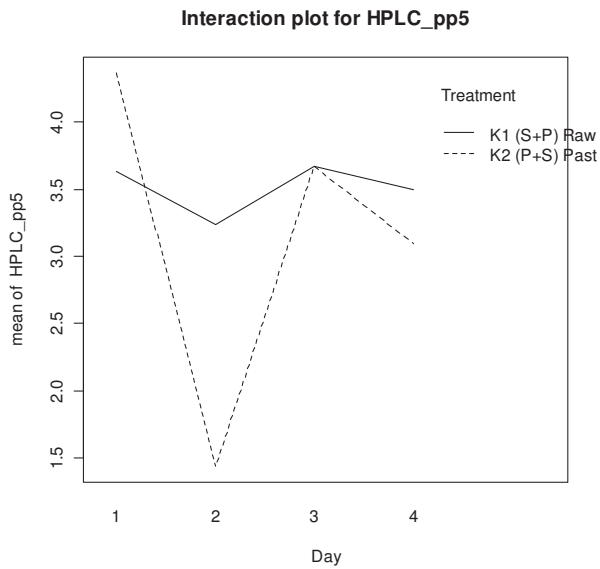

HPLC_ALA

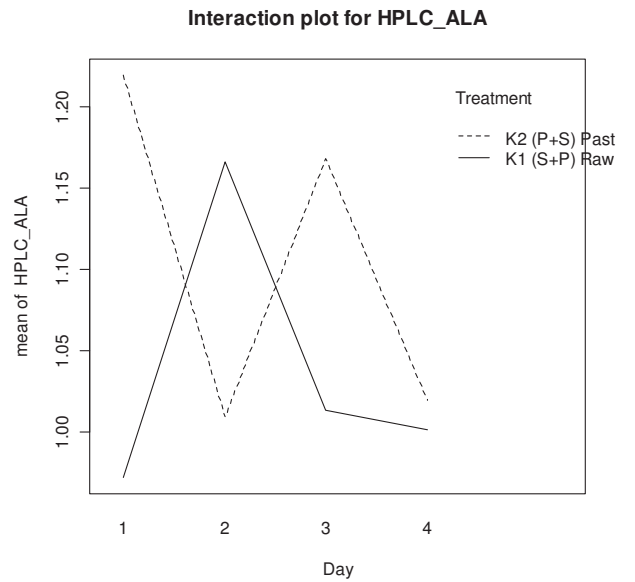
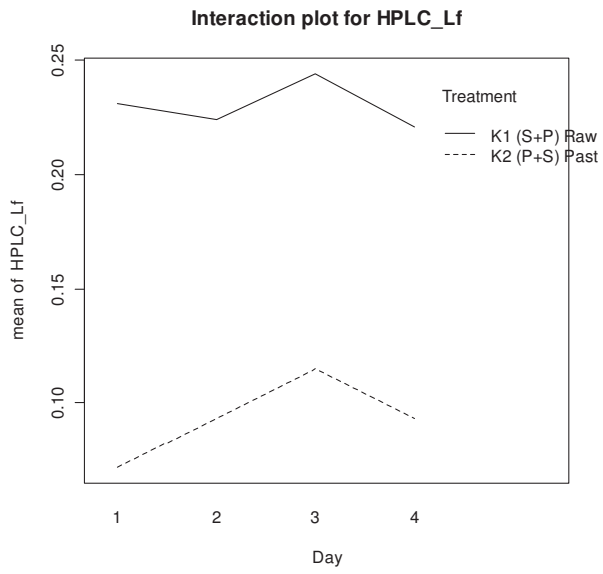
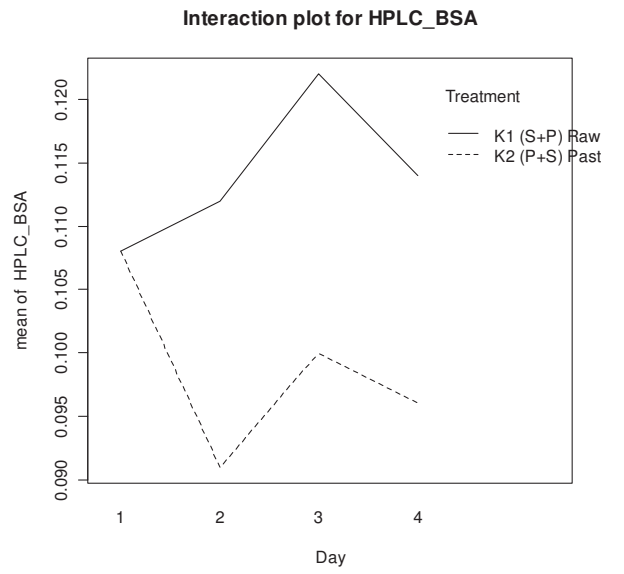

Figure 5-11 continued. Figure continued on next page.

HPLC_Lf



HPLC_BSA



HPLC_BLG

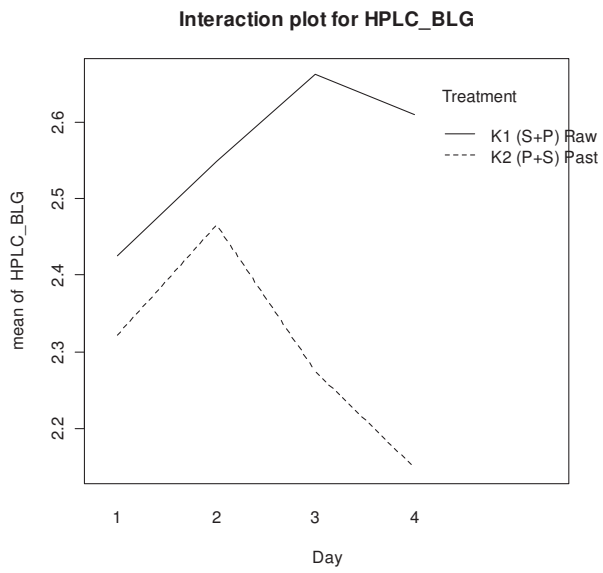

HPLC_IgG

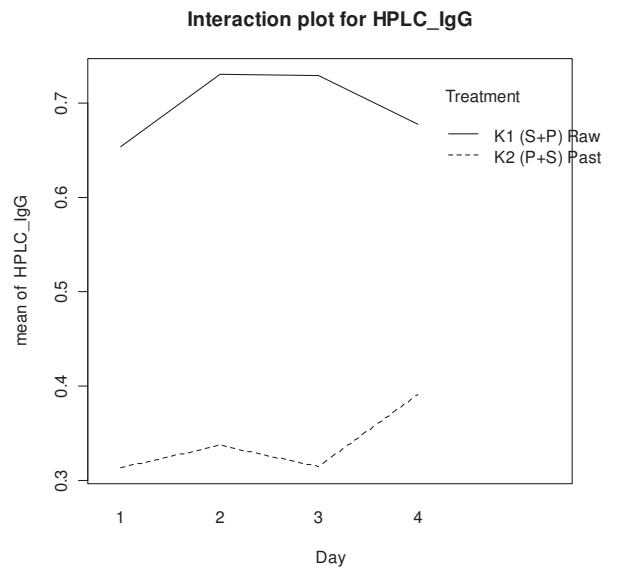

Figure 5-11 continued.

Statistical Analysis

As for separator sludge in the Pilot Plant trials, the only treatment was pasteurisation (PAST). ORDER was involved only nominally because the S+P (K1) sludge was raw and the P+S (K2) sludge was pasteurised.

Separating temperature could not be treated as a main factor. It was nested within ORDER, as for cream and for the same reason. Thus the effect of separating temperature could not be evaluated.

Discussion

Figure 5-11 shows that while the composition of K1 sludge varied only slightly from Day to Day, that of K2 sludge fluctuated widely. The pattern of variation was roughly the same for twenty out of the twenty-two responses. This suggests that there was a problem or error in the collection of sludge samples from the K2 separator on some or all of the four Days. For example, the wide fluctuations in most of the response variables for K2 could have been due to dilution with water of sludge samples taken on Day 2 and/or Day 4. In spite of this, there were no significant Day (milk batch) effects; only one sample of sludge was taken from each configuration (for each separating temperature) on each DAY.

There were four significant absolute changes (Table 5-14) caused by pasteurisation: large decreases in HPLF_LF, HPLC_IgG and WHEY_PROT, and a large increase in C.WP_RATIO. The directions of these changes (and of the change, albeit insignificant, in NCN) were consistent among themselves. The sizes of the changes may have been magnified by the large day-to-day fluctuations in the K2 responses (although these fluctuations were rather narrower for HPLC_LF and HPLC_IgG than they were for WHEY_PROT and C.WP_RATIO).

The overall effect of PAST was largely insignificant.

5.4 Kauri Trials – Conclusions and comparison with Pilot Plant Trials

The Kauri trials provided limited information on the effects of the order of pasteurisation and separation, and of separating temperature. This was due to the configurations of the Kauri plants K1 and K2, and the fact that only one separating temperature could be set on the K2 plant.

Significant DAY (milk batch) effects were found for many response variables for whole milk, skim milk and cream, especially the whey proteins in the case of whole milk and skim milk.

The separating temperature effect (as shown by the PAST:TEMP interaction effects for skim milk; Table 5-11) should be viewed in the light of batch-to-batch variability in the composition of the feed raw milk.

There is no evidence in the Kauri results for large effects of order of pasteurisation or of separating temperature. To this extent, the Kauri trials confirm, rather than otherwise, the findings of the Pilot Plant trials.

It is noted again here that chemical and other analyses of the A and B samples of the process streams (samples taken at different times during an experimental run) yielded well replicated values of response variables. This allows confidence to be placed in the results that have been presented here.

5.5 Mineral Survey Results

The raw data for the whole milks and sludges are presented in Appendix 18 and Appendix 19, respectively. The ANOVA results tables of the mineral survey results are displayed in Appendix 20.

After accounting for the total solid content of the sludge by normalization of the data by sludge total solids content, significant batch differences were found in the mineral content of the separated sludge for all the minerals examined (Table 5-15). For calcium, potassium and phosphate, content variability was found to be due to site

variation only. Variability in the levels of sodium, magnesium and total phosphorus could not be attributed to changes in either site or time. However, for all minerals the combination of site and time was important in explaining batch differences.

Significant differences due to different separators at the Clandeboye and Kauri plants were found only for magnesium and phosphate. The separator effects at the Whareroa and Edendale plants were indistinguishable from site differences, since only one separator was used at each of these two plants.

Table 5-15 Summary of ANOVA model p-values for analyses of sludge minerals

Signif. codes: 0 '***' 0.001 '**' 0.01 '*' 0.05 '.' 0.1 ' ' 1

Response	BySite	ByWeek	Batch	Separator
Minerals				
Split plot				
Ca.TS	0.04786 *	0.12281	-----	-----
K.TS	0.001991 **	0.141058	-----	-----
Mg.TS	0.18735	0.07592 .	-----	-----
Na.TS	0.2113	0.509	-----	-----
TP.TS	0.05406 .	0.17176	-----	-----
PO4.TS	0.02707 *	0.27504	-----	-----
Fixed effects				
Ca.TS	-----	-----	2.634e-08 ***	0.05107 .
K.TS	-----	-----	1.134e-11 ***	0.6764
Mg.TS	-----	-----	8.195e-05 ***	0.01573 *
Na.TS	-----	-----	3.196e-05 ***	0.9383
TP.TS	-----	-----	1.267e-08 ***	0.05547 .
PO4.TS	-----	-----	1.722e-11 ***	0.01275 *

Analysis using the mineral content covariates examined the relationship between the mineral content of the whole milk and that of the separated sludge. After correcting for different batches of incoming milk and a possible separator effect, it was found that variation in the mineral content of the whole milk did not affect the mineral composition in the sludge.

Correlation analysis

Correlations between mineral content response variables are shown in Table 5-16.

The correlation coefficient for a pair of continuous variables is a measure of the strength of the linear relationship between them. Correlations take values between -1 and +1, a positive value indicating that an increase in the first variable produces a corresponding increase in the second variable. A negative correlation is interpreted as a decrease in the value of one variable when the other variable increases.

Table 5-16 Correlation coefficients for correlations between mineral content response variables

	Ca.TS	K.TS	Mg.TS	Na.TS	TP.TS	PO4.TS
Ca.TS	1.00	-0.87	0.89	-0.63	1.00	0.83
K.TS	-0.87	1.00	-0.58	0.69	-0.87	-0.85
Mg.TS	0.89	-0.58	1.00	-0.45	0.88	0.72
Na.TS	-0.63	0.69	-0.45	1.00	-0.66	-0.57
TP.TS	1.00	-0.87	0.88	-0.66	1.00	0.83
PO4.TS	0.83	-0.85	0.72	-0.57	0.83	1.00

The measurements of mineral content were found to be moderately to highly correlated (Table 5-16). The data in Table 5-16 indicates that total phosphorus (TP.TS) is perfectly correlated with calcium content (Ca.TS). This is a reflection of the fact that much of the calcium and phosphorus in milk is located as calcium phosphate in the casein micelles.

Principal component analysis

A principal components analysis was carried out to investigate the underlying structure of the data to determine which features of the data were causing the batch differences. A principal component is a linear combination of the mineral content variables and was constructed to give the greatest possible distinction between data points.

The principal components, as displayed in Table 5-17, were constructed to be orthogonal (independent) with the first component (PC1) explaining the greatest proportion of the variation. The loadings of each variable represent the level of contribution of that variable to the principal component (Table 5-18).

Table 5-17 Proportion of variability explained by each principal component

Importance of components:						
	Comp. 1	Comp. 2	Comp. 3	Comp. 4	Comp. 5	Comp. 6
Standard Deviation	0.7702	0.1665	0.0797	0.0325	0.0144	2.610E-03
Proportion of Variance	0.9438	0.0441	0.0101	0.0017	0.0003	1.084E-05
Cumulative Proportion	0.9438	0.9879	0.9980	0.9997	0.9999	1.000E+00

Table 5-18 Loadings for principal components

	Comp. 1	Comp. 2	Comp. 3	Comp. 4	Comp. 5	Comp. 6
Ca.TS	0.771	-0.372	-0.114	0.276	-0.412	
K.TS	-0.200	-0.134	-0.953	-0.145		
Mg.TS					-0.136	0.987
Na.TS			-0.163	0.838	0.516	
TP.TS	0.446	-0.227		-0.446	0.736	
PO4.TS	0.406	0.890	-0.204			

From Table 5-17 it can be seen that PC1 (principal component 1) explains 94.38% of the variability in the batches. Calcium, with the highest loading of 0.771 (Table 5-18), had the most effect on batch variation. The second principal component (PC2) accounts for only 4.41% (= (0.9879 – 0.9438) x 100)) of the variation, with phosphate content, with the loading of 0.89 (Table 5-18), explaining this effect. Magnesium and sodium were found to have no effect on batch variability.

The first principal component, PC1, can be represented by Equation 5-1:

Equation 5-1 Principal Component 1 (PC1)

$$PC1 = 0.771 \text{ Calcium} - 0.200 \text{ Potassium} + 0.446 \text{ Phosphorus} + 0.406 \text{ Phosphate}$$

The second principal component, PC2, can be represented by Equation 5-2:

Equation 5-2 Principal Component 2 (PC2)

$$PC2 = 0.372 \text{ Calcium} - 0.134 \text{ Potassium} - 0.227 \text{ Phosphorus} + 0.890 \text{ Phosphate}$$

Using these equations, principal component “scores” can be calculated for each observation, i.e. each time point in the dataset, and these scores plotted to investigate patterns in the data. A plot of PC1 against PC2 (Figure 5-12), with each point labelled by separator and week, reveals that points are reasonably clustered by site. Within the site clusters the points are also grouped according to the two different weeks.

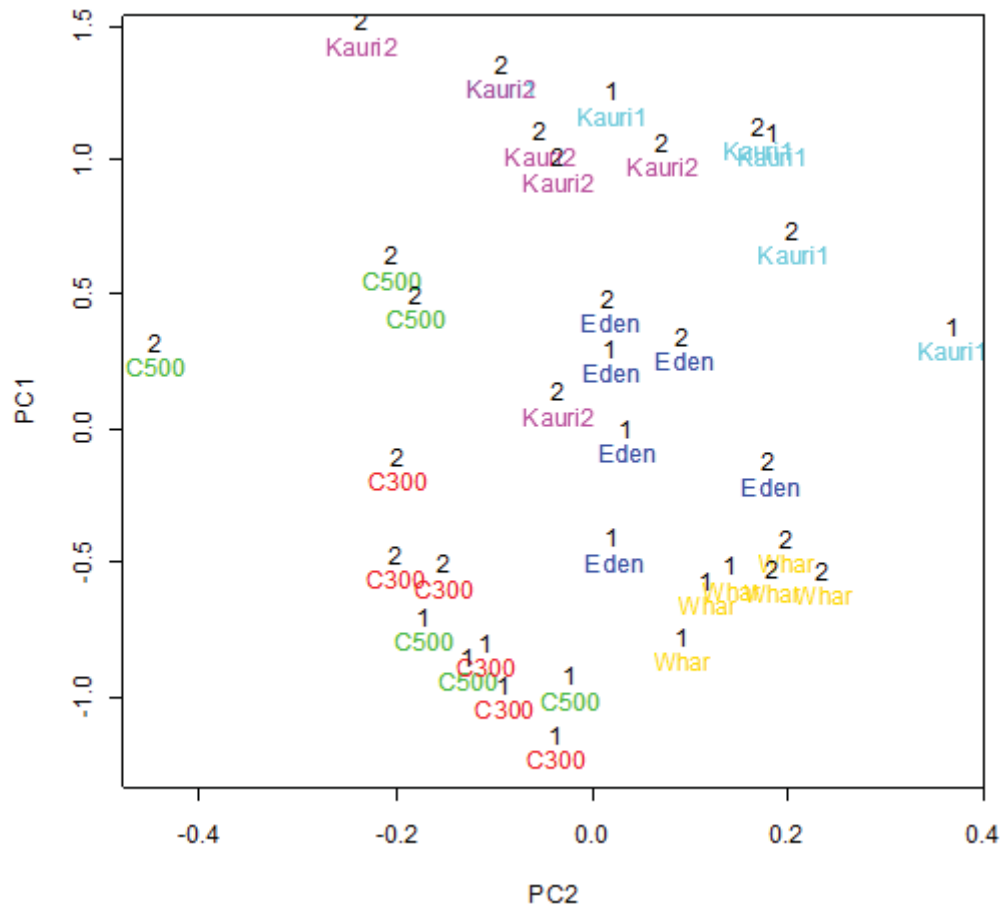

Figure 5-12 Principal components plot for separator sludge minerals composition. Individual separators are identified as C300 and C500 at Clondeboye, Eden at Edendale, Kauri 1 and Kauri 2 at Kauri, and Whar at Whareroa. Weeks 1 and 2 are identified by the numerals 1 and 2.

PC1 differentiates the Kauri site from the other three sites, with Kauri consistently having the highest scores. This differentiation is driven by the calcium content of the sludge. PC2, representing phosphate content, distinguishes between the Clondeboye, Edendale and Whareroa sites. However, this differentiation is minimal compared with the influence of changes in calcium, since PC2 represents only 4.41% of batch variability.

Interaction Plot

An interaction plot (Figure 5-13), comprising only those variables significant in the principal component analysis, was constructed to demonstrate how mineral content levels changed across the six separators.

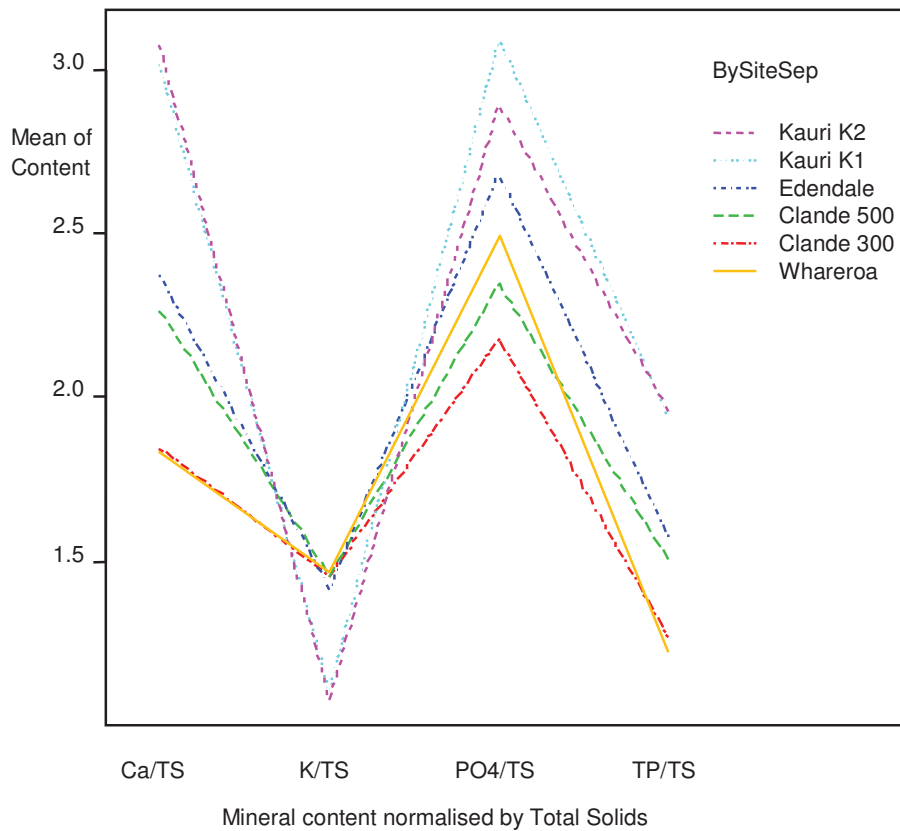

Figure 5-13 Interaction Plot showing differences in sludge mineral content by separator

Figure 5-13 indicates that calcium content caused the greatest differentiation between the sites. Calcium contents were highest at the Kauri site and similar for both separators. The lowest calcium contents were found for the Clandeboye 300 and Whareroa separators. Similar levels of calcium were indicated for the Clandeboye 500 and Edendale and separators, in the mid-range of values. Phosphate content measurements differentiated the separators more clearly, with the Kauri site again having the highest values. The two Clandeboye separators had the lowest values, and Edendale and Whareroa were in the mid-range.

Potassium differentiates between the Kauri separators and the others. The measurements of total phosphorus replicate the pattern of calcium in Figure 5-13, confirming the perfect correlation between calcium and total phosphorus.

Summary

Significant batch differences were found for all minerals, but the taking of measurements over two different weeks did not account for batch variability. Differences in the contents of calcium, potassium, phosphate and total phosphorus existed between the different sites.

Principal component analysis indicated that differences in calcium and phosphate contents cause most of the variability in batch composition. The principal component plot (Figure 5-12) and the interaction plot (Figure 5-13) graphically demonstrate the ANOVA results. These suggest that milk at the Kauri plant is different from milk in other parts of the country, with the level of calcium being the most important factor in this difference. Phosphate was found to distinguish between separators, with the order from the highest to the lowest phosphate content being Kauri K1, Kauri K2, Edendale, Whareroa, Clandeboye 500 and Clandeboye 300 (Figure 5-13).

The results of individual ANOVA analysis for calcium and phosphate content (normalized by sludge total solids content) are displayed in Appendix 21.

Conclusions

This sludge minerals survey showed that there were clear differences in sludge minerals content, especially the calcium content, between the Kauri site, which is in Northland, and three other sites, one in the lower North Island and two in the South Island; Kauri appears to be unique.

Smaller differences were found between sites and between individual separators, mainly in terms of the sludge phosphate content.

Whether or how these findings relate to sludge discharge port corrosion is unknown. However, given that the corrosion problem is largely confined to Northland, a connection cannot be ruled out. Further investigation is warranted.

6 Overall Discussion and Conclusions, and suggestions for future work

The main conclusion from the research reported here is that the order in which separation and pasteurisation is carried out is not important. There was little information available in the existing literature about the order in which separation and pasteurisation should be performed. The data obtained during this research has filled a hole in knowledge about the effects of the order in which separation and pasteurisation are performed. The research was conducted using a large number of samples, on which a large number of compositional analyses were performed.

It has also been discovered that the separating temperature can be set lower than previously thought, without affecting separator efficiency. The data from both the pilot plant trials and the Fonterra Kauri trials showed that the separating temperature did not have a significant effect on the composition of any of the streams. The effect of separating temperature could not be examined on the K2 (P+S) equipment configuration at Fonterra Kauri owing to the plant configuration.

Further investigation into the effect of using lower separating temperatures should be carried out. Samples should be taken over longer runs to determine microbiological/plant fouling and run time effects.

No interaction effects of separating temperature and equipment configuration were noted in either the Pilot Plant or Fonterra Kauri trials, indicating that they can be varied independently.

The results show that any detectable significant differences in the streams from the two equipment configurations are minor. The data shows that there is a lot more flexibility in running the separation and pasteurisation operations than previously thought.

The pilot plant trials were set up to mimic ideal factory conditions, and were used as a stepping stone before the trials on full-scale plant at the commercial sites. The pilot plant trials did not identify differences between the streams resulting from the two different equipment configurations, in a model factory environment. The Fonterra Kauri trials were then carried out to determine whether the results produced at the model plant were the same as at a commercial plant. It was not possible to compare

pasteurised skims and pasteurised creams from the two plant configurations in the Fonterra Kauri trials, due to the sampling points available. The results analysis was made very difficult by the lack of comparable samples. The trial results displayed that the heat treatment received by the whole milks at the Fonterra Kauri factory was greater than that experienced at the pilot plant, as differences were noted in the whey protein contents of the Fonterra Kauri raw and pasteurised whole milks.

The mineral survey work showed that the mineral content of the separator sludges varies significantly across the country. The site and separator could be identified using the calcium and phosphate contents.

If further work is to be carried out investigating the sludge composition in relation to separator bowl erosion, the experiment design should be refined. More samples should be obtained from each site and separator, in order to facilitate accurate statistical analysis. The samples should also be taken at a time of year when there is good incoming milk flow to the site, to ensure that the equipment will be running, especially if two different equipment configurations are being examined at one site. It should also be ensured that the same separator each time should be sampled from the different sites. More information is required on the processing conditions under which the separator is operating. The amount of flush water used and the desludge period may have a large effect on the sludge composition and volume. Since there are so many variables associated with the separators and the processing conditions under which they operate, care should be taken when selecting equipment to be studied.

7 References

- Anema, S. G., & McKenna, A. B. (1996). Reaction Kinetics of Thermal Denaturation of Whey Proteins in Heated Reconstituted Whole Milk. *Journal of Agricultural and Food Chemistry*, *44*, 422-428.
- Auldust, M. J., Walsh, B. J., & Thomson, N. A. (1998). Seasonal and lactational influences on bovine milk composition in New Zealand. *Journal of Dairy Research*, *65*, 401-411.
- Brooker, B. E. (1978). The Origin, Structure and Occurrence of Corpora amylacea in the Bovine Mammary Gland and in Milk. *Cell and Tissue Research*, *191*, 525-538.
- Chan, N. (2005). Optimisation of the Milk Separation Process.
- Claudon, C., Francin, M., Marchal, E., & Straczeck, J. (1998). Proteic Composition of corpora amylacea in the bovine mammary gland. *Tissue and Cell*, *30*(5), 589-595.
- Dannenberg, F., & Kessler, H.-G. (1988). Reaction Kinetics of the Denaturation of Whey Proteins in Milk. *Journal of Food Science*, *53*(1), 258-263.
- de Wit, J. N. (1998). Nutritional and Functional Characteristics of Whey Proteins in Food Products. *Journal of Dairy Science*, *81*, 597-608.
- Foley, J., & King, J. J. (1977). Influence of Pasteurization Before and After Separation of Cream on the Oxidative Stability of Ripened Cream Butter. *Journal of Food Protection*, *40*(7), 480-483.
- Fox, P. F., & McSweeney, P. L. H. (Eds.). (2003). *Advanced Dairy Chemistry Volume 1 Proteins* (3rd Part A ed.). New York: Kluwer Academic/ Plenum Publishers.
- Gray, I. K. (1988). *Milk Composition: The Gross Composition of Milk and Factors that Influence It*. Paper presented at the Proceedings of Dairy Science summer School - Application of Science to Dairy Manufacture, Palmerston North, New Zealand.
- Guo, C., Campbell, B. E., Chen, K., Lenhoff, A. M., & Velev, O. D. (2003). Casein precipitation equilibria in the presence of calcium ions and phosphates. *Colloids and Surfaces B: Biointerfaces*, *29*, 297-307.
- Holt, C., Hasnain, S. S., & Hukins, D. W. L. (1982). Structure of bovine milk calcium phosphate determined by X-ray Absorption Spectroscopy. *Biochimica et Biophysica Acta*, *719*, 299-303.
- Horne, D. S. (1998). Casein interactions: casting light on the black boxes, the structure in dairy products. *International Dairy Journal*, *8*, 171-177.

-
- Kessler, H.-G., & Beyer, H.-J. (1991). Thermal Denaturation of whey proteins and its effect in dairy technology. *International Journal of Biological Macromolecules*, 13(June), 165 - 173.
- King, D. W., Russell, R. W., McDowell, A. K. R., & Dolby, R. M. (1972). The Effect of Temperature of Separation on Fat Losses and on Butter Quality. *New Zealand Journal of Dairy Science and Technology*, 7(4).
- Kulmyrzaev, A. A., Leveux, D., & Dufour, E. (2005). Front-Face Fluorescence Spectroscopy Allows the Characterization of Mild Heat Treatments Applied to Milk. Relations with the Denaturation of Milk Proteins. *Journal of Agricultural and Food Chemistry*, 53, 502-507.
- Lewis, S. (2003). *Optimal Separation Temperature*. Massey University, Palmerston North.
- Li-Chan, E., Kummer, A., Losso, J. N., Kitts, D. D., & Nakai, S. (1995). Stability of bovine immunoglobulins to thermal treatment and processing. *Food Research International*, 28(1), 9-16.
- Lucisano, M., Pompei, C., Casiraghi, E., & Rizzo, A. M. (1994). Milk Pasteurization: Evaluation of Thermal Damage. *Italian Journal of Food Science*, 6(2), 185 - 197.
- Mainer, G., Sanchez, L., Ena, J. M., & Calvo, M. (1997). Kinetic and Thermodynamic Parameters for Heat Denaturation of Bovine Milk IgG, IgA and IgM. *Journal of Food Science*, 62(5), 1034 - 1038.
- McCarthy, O. J. Centrifugal Separation in the Dairy Industry. Massey University Study Guide (2005)
- Morales, F.-J., Romero, C., & Jimenez-Perez, S. (2000). Characterization of industrial processed milk by analysis of heat-induced changes. *International Journal of Food Science and Technology*, 35, 193-200.
- Mortier, L., Braekman, A., Cartuyvels, D., Renterghem, R. V., & Block, J. D. (2000). Intrinsic indicators for monitoring heat damage of consumption milk. *Biotechnology, Agronomy, Society and Environment*, 4(4), 221-225.
- Oldfield, D. J. (1996). Heat-Induced Whey Protein Reactions in Milk - Kinetics of Denaturation and Aggregation as related to milk powder manufacture. Massey University, Palmerston North.
- Phadungath, C. (2005). Casein micelle structure: a concise review. *Songklanakarin Journal of Science and Technology*, 27(1), 201-212.
- Reid, I. M. (1972). Corpora Amylacea of the Bovine Mammary Gland - Histochemical and Electron Microscopic Evidence for the Amyloid Nature. *Journal of Comparative Pathology*, 82.

-
- Sanchez, L., Peiro, J. M., Castillo, H., Perez, M. D., & Calvo, M. (1992). Kinetic Parameters for Denaturation of Bovine Milk Lactoferrin. *Journal of Food Science*, 57(4), 837-879.
- Sordillo, L. M., & Nickerson, S. C. (1986). Growth Patterns and Histochemical Characterization of Bovine Mammary Corpora Amlyacea. *Journal of Histochemistry and Cytochemistry*, 34(5), 593-597.
- Vega-Warner, A. V., Gandhi, H., Smith, D. M., & Ustunol, Z. (2000). Polyclonal-Antibody-Based ELISA to detect Milk Alkaline Phosphotase. *Journal of Agricultural and Food Chemistry*, 48, 2087 - 2091.
- Walstra, P., & Jenness, R. (1984). *Dairy Chemistry and Physics*: John Wiley & Sons (A Wiley-Interscience publication).
- Westfalia Separator Food Tec. (2000). *Separators for the Dairy Industry*: Westfalia Separator Food Tec GmbH.
- Zhang, Z., & Aoki, T. (1996). Behaviour of calcium and phosphate in bovine casein micelles. *International Dairy Journal*, 6(8/9).

Appendix 1 Pilot Plant trials – Whole Milk – Raw Data

Please refer to cd.

Appendix 2 Pilot Plant trials – Whole Milk - ANOVA

Please refer to cd

Appendix 3 Pilot Plant trials – Skim Milk – Raw Data

Please refer to cd.

Appendix 4 Pilot Plant trials – Skim Milk - ANOVA

Please refer to cd

Appendix 5 Pilot Plant trials – Cream – Raw Data

Please refer to cd.

Appendix 6 Pilot Plant trials – Cream - ANOVA

Please refer to cd

Appendix 7 Pilot Plant trials – Sludge – Raw Data

Please refer to cd.

Appendix 8 Pilot Plant trials – Sludges - ANOVA

Please refer to cd

**Appendix 9 Pilot Plant Trials – Separating Efficiency
Calculations**

Please refer to cd

Appendix 10 Fonterra Kauri trials – Whole Milk – Raw Data

Please refer to cd.

Appendix 11 Fonterra Kauri trials – Whole Milks - ANOVA

Please refer to cd

Appendix 12 Fonterra Kauri trials – Skim Milk – Raw Data

Please refer to cd.

Appendix 13 Fonterra Kauri trials – Skim Milk - ANOVA

Please refer to cd

Appendix 14 Fonterra Kauri trials – Cream – Raw Data

Please refer to cd.

Appendix 15 Fonterra Kauri trials – Cream - ANOVA

Please refer to cd

Appendix 16 Fonterra Kauri trials – Sludge – Raw Data

Please refer to cd.

Appendix 17 Fonterra Kauri trials – Sludge - ANOVA

Please refer to cd

Appendix 18 Mineral Survey – Whole Milk – Raw Data

Please refer to cd.

Appendix 19 Mineral Survey – Sludge – Raw Data

Please refer to cd.

Appendix 20 Mineral Survey – Sludge - ANOVA

Please refer to cd

**Appendix 21 Mineral Survey – Sludge – Individual ANOVA
analysis for Calcium and Phosphate content (normalised by
sludge total solids content)**

Please refer to cd